

**SOF 15th ANNIVERSARY
EXPANDED ISSUE**

SOLDIER OF FORTUNE

The Journal of Professional Adventurers

OCTOBER 1990
48493

ALL NEW!

**SOF REPORTS:
AFGHANISTAN
ECUADOR
LIBERIA
SURINAME**

PLUS:

**DELTA FORCE
IN PANAMA**

**SWAT
OLYMPICS**

**BASE
JUMPING**

**SEALS IN
VIETNAM**

**SOF'S
WORLD AT
WAR**

**AND MUCH
MORE!**

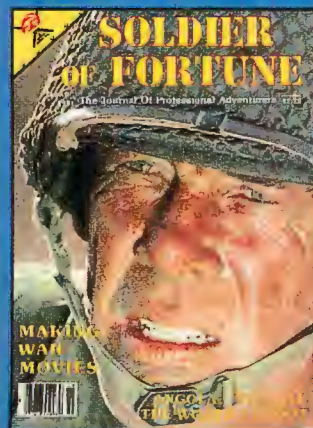
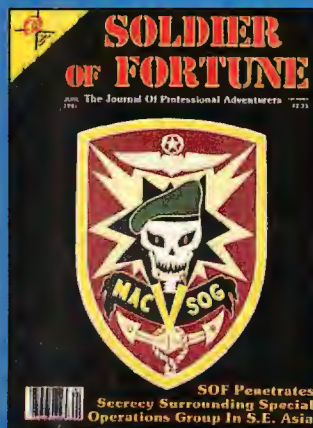
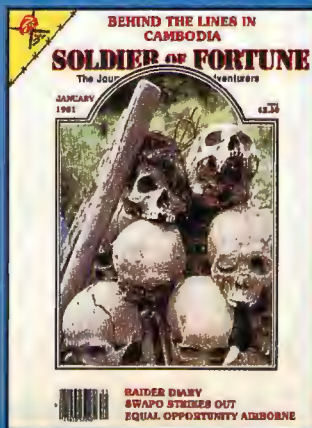
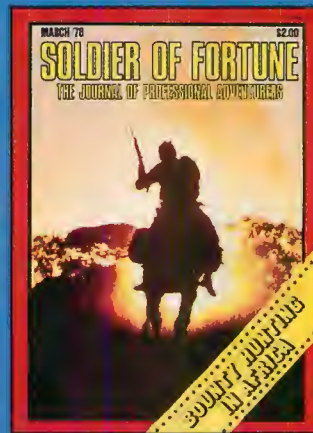
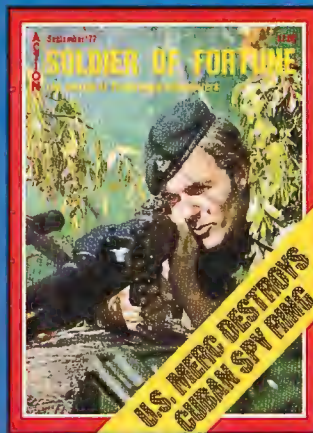

10
0 09128 48493 8
U.S. \$4.95 • UK £2.60 • CAN. \$5.75

SOLDIER OF FORTUNE

OCTOBER 1990

THE ADVENTURE'S JUST BEGINNING...

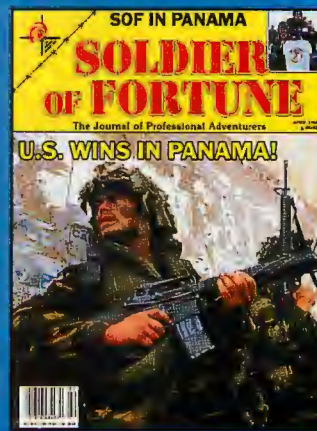
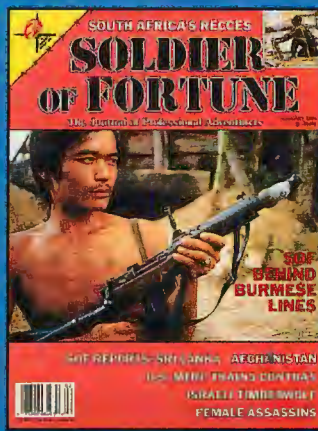
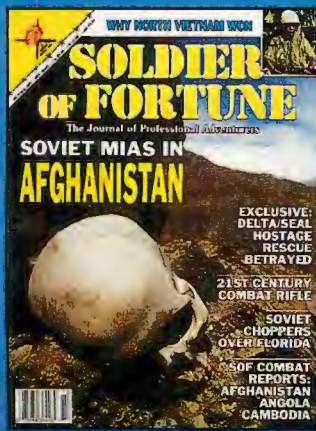
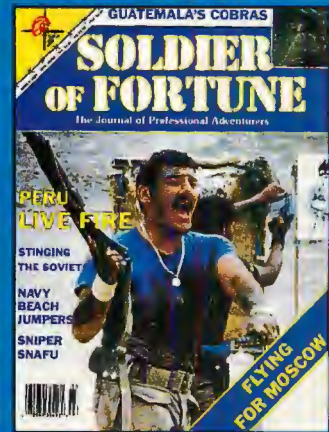
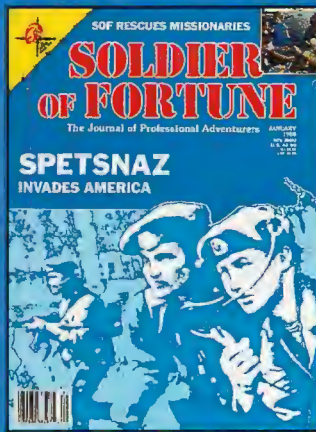
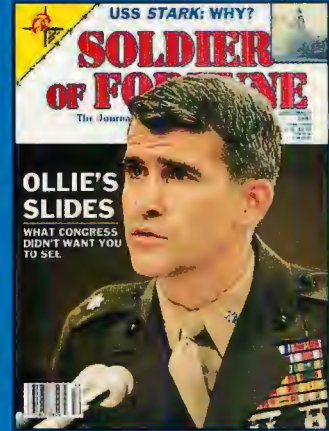
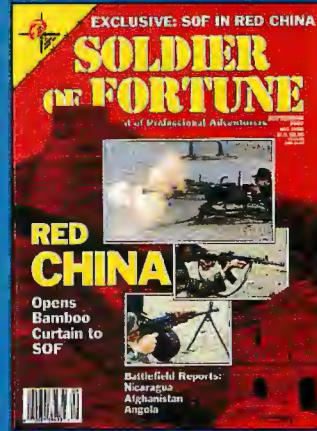
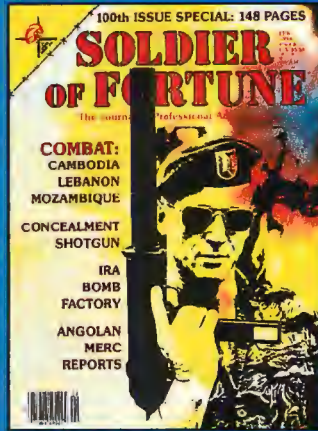
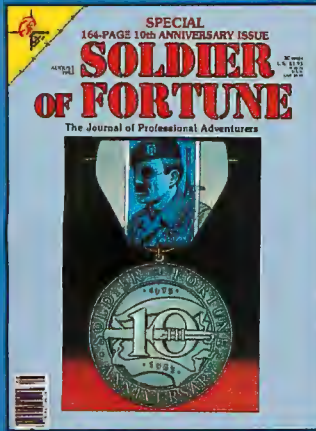
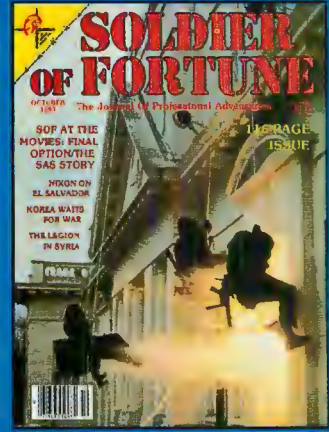
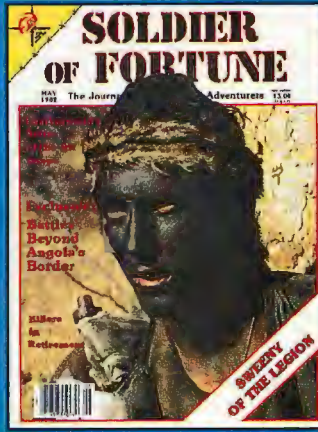
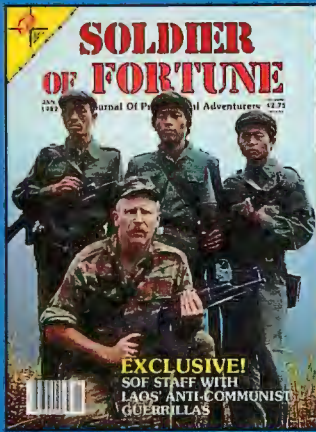

THIS IS IT!! SOF'S SWEEPSTAKES

ENTER TODAY!

All Entries Must Be Postmarked By
Dec. 12, 1990
NO PURCHASE NECESSARY



If card is missing, cut out coupon and mail to:
Soldier of Fortune, PO BOX 348, MT MORRIS, IL 61054-9984

YES!

I want to celebrate your 15th year
with a chance at some great prizes
and an incredible 58%-plus savings*
on adventure packed SOF!

- Enter my name and send me a 1-yr. sub. for **\$19.90**
- Enter my name and send me a 2-yr. sub. for **\$34.90**
- Enter my name in the Sweepstakes only.
- New subscription** **Renewal**
(If current subscriber, please attach label)
- Payment enclosed (U.S. funds only)
- Mastercard Visa Exp. date _____
- Card # _____
- Signature _____
- NAME _____
- ADDRESS _____
- CITY _____ STATE _____ ZIP _____
- DAY PHONE (____) _____ EVE (____) _____

If for any reason you're dissatisfied,
cancel your subscription and
we'll refund the unused balance.

BSWA0C

*Savings based on annual newsstand rate of \$47.40

POSTMARK DEADLINE: December 12, 1990
SWEEPSTAKES DRAWING: January 31, 1991

(Payment must accompany order. Offer good in U.S. only. All other countries add \$21. year additional postage.) Please allow 6-8 weeks for first issue. THIS OFFER EXPIRES 12/12/90.

(SEE ATTACHED SWEEPSTAKES RULES)

\$19.90 in 1990!

THE adventure journal for the
'90s is celebrating 15 great
years and invites YOU to be a
part of the action! Go for huge
savings on SOF and a shot at
these fabulous PRIZES!

How To Enter

Fill out entry card (or coupon) and send to SOF via U.S. mail with entry postmarked no later than December 12, 1990. No entries will be accepted after this closing date. Winners will be selected by random drawing on January 31, 1991, and will be notified by mail or telephone. No purchase necessary to enter. All prize winners must comply with Federal, State and local firearms regulations, where applicable. Judges' decisions final. Sweepstakes open to residents of the U.S. 18 years of age or older. Rifle winners must be 18 and furnish SOF with a Federal Firearms License to ship prize. Prizes non-transferable. Odds of winning dependent upon total number of entries. List of winners will be printed in a future issue of *Soldier of Fortune*.

1975



1990

Grand Prize

THE ACTION TRIP OF A LIFETIME! WIN A TRIP TO THE 12TH ANNUAL SOF CONVENTION IN SEPTEMBER 1991 THAT INCLUDES:

- Up to five nights' stay at the Sahara
- \$1,000 spending money
- Round-trip airfare for two from anywhere in the continental U.S.
- Admittance to the expo hall for the three-day show and banquet
- Plus, many more convention privileges —FREE!



Second Prize

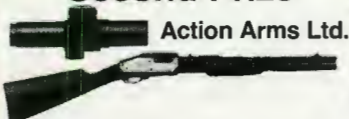

The Classic Woods Rifle: The Timber Wolf. This beautiful and unique carbine features several firsts, the most notable being it's the first and only pump-action centerfire rifle chambered in .357 magnum. With the Timber Wolf comes the incredible Ultra Dot red dot aiming system with mount.

Third Prize

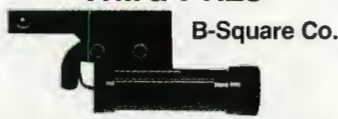

BSL-1, the world's easiest, most accurate system in a laser sight ever developed. Electronically advanced, the BSL-1 is 35% smaller than its nearest competitor. Many outstanding features including 2' dot visibility at 200 yards. Mounting system included.

Fourth Prize

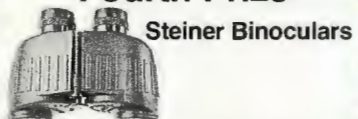

From the world's largest producer of military binoculars comes the 7x35G Military-Marine binoculars. Top-of-the-line features include wide angle (525'/1000 yards), sharp 20 yards to infinity auto-focus system, and more. Look for the "Steiner" ad in this and other issues.

Fifth Prize

Mitchell Arms, Inc.



The AK-22, an amazingly accurate and faithful copy of the original AK-47 rifle. Hard to tell from the original, the AK-22 is produced in 22 caliber with the same feel and heft as the AK-47.

Sixth Prize

Al Mar Knives



Wild, tough and free is the spirit behind this beautiful "Alaskan" Bowie, the coldest piece of steel you'll ever own. Influenced by American and English designs, 17 1/4" long, this piece has legendary feel and comfort. Titanwood handle.

Seventh Prize

Barnett International, Inc.



Wildcat XL, the world's best selling crossbow! A favorite of hunters and target shooters because of design, balance, power, reliability and special features including the performance-improving Veloci-speed prod.

Eighth Prize

Aimpoint



From the makers of the world's finest electronic red dot sights, the series 1000 is compact, lightweight, and built to withstand the most demanding conditions. Optimal performance and reliability. Mounting system included.

Ninth Prize

Outdoor Edge Cutlery Corp.



This beautiful, limited edition Game Skinner knife is serial number 001 of 020 with SOF's 15th Anniversary logo etched into the blade. Handsome walnut and glass display case included.

Tenth Prize

Collector's Armoury, Inc.



The top gun for today's top executive—the Model 1883 Gatling Gun! This faithfully recreated, historical reproduction makes a classic display for desk or sideboard. Extremely detailed.



\$19.90

ONCE IN A LIFETIME

Special Anniversary Offer

DON'T MISS OUT!

ACT NOW!

YES!

I want to celebrate your 15th year with a chance at some great prizes and an incredible 58%-plus savings* on adventure-packed SOF!

Enter my name and send me a 1-yr. sub. for \$19.90

Enter my name and send me a 2-yr. sub. for \$34.90

Enter my name in the Sweepstakes only.

New subscription Renewal

(If current subscriber, please attach label)

Payment enclosed (U.S. funds only)

Mastercard Visa Exp. date _____

Card # _____

Signature _____

NAME _____

ADDRESS _____

CITY _____ STATE _____ ZIP _____

DAY PHONE (____) _____ EVE (____) _____

If for any reason you're dissatisfied, cancel your subscription and we'll refund the unused balance.

BSWA0E

*Savings based on annual newsstand rate of \$47.40

POSTMARK DEADLINE: December 12, 1990

SWEEPSTAKES DRAWING: January 31, 1991

(Payment must accompany order. Offer good in U.S. only. All other countries add \$21. year additional postage.) Please allow 6-8 weeks for first issue. THIS OFFER EXPIRES 12/12/90.

(SEE ATTACHED SWEEPSTAKES RULES)



SOF

FIFTEENTH ANNIVERSARY CELEBRATION

1500 SWEEPSTAKES

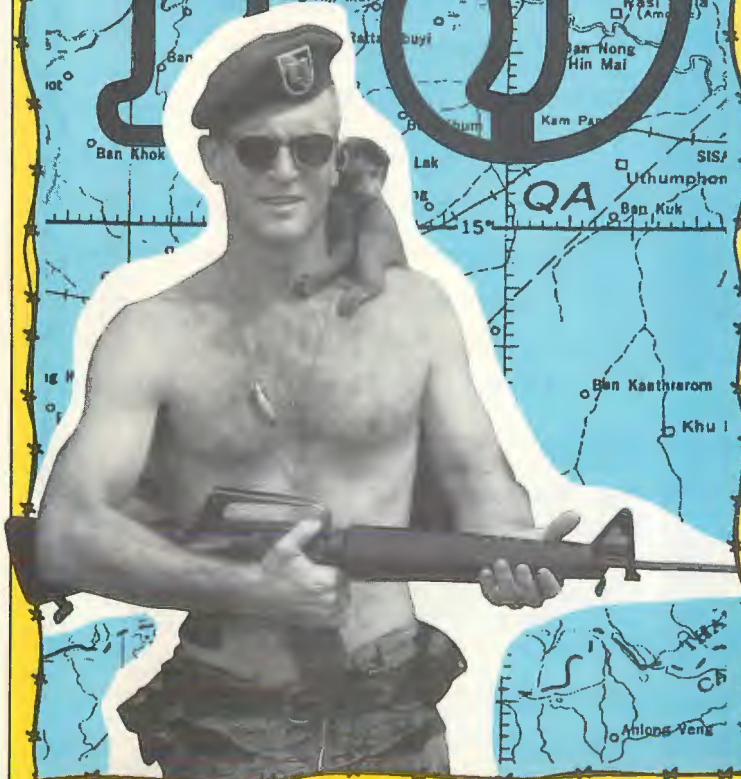

**SOLDIER OF
FORTUNE**
PO BOX 348
MT MORRIS IL 61054-9984

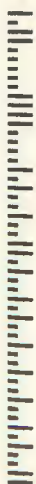

BUSINESS REPLY MAIL

FIRST CLASS MAIL

PERMIT NO. 8

MT. MORRIS, IL

POSTAGE WILL BE PAID BY ADDRESSEE



NO POSTAGE
NECESSARY
IF MAILED
IN THE
UNITED STATES



FREE DANNER BOOT CATALOG



Select your new boots from our detailed full-color catalog, showing the complete selection of styles and sizes.

Call us toll-free:

1-800-345-0430

from 9 to 4 Pacific time, or mail this card today for your FREE Danner Catalog.

Name ^{SF}

Phone #

Address

City

State

Zip

COMMAND GUIDANCE

by Robert K. Brown

MAGAZINE STAFF

Editor/Publisher Robert K. Brown
Managing Editor John Coleman
Senior Editor Don McLean
Technical Editor Peter G. Kokalis
Associate Editors S. Max
..... Tom Slizewski
..... Paul Danish

Production Manager Kathleen Allard
Art/Production Assistant ... Linda Keschl
Electronic Graphics/
Layout Deborah Homer

Foreign Correspondents

Senior Foreign Correspondent Steve Salisbury
• Tom Marks • Mike Winchester • Peter Douglas • Jake
Border • George Jones

Contributing Editors

• *Vietnam Veterans Affairs* Col. Chuck Allen • *Military
History* William Brooks William H. Northacker • *Uncon-
ventional Operations* Brig. Gen. Heine Aderholt James
P. Monaghan Maj. Robert MacKenzie • *Military Affairs*
Alexander McColl Mike Williams • *Paramedic Opera-
tions* Dr. John Peters • *Explosives/Demolitions* John
Donovan • *Aviation* Dana Drenkowski • *Africa* Al Venter
• *Outdoor Affairs* Galen Geer • *Latin America* Hugo
Hartenstein

Advertising/Marketing/

Expo Director John Bresslem

Administrative/Convention

Assistant Dianne McLeod

Circulation T. (Lefty) Wilson
..... Janice Brown

Business Manager

& Controller Terri A. Matera

Bookkeeper Sharon Windsor

SOF Exchange Carole Hayden

Mail/Warehouseman Jeff Bergeon

Special Projects Coordinator . John Kreiger

In Memoriam

Craig Nunn — Art Director • Lance Motley — Foreign
Correspondent • Barry Sadler — Contributing Editor

NOTICE: SOLDIER OF FORTUNE Magazine is a magazine of national and international distribution. There may be products for which sale, possession or interstate transportation may be restricted, prohibited or subject to special licensing requirements in your state. Purchasers should consult the local law enforcement authorities in their area. All data in this publication, technical or otherwise, is based upon personal experience or individuals using specific tools, products, equipment and components under particular conditions and circumstances, some of which may not be reported in the article and which Soldier of Fortune has not otherwise verified. Soldier of Fortune, its agents, officers and employees disclaim any responsibility for all liability, injuries or damages.

SOLDIER of Fortune marks its 15th anniversary this month. For the past decade and a half we've made it our business to bear witness for those who have waged war against tyranny, and in discharging that mission we've printed dispatches from battlefields across the globe. During that time the world was said to be at peace.

Many things have changed in 15 years, but one thing has not: Those who would be free will sooner or later be required to fight for their liberty. It is the natural order of things. The world never runs out of assholes.

There are those who claim otherwise. They maintain the upheavals in the Soviet Bloc mark "the end of history," a time in which war will be obsolete, because there is nothing left to fight over.

That's a pleasant delusion, but it doesn't square with the facts.

As these words are written, people worldwide are still pointing rifles and pulling triggers and killing each other with frenzied urgency. Their idea of "peace" means, simply, that there are no more enemies left to kill.

The wars in Afghanistan, Angola, and Cambodia did not end with the withdrawal of Soviet, Cuban, and Vietnamese expeditionary forces. Nor are they apt to end any time soon.

The Ethiopian civil war rages as fiercely as ever. The Sri Lankan army is conducting an offensive against the Tamil Tigers. A new war is smoldering in Kashmir. Old ones smolder in Burma and Laos. Warlords continue to fight over the corpse of Lebanon.

No one has told the New People's Army in the Philippines, the Sendero Luminoso in Peru, or the FMLN in El Salvador that communism has failed. No one has told Renamo in Mozambique, Polisario in Morocco, ORPA in Guatemala, or the scores of separatists, tribal factions or nationalists that armed conflict is an obsolete way of solving disputes.

The war on drugs is swiftly becoming a war with revolutionaries who finance their revolutions with narco-dollars. And it is increasingly being fought by elite military and paramilitary forces in both the producing countries and the United States.

Old hatreds are boiling up as the Soviet Union's component republics reassert their national identities.

History has not ended, nor will it. We will be there as it is made.

It has been the deeply held belief of the correspondents we have sent to the world's battlefields that the story of men in battle could not be truthfully told from behind the lines. They have considered it their duty to go to the sharp end. Five of them — Lance Motley, George Bacon, Peter Bertie, Almerigo Griz and Mike Echanis — have been killed there. Telling the truth has its price.

SOF will continue to report, as completely, accurately, and truthfully as we know how, the news of men and women at war. We will also cover the new threats that have emerged at home: the war against narco-terror along the border and in the cities, the war against terrorists who value the lives of animals more highly than the lives of humans, and the war against those who would subvert the Second Amendment and disarm the American people.

We do not pretend to be neutral observers. We stand with those who fight for freedom. We will be at the sharp end. ✕

SOLDIER OF FORTUNE (ISSN 0145-6784/USPS 120-510) is published monthly by SOLDIER OF FORTUNE Magazine, Inc., Boulder, Colorado. Second Class Postage Paid at Boulder, CO. POSTMASTER: Send address changes to SOLDIER OF FORTUNE, Subscription Department, P.O. Box 348, Mt. Morris, IL 61054. U.S. subscription rates for twelve monthly issues: \$28.00. All foreign subscriptions add \$21.00. U.S. FUNDS ONLY. Single-Issue Price — U.S., \$3.95; United Kingdom, £2.60; Canada, \$4.50.

CONTRIBUTORS: Manuscripts, photographs, drawings are submitted at the contributor's own risk. Material should be mailed to Articles Editor, SOLDIER OF FORTUNE, P.O. Box 693, Boulder, CO 80306, and cannot be returned unless accompanied by sufficient postage. Any material accepted is subject to such revision as is necessary to meet the editorial requirements of SOF. All manuscripts must be typed double-spaced. All photographs should be credited and be accurately identified. Payment will be made at rates current at time of publication. Editorial office phone number is 303-449-3750.

Copyright © 1990 by SOLDIER OF FORTUNE Magazine, Inc. All Rights Reserved.

SOF

FEATURES



SOF Tech Scoops — Page 74

MOST WANTED SOF Staff
U.S. Customs is offering up to \$50,000 for one Gustavo J. Fernandez. Have you seen him? **26**

THE GOOD, THE BAD, AND THE UGLY SOF Staff
SOF's 1990 staff **32**

WORLD AT WAR SOF Staff
SOF has gone and done more during the last 15 years than most people do in a lifetime. Our growing stable of 100-plus writers, editors, and professional adventurers will keep bringing you the stories others can't — or won't **38**

PROFILE IN COURAGE Morgan Tanner
SEAL-turned-cop uses his training to win police department's highest commendation — the Medal of Honor **43**

JUST CAUSE JAILBREAK Neil Livingstone
American pirate radio broadcaster Kurt Muse was nabbed and imprisoned in Noriega's infamous Modelo Prison just prior to Operation Just Cause. Threatened with death, he was lucky Delta Force decided to drop in **44**

FLASHPOINT LIBERIA Thom Green
Yank journalist is caught up in a bloody African revolution — complete with an American mercenary. Here's his report straight from the capital **48**

OUTLAW JUMPERS Peter Douglas
Parachutists looking for the ultimate thrill have invented BASE (Building, Aerial, Span, Earth) jumping to satisfy their need to live dangerously. Are you ready to stand on the edge? **54**

NO HONOR AMONG MERCS Peter Douglas
Deceit and treachery equals death in Suriname's jungle. SOF brings you this exclusive first-hand account of the Brit mercs who lived to talk about it **60**

SOF TRAINS CONTRAS UNDER ROCKETS'

RED GLARE Harry Claffin
At last, the inside story of how General Singlaub recruited "a few American trainers" to help the contras **68**

SOF TECH

SCOOPS Peter G. Kokalis
Our Tech Editor recounts 15 years of exclusive weapons coups SOF's scored around the world **74**

FROM AFGHANISTAN, WITH

LOVE ... General Rahmatullah Safi
In the wake of the freedom fighters' victory over the Soviet Union, one mujahideen general writes a letter of thanks for SOF's role **80**



SOF Trains Contras — Page 68

IN MEMORIAM:

CRAIG NUNN Jim Graves
Farewell to a Brother in Arms **81**

DANGEROUS

LIAISONS James Renner
Westerners trying to help in Afghanistan have found themselves caught up in fights they don't understand — and many have paid with their lives **82**



Suriname's Jungle — Page 60



General Safi — Page 80

COLUMNS

| | |
|---|-----|
| Command Guidance | 1 |
| Bulletin Board | 4 |
| World Sitrep | 8 |
| Full Auto | 12 |
| <i>Flechette fantasies</i> | |
| I Was There | 16 |
| <i>Camperland</i> | |
| FLAK | 21 |
| In Review | 30 |
| <i>Warriors</i> | |
| <i>38 North Yankee</i> | |
| <i>and other books too good to miss</i> | |
| Combat Craft | 35 |
| <i>Raids</i> | |
| Supply Locker | 134 |
| Classified | 139 |
| Advertisers Index | 143 |



BASE Jumping — Page 54

COVER

Soldier of Fortune Magazine has prospered the last 15 years because we go where others fear to tread. As this montage of past covers shows, we've continually put ourselves in the front lines of freedom across the globe, oftentimes at great risk, but always with the thought that you deserve to know the truth. Whether it's covering little-known wars, or in support of freedom fighters around the world, or in the quest of technical or intelligence scoops, or our fight for the rights of veterans and gun owners — SOF will continue to walk the point.

AO: FOREST OF ASSASSINS Steven Edwards
On their first outing, SEAL Whiskey Platoon mounted a POW rescue mission into Vietnam's Delta. Confidence was high, and so were the stakes **86**

SWAT OLYMPICS Morgan Tanner
Twenty-six Special Weapons And Tactics teams met in Georgia to do battle for the right to call themselves the best **90**

WHO DARES WINS C.R. McQuiston
While the CIA and State Department sat idle, an American intelligence officer took action and masterminded a successful coup in Ecuador. The story's never been told — until now **96**

"WHAT'S A WOMAN DOING HERE" Neil Livingstone and Barbara Newman
War correspondent Dickey Chapelle braved the odds for 7,300 days, two wars, and four revolutions — until the odds caught up with her **100**

BUILDING A BETTER M16 Peter G. Kokalis
Eagle Arms' EA15E2 steps in where Colt fears to tread **102**

BULLETIN BOARD



SOF's triumphant (they all finished the race) competitors in the 10k 1990 Bolder Boulder were from left Kathy Allard, Alex McColl, John Coleman, Bob Brown, Dianne McLeod.

BYTING THE BULLET ... Mayor McEnery of San Jose, California, recently returned from Costa Rica, where he and President Oscar Arias cooked up a "Bullets for Bytes" program. The gist of it is, they want to collect the weapons of Central America which would be melted down and used to make commemorative plaques. The plaques would then be given to Silicon Valley donors in exchange for computers for Central American school children. A memo from police chief Joseph D. McNamara noted that "the mayor's office is attempting to identify Spanish speaking officers from Central America who have their ancestry in Honduras, Guatemala, El Salvador, Belize, Nicaragua, Costa Rica or Panama, and who may be interested in becoming involved in this worthwhile program." We suggest it would be more appropriate to give these weapons to the contras, and we'll pass the hat to buy computers for the kids.

MEDALS FOR MAGGIE ... Every GI's sweetheart Martha Raye has never received national recognition for all her work in World War II, Korea or Vietnam, but there's a drive afoot to award her the Presidential Medal of Freedom. About time! You can help by providing Maggie photos, Maggie stories, by circulating petitions and organizing. Contact 1Sgt Noonie Fortin, 1 Midway Drive, Dept. SOF, Albany, NY 12205 and see what *you* can do for Maggie.

TERRORIST REWARD NOW \$2 MILLION ... Maximum reward from Uncle Sam for alert individuals who provide information that helps thwart a terrorist act has been quadrupled from \$500,000 to \$2 million by legislation signed into law by President Bush. Persons with information about a planned terrorist act should call the nearest U.S. Embassy or Consulate if overseas, or the FBI if they are in the United States.

MERC CONTACTS, CONTRACTS ... Every now and then somebody asks, so every now and then we must reply: (1) Recruiting within the United States for the armed forces of any foreign government or movement is a felony, so we don't do it or facilitate it; (2) With the exception of the French Foreign Legion, there are currently few jobs for mercs, and most of those are for pilots, mechanics and technicians or people with real reputations in the security field — and most of those are filled through the "old boys net"; (3) SOF has neither contacts nor inclination to get people out of jail and into jobs as mercs; (4) Your best bet for solid military training is to enlist in a regular armed service; two-week schools can only teach you to be a corpse.

TREE SNAKE MIGRATING ... Concern is that poisonous brown tree snakes, native to Australia, will spread from Guam where they have decimated the local bird population, to other islands such as Hawaii. Already caught hitchhiking on military planes, luckily frozen to death on high-altitude flights.

Come ski with SOF! Drop a line to Ski SOF (Box 693, Boulder CO 80306) for an information packet on how you can join the SOF Ski Team for a week at Keystone Resort in Colorado during the '90-'91 season. Ski with SOF's team of Bob Brown, Mike McPike, Mike Williams and Phil Fanshaw. Accomplished skiers and tyros welcome; instruction will be available, as will downhill races (NASTAR format). Great skiing in great company in the grand Colorado Rockies. Info packets also available from Mike McPike or Alex McColl at the Special Projects booth at SOF convention in Las Vegas. Last season in NASTAR competition Brown won two silver and two bronze medals, Williams two silver, McPike two bronze, and Fanshaw two silver. Photo: Summit Photography



PALADIN PRESS



BAIL ENFORCER

The Advanced Bounty Hunter

by Bob Burton

No prey is as wily and dangerous as a hunted man. It takes a special breed, equally cunning, to track the fugitive down and bring him to justice. It takes a professional bounty hunter. Bob Burton is one of the most successful bounty hunters in America. As a follow-up to his best-selling book, **Bounty Hunter**, Burton shares subtle details of the trade that only someone who has hunted humans on the streets, down alleys and into drug dens could know. You'll get inside info on obtaining an arrest contract, the right clothing for a bust, hunting tricks of the trade, surveillance tips, working with the police, hazards of the use of deadly force, your arrest and how to avoid it and much more. The text is highlighted with photos and stories from Burton's thousands of arrests. Appendices include necessary forms and three invaluable, hard-to-obtain legal studies documenting the precedents of past court decisions regarding the bail enforcement profession. 5 1/2 x 8 1/2, softcover, photos, 216 pp. **\$16.95**

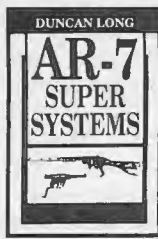
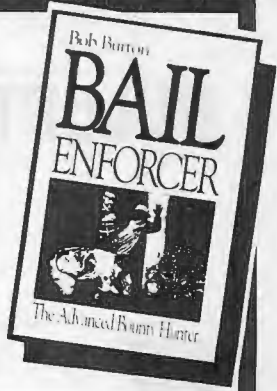

AR-7 SUPER SYSTEMS
by Duncan Long
The lightweight, rugged AR-7 has long been a favorite of hunters, explorers, survivalists and U.S. Air Force pilots. Now Duncan Long reveals his secrets about this classic rifle and the Explorer II. Learn how to upgrade this weapon with custom and do-it-yourself modifications, how to field-strip and detail-strip, how to buy one used, and its value as a collector's item. 5 1/2 x 8 1/2, softcover, photos, illus., 144 pp. **\$15.00**



U.S. NAVY SEAL COMBAT MANUAL
One of the rarest FMs in the field of military collecting, with special emphasis on underwater demolition techniques and explosives. Equipment and tactics employed by this elite fighting force are covered, as are SEAL weapons, communications, diving, infiltration and exfiltration, survival and more. 8 1/2 x 11, softcover, photos, illus., 240 pp. **\$14.95**



SEALS IN VIETNAM
An Inside Look
In the jungles and canals of Vietnam, U.S. Navy SEALs waged a war of terror against the Vietcong. This action-packed video shows SEALs in training, preparing for missions and hauling in terrified VC prisoners. Voice-overs of SEAL veterans tell you what it was like to go out on deadly excursions deep into enemy territory and the special skills it took to get back alive. Color, approx. 30 min., VHS only. **\$29.95**



STREET LETHAL
Unarmed Urban Combat
by Sammy Franco
Want to survive a real streetfight? The fancy leaping kicks and pre-planned responses taught in traditional martial arts will not work on today's city streets. Discover Contemporary Fighting Arts, a hard-hitting combat system that ends streetfights quickly. 5 1/2 x 8 1/2, softcover, photos, 192 pp. **\$15.95**



GET EVEN
The Complete Book of Dirty Tricks
by George Hayduke
A hilarious overview of the methods people use to get even with big business, government and enemies. These dirty tricks range from the simple to the elaborate, including more sophisticated schemes devised by CIA and Mafia members and political dirty tricksters. For entertainment only. 5 1/2 x 8 1/2, hardcover, 208 pp. **\$17.95**



SEALS UDT/SEAL Operations in Vietnam
by T.L. Bosiljavec
The definitive book on U.S. Navy SEALs' role in Vietnam. Accounts of combat missions reveal incredible acts of skill and valor by SEAL troops under fire. Sixteen pages of rare photos show SEALs in training, on patrol in VC territory and moving up canals in the Mekong Delta. 5 1/2 x 8 1/2, hardcover, photos, 272 pp. **\$24.95**

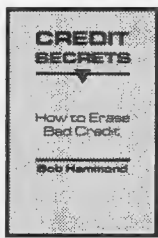

CREDIT SECRETS
How to Erase Bad Credit
by Bob Hammond
Solve your financial problems once and for all! These proven methods show how to eliminate debts and establish a perfect credit rating. Discover the inside tricks used by lawyers and professional credit consultants with this easy-to-follow program. 5 1/2 x 8 1/2, softcover, 80 pp. **\$12.00**

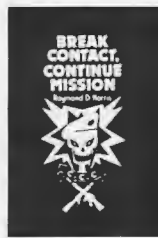

BREAK CONTACT, CONTINUE MISSION
by Raymond D. Harris
A widely praised account of the shadow war fought by MACV-SOG in Laos, Cambodia and North Vietnam. SOG vet Ray Harris tells the story of Ted Garner, a recon sergeant running missions out of the CCC compound, who discovers the truth behind the SOG motto: "You have never lived until you've almost died." 5 1/2 x 8 1/2, hardcover, fiction, 368 pp. **\$22.95**



MAKE MY DAY!
Hayduke's Best Revenge Techniques for the Punks in Your Life
Hayduke is back and meaner than ever with this all-new bag of bully-busting tricks. Hundreds of ideas from readers who rallied to George's stirring cry ("Do unto others before they do unto you") fill this antic anthology that will amaze and amuse you. **Make My Day!** is for entertainment only. 5 1/2 x 8 1/2, hardcover, 224 pp. **\$17.95**



U.S. NAVY SEALS
World War II - Korea - Vietnam Middle East - Grenada - Panama
Elite warriors of stealth, sabotage and silent missions of death, SEALs have been the U.S. military's shock force in 50 years of global conflict. In this new video release, you'll see rare footage of SEALs in action from WWII to today's "dirty little wars." Much of this material has never been available to the public... until now. Color, approx. 35 min., VHS only. **\$29.95**



TO RIDE, SHOOT STRAIGHT, AND SPEAK THE TRUTH
by Jeff Cooper
Combat mind-set, proper sighting, tactical residential architecture, nuclear war - these are some of the many subjects explored by Jeff Cooper in this illustrated anthology. The author discusses various arms, fighting skills and the importance of knowing how to defend oneself, and one's honor, in our rapidly changing world. 5 1/2 x 8 1/2, hardcover, illus., 384 pp. **\$26.00**



MUG SHOTS
A Police Artist's Guide to Remembering Faces
by Douglas P. Hinkle
For anyone who has a need to see beyond the obvious, to pierce disguises or to identify persons who may wish to remain unrecognized, this book provides precise instruction in the techniques of identifying faces, as well as a fascinating glimpse into the criminal mind. It'll change the way you look at faces. 5 1/2 x 8 1/2, softcover, photos, illus., 128 pp. **\$16.00**

OTHER FASCINATING TITLES

- AK47: THE COMPLETE KALASHNIKOV FAMILY OF ASSAULT RIFLES\$14.00
- SWAT TRAINING & EMPLOYMENT\$14.00
- SURREPTITIOUS ENTRY\$16.95
- MAKE 'EM PAY!\$17.95
- PUT 'EM DOWN, TAKE 'EM OUT!.....\$ 8.00
- KAMIKAZE FIGHTING.....\$15.95
- CODEMASTER.....\$16.00
- PAYBACK!.....\$17.95

- U.S. ARMY SPECIAL FORCES MEDICAL HANDBOOK.....\$19.95
- SCREW UNTO OTHERS.....\$17.95
- U.S. ARMY SPECIAL FORCES A-TEAM VIETNAM COMBAT MANUAL.....\$19.95
- BOUNTY HUNTER.....\$12.00
- SWITCHBLADE.....\$10.00
- AR-15/M16 SUPER SYSTEMS.....\$19.95
- HOW TO FIND ANYONE, ANYWHERE.....\$19.95

MONEY-BACK GUARANTEE — DEALER INQUIRIES INVITED
Paladin Press • P.O. Box 1307 • Boulder, CO 80306 • (303)443-7250



PALADIN PRESS
P.O. Box 1307-OJS
Boulder, CO 80306

CREDIT CARD ORDERS CALL TOLL FREE

1-800-642-8300, EXT. 24
Call 24 hours a day, 7 days a week, from any state but Alaska. Send \$1.00 for 50-page CATALOG of 300 titles (free with order).

PLEASE SEND ME THE FOLLOWING TITLES:

VISA MASTERCARD EXP. _____

CARD# _____

CHECK / MONEY ORDER

NAME _____ SUBTOTAL _____

ADDRESS _____ PLEASE INCLUDE POSTAGE & HANDLING \$ 3.50

CITY _____ STATE _____ ZIP _____ TOTAL _____

BULLETIN BOARD



ADMIRAL POINDEXTER, COLONEL NORTH ... Two good men who served their country selflessly and got spit for thanks now must carry their cases through the appeals process. It's hard to compete with the several millions the Office of the Special Prosecutor has *already* spent on this witch hunt — and the millions more they are prepared to spend — especially if you must do it on a military pension. Need we say more?

Poindexter Defense Fund, Dept. SOF, c/o Admiral Mark Hill, Jr., 1322 MerryRidge Rd., McLean, VA 22101
Colonel North Defense Fund, Dept. SOF, P.O. Box 96577, Washington, DC 20090

REEBOK GIVES \$350,000 TO TRANSAFRICA ... In response to rumors they were doing business in South Africa, Reebok donated a staggering \$350,000 to TransAfrica, the radical pressure group that has voiced support of Marxist-Leninist guerrilla and terrorist groups and communist and radical one-party states from Grenada to Mozambique, as well as for the Cuban military presence in Angola. Think about that next time you're shopping for a pair of yuppie tennis runners. Reebok has a toll-free number (800-843-4444) in case you have an opinion you'd like to share.

HEROES ALL ... Last May visiting South African Nelson Mandela, head of the ANC (the one who got the tickertape parade and hero's welcome through New York), admitted that ANC members had been tortured to extract information and to penalize them for insufficient loyalty to the ANC hierarchy. Then last June in New York he publicly thanked Castro and Khadaffi for their support. The ANC is officially designated as a terrorist group by the U.S. government because of its continuing advocacy of (and practice of) violence against civilians, yet when its head comes to the United States he is greeted by the Congress and meets the president. George, you losing your grip, or what?

GIVE ME LIBERTY INFO ... Researcher seeks data, photos, anecdotes for book on Liberty-class merchant ships. Contact Adam Geibel, P.O. Box 59113, Philadelphia, PA 19105

FLAG BOOK ... Edwards Enterprises (Dept. SOF, 1014 14th St., #10, Santa Monica, CA 90403) is offering a 52-page reprint of the Congressional book *Our Flag* for \$4.50 postpaid. Covers history, customs, proper display, obtaining burial flags and much more.

INTERNATIONAL GUN RIGHTS ...

Being coordinated by National Firearms Association, Box 1779, Edmonton, Alberta, Canada T5J 2P1. They keep up with anti-gun fronts in Canada, Australia, New Zealand; drop them a line and see what's going on.

PEOPLE'S DAILY WORLD ... The Moscow-subsidized mouthpiece of the Communist Party, U.S.A., is showing signs of the dollar squeeze. Earlier this year they dropped to four issues a week from five, and a drive to get \$500,000 from readers fell on its face at \$143,688. At 5,000 CPUSA members, that would have been a hundred bucks a head — too strong a test of dedication. With Guss Hall and Gorby not getting along too well, the purse strings are tightening. Always seemed like a waste anyway, when they already have the networks and Time, Inc. to push their agenda for free and with more style. Well, don't worry, boys, maybe Ted Turner will buy you out.

CAR WARS: LIBYAN INVASION ...

Steve ("Chutzpah") Himelfarb of Washington, D.C. recently invaded the Libyan Embassy bent on Pillage and Rip. Pillaged parking lot at embassy (closed 1981 in retaliation for Libya's terrorist sponsorship), ripped off three parking spaces. Sunk his steel post opposite existing one, strung chain and padlock, securing permanent squatting rights. But permanent wasn't long when other squatters complained to United Arab Emirates Embassy — they attend to Libyan affairs — and Himelfarb had to remove his chain.

Not to feel bad, Steve. De Stockholm city council recently voted to *not* give de King of Sveden a special parking permit to facilitate His Mayesty's errand-running — said it would set a bad precedent and ewer'body might vant vun. But by Golly dat's just de vay it's been in the Monarch business ewer since de French Revolution. First dey von't let jou lop heads, den dey take away jour parking priwileyes.

MILITARY REUNION NEWS ... A publication of interest to those involved with reunions, available from *Military Reunion News*, Dept. SOF, Box 355, Bulverde, TX 78163. Six issues a year for \$15 ☒

COMBAT ZONE

Soar with us high over London where Spitfires and Messerschmitts clash in the skies.
Dive with us deep in the Atlantic where the hunt goes on for a real *Red October*.
Battle by battle, *The Military Book Club* lets you witness history as it's made.

Get in on all the action.
Clip the coupon and join us today!

Take any 4 for 98¢

with membership

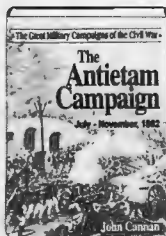

9522 \$9.95x



8318-9999* \$19.95x

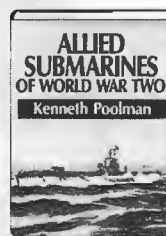

9472-9999* \$29.95



9605 \$19.95

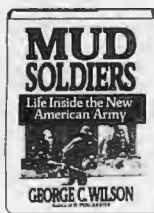

0125 \$19.95

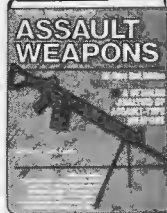

1073 \$14.95



9464 \$19.95



0760 \$21.95



9480++ \$19.95



1081 \$17.95



9498 \$24.95

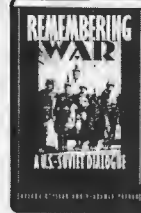

9514 \$27.95



5603 \$22.95

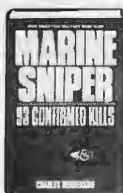

1289 \$18.95

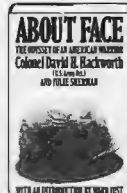

5504 \$24.95



1016 \$24.95



9506 \$19.95



9530++ \$18.95



1313+ \$12.95



4804 \$24.95



1396 \$24.95



1149 \$17.95



5728 \$24.95



0158 \$19.95

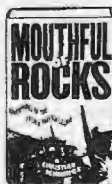

0729 \$18.95

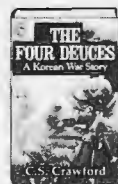

0703 \$18.95



1222++ \$18.95



0679 \$24.95



8292+ \$16.95



3988+ \$10.95



0315 \$49.50



3913 \$29.95



5520 \$19.95

HERE'S WHAT YOU GET WHEN YOU JOIN . . .

4 BOOKS FOR 98¢. Send no money now. You'll be billed 98¢, plus shipping and handling, when your membership is accepted.

A GUARANTEE OF SATISFACTION. If you're not 100% satisfied with your books, return them within 10 days at our expense. Your membership will be canceled and you'll owe nothing.

THE FREE CLUB MAGAZINE. You'll receive 14 issues a year. Each issue includes the Featured Selection(s) plus a number of Alternates from the Club's library of over 230 books. Twice a year, you may also receive offers of Special Selections.

SHOPPING MADE SIMPLE. To get the Featured Selection(s), do nothing—it will be sent automatically. If you prefer another book—or none at all—simply return your Member Reply Form by the date shown. A shipping and handling charge is added to each order.

AN EASY-TO-MEET OBLIGATION. Take up to 2 years to buy 4 more books at regular low Club prices. Afterwards, you may resign membership anytime. Or you may continue to enjoy the benefits of belonging to *The Military Book Club*.

HUGE DISCOUNTS . . . as much as 30% off publishers' hardcover editions. Club books are sometimes altered in size to fit special presses. All are printed on high-quality, acid-free paper.

RISK-FREE RETURN PRIVILEGES. If you get an unwanted book because your Club magazine came late and you had less than 10 days to decide, simply return the book at our expense.

PRICES SHOWN ARE FOR PUBLISHERS' EDITIONS.
CLUB HARDCOVER EDITIONS SAVE YOU UP TO 30%.

THE **MILITARY BOOK CLUB** ★★
Your #1 Source for Military Books

MAIL TO:
The Military Book Club
6550 East 30th Street
P.O. Box 6357
Indianapolis, IN
46206-6357

Please write book numbers here:

| | | | |
|--|--|--|--|
| | | | |
| | | | |
| | | | |
| | | | |

17564 09

If you select a book that counts as 2 choices, write the first 4 digits of the book number in one box and 9999 in the next.

YES! Please enroll me in *The Military Book Club* according to the risk-free membership plan described in this ad. Send me the 4 BOOKS I've indicated. Bill me just 98¢, plus shipping and handling.

Mr./Mrs. _____
Miss/Ms. _____ please print

Address _____ Apt. _____

City _____ State _____ Zip _____

Members accepted in U.S.A. and Canada only. Canadian members serviced from Canada, where offer is slightly different. Sales tax added where applicable. We reserve the right to reject any application.

SOF 10/90

WORLD SITREP



AFGHANISTAN: Soviets upping deliveries of weapons, fuel, food to Kabul, have increased number of military advisers; now \$340 — 400 million a month, up from \$300 million a month last year ... **ALGERIA:** teetering on the brink of becoming world's second Islamic Republic ... **BELGIUM:** former leader of Neo-Nazi VMO arrested on assault charge ... **BRAZIL:** promises no nukes from their secret enrichment plant at Aramar ... blowing up some 110 unauthorized jungle airstrips used by illegal gold miners and dope runners ... **BRUNEI:** creating separate air force, buying 16 Hawk aircraft; also buying three Vigilance missile corvettes from Brits ... **CHAD:** French send more troops, aircraft to eastern sector to help defend against Libyans, Muslim extremists ... **BURMA:** as usually happens when the commies actually hold an election, the heavies lost badly — will they turn over the reins? Time will tell ... opium warlord Khun Sa training Hmong rebels from Laos in camps near Thai border ... **CUBA:** new battery of nuke-capable SA-2 missiles near Havana, probably to protect radio-jamming equipment there ... **CZECHOSLOVAKIA:** Good Guys swept the elections (when will the commies learn not to hold elections) ... our favorite campaign buttons reproduced here — one says "If you don't vote, you vote for communism" The other says "You can take communism and stick it up yer butt" ... heh, heh —Czechs may get the hang of democracy pretty quick, heh, heh, heh ... **DDR:** East Germans now have golf association; unfortunately, no golf courses ... army stood at 173,000 last November, now about half that through desertions and discipline problems ... **EGYPT:** Egyptian Organization To Free The Homeland From The Zionist Stain threatened to torch Nile Hilton in Cairo ... **EL SALVADOR:** army officer and enlisted man on trial for murder of 10 people in San Vicente in 1988 ... **ETHIOPIA:** two Libyan diplomats expelled after bomb exploded in Addis Ababa Hilton, home of Israeli ambassador ... Israeli advisers taking place of departing Soviets ... **FINLAND:** man

hijacked Soviet airliner and then sought political asylum in Helsinki ... **FRG:** three IRA terrorists caught planting bomb at British military barracks, gunfire exchanged, no one hurt, Brits sent guard detail back to rifle range ... Bavarian police raided HQ of *Wehrsportgruppe Wolfsschanze*, glommed weapons, Nazi insignia, animal bones; two leaders under investigation for armed robbery ... **GREECE:** 10 diplomatic vehicles blown up by Social Resistance Group, who said it was protest against treatment of Third World countries ... **GREAT BRITAIN:** animal rights buffoons raided farm in Colby, freed 12,000 edible snails ... **GRE-NADA:** issuing postage stamp to commemorate 50th anniversary of U.S. Airborne ... **INDIA:** preparing for a punch-up with Pakistan over Kashmir; one to watch, as this could go nuclear ... **INDONESIA:** attacks on police posts in North Sumatra by separatist group *Aceh Merdeka* ... **IRAQ:** has launched 48-ton three-stage rocket capable of putting satellites in orbit; also test fired 2,000km surface-to-surface missile based on Argentine Condor, developed with Egyptian help ... **ISRAEL:** reserve Lt Col Yair Klein charged in Jerusalem court with illegally exporting military know-how; also wanted in Bogota for training cartel hitmen ... tunnels used by Palestinian activists discovered linking Gaza to Egypt ... **ITALY:** sent tech team from Turin to India to see why torpedoes they sold them tend to home on the launching ship ... convicted, paroled Red Brigade members caught near Swiss border with carload of arms ... **JAPAN:** third in world behind U.S. and USSR in military expenditures, now wants to purchase AWACS, MLRS, Aegis radar ... **LITHUANIA:** new Soviet commander is Gen. Vakentin Varenikov (planned invasion of Afghanistan, was senior commander in Kabul); his second in command is Gen. Igor Pavlovsky (in charge of Prague Spring, 1968) ... **MADAGASCAR:** three dead, 15 wounded in coup attempt where 11 rebels seized radio station, proclaimed new government ... **LEBANON:** rival Christian forces in howitzer/mortar punch-up across Christian enclave ...

MAURITANIA: United Front for Armed Resistance in Mauritania (UFARM) announced its formation, pledges to fight for Negro rights ... **NAMIBIA:** negotiating with PRC to acquire air-defense system ... **NICARAGUA:** 125,000 farmers given appropriated land under Sandinista government want to keep it ... Sandinistas passed out over 100,000 AKs to supporters after they lost the election ... mass grave discovered near military base at Wiwili, remains identified as youths, child captured by Sandinistas seven years ago ... **PERU:** 50 old folks and children killed by terrorists in Sonomoro, who then torched homes and school ... Senderista landmine killed seven police near Chosica ... **PHILIPPINES:** Brit counterterrorism experts helping train Aquino's palace guard ... **POLAND:** crimes up 80% in 1989 to more than 500,000 — nearly a third property crimes. Warsaw has 3,200 openings on police force but after 40 years of ham-handed commie cops nobody wants to be one ... **PERU:** power rationing in wake of concentrated Shining Path sabotage of electric net ... **PRC:** equipping its naval helicopters with Italian Whitehead-Sistomi A.244 anti-sub torpedoes ... Chinese Muslims in Xinjiang have declared holy war on Beijing, threaten to form Islamic Republic; Islamic Party of East Turkistan has formed "dare-to-die" squads, stockpiled large quantities of arms ... **ROMANIA:** many ambassadors boycotted inauguration of new maximum leader Iliescu in response to his Ceausescu-style handling of protestors ... **SOUTH AFRICA:** preparing to market their answer to the Apache/Augusta/Mi-26, the Rooivaalk attack helicopter ... arrests made in connection with theft of military weapons by anti-reform elements ... **SPAIN:** suspected Yugoslav gunrunner Haki Ceku avoided testifying in court by sewing his lips shut, pounding his attorney with an ash tray; attorney quit, judge gave Ceku

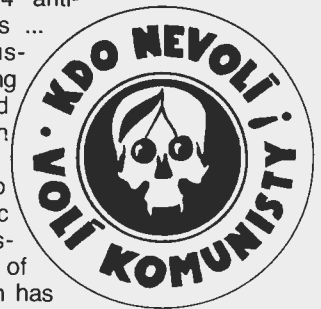

Continued on page 144

Strange advice from the authors:

BURN THIS BOOK

But that's only the beginning, if the peaceniks have their way and Russia ever does take over. The alternative might be to spend the rest of your days up near the Arctic Circle.

Say, what's going on here? Has the Conservative Book Club suddenly started offering kooky books?

Not on your life — and we use those words advisedly. This one is by Robert Conquest, who probably knows as much about the Soviets as any Westerner alive today. Conquest, now a senior research fellow at the Hoover Institution, wrote the classic study of Stalin's reign of murder, *The Great Terror*. Co-author Jon Manchip White is the Lindsay Young Professor of English at the University of Tennessee. So you'll be reading a serious book about a grim possibility. This isn't a 1984-style fantasy. *This book is based entirely upon what hundreds of millions have suffered when the Communists took over — but with ingenious variations added especially for America.*

When the Soviets Come

- How the Soviets "will establish their grip on the political organization of the U.S."
- The unlucky 20 percent: what awaits us. And for those *not* arrested, you're doomed to the daily grind, which Conquest and White spell out in detail.
- How particular people are likely to fare: professionals, liberals, ethnics, clergymen, dozens more.
- The inevitable Resistance Movement: long and short term prospects. How you might become a part of it. What methods will work best.

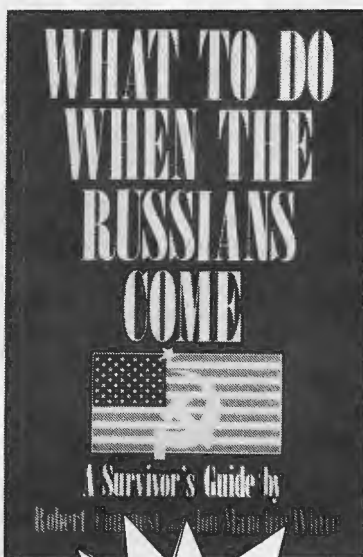

FREE
with Club
membership

Life in the New America

- ✓ Rationing, currency "reform," and other "economic adjustments" sure to come. Businesses that will close immediately. The lucky few that may thrive (so to speak).
- ✓ The chilling war-and-its-aftermath scenario "commonly found in Soviet military literature."
- ✓ When famine hits America: watch for these telltale signs beforehand.
- ✓ Major immediate problems, not excluding gang rape by the invading Russian troops (who will be called "peacekeepers").
- ✓ Raising kids under the new regime.
- ✓ From the official Soviet list of people subject to repression in the Baltic states, some lessons.
- ✓ What will happen to your house. Your car. Things you take for granted now that you'll drool over then.
- ✓ The New America: 7 characteristics.
- ✓ Where the resistance activity will start. What it will have to do first. How the Communists will counter the freedom fighters. Where to learn about guerrilla warfare, and about *surviving*.

It *could* happen. And if enough people scoff at the possibility, it *will* happen. Paradoxically, this book not only helps you prepare for the worst. It also helps it *not* to happen.

"A startling account of what to expect in the U.S. if we become so spineless that the Soviets take us over . . . If there is truly such a thing as must reading, *What to Do When the Russians Come* is that book."—*Wall Street Journal*

"Sober . . . hair-raising . . . makes scary sense. . . . Overdone? Scarcely. Anyone who knows the literature on the Czechs, Poles, East Germans, Ukrainians, Hungarians, Afghans, Vietnamese, and on the dissenters, resisters and refuseniks in the Soviet Union itself, will be impressed by the low key of the book."—Max Lerner, *New York Post*

How to get this \$14.95 book FREE

How the Club Works

Every 4 weeks (13 times a year) you get a free copy of the Club Bulletin which offers you the Featured Selection plus a good choice of Alternates — all of interest to conservatives. ★ If you want the Featured Selection, do nothing; it will come automatically. ★ If you don't want the Featured Selection, or you do want an Alternate, indicate your wishes on the handy card enclosed with your Bulletin and return it by the deadline date. ★ The majority of Club books will be offered at 20-50% discounts, plus a charge for shipping and handling. ★ As soon as you buy and pay for 3 books at regular Club prices, your membership may be ended at any time, either by you or by the Club. ★ If you ever receive a Featured Selection without having had 10 days to decide if you want it, you may return it at Club expense for full credit. ★ Good service. No computers! ★ The Club will offer regular Superbargains, mostly at 70-90% discounts plus shipping and handling. Superbargains do NOT count toward fulfilling your Club obligation but do enable you to buy fine books at giveaway prices. ★ Only one membership per household.

CONSERVATIVE BOOK CLUB

15 OAKLAND AVENUE • HARRISON, NY 10528

Please accept my membership in the Club and send FREE *What to Do When the Russians Come* by Robert Conquest & J. M. White. I agree to buy 3 additional books at regular Club prices over the next 18 months. I also agree to the Club rules spelled out in this coupon.

SOF-8

Name _____

Address _____

City _____ State _____ Zip _____



Items on Left (Clockwise from left.)

- #7033 SOF Magazine Binder. Sturdy black binder keeps your issues protected and handy. Holds 12 issues. **\$10.95**
- #5007 Urban Recon 6-pack carrier, grey. This insulated pack keeps beverages cold. (Not for use with ice.) **\$10.95**
- #7090 SOF Can Wrap, black with white logo. **\$4.95**
- #7070 SOF Coffee Mug, white with red logo. **\$6.95**
- #7050 SOF Luggage Tag, white with black logo. **\$4.95**
- #7110 SOF Ashtray, white with red logo. **\$4.95**
- #7120 Stein. 12-oz., clear with red logo. **\$7.50**
- #7100 Shot Glass. 4-oz., clear with red logo. **\$4.95**
- #7130 SOF Leather Coasters. Set of 4 with logo. **\$5.95**



Patches (From left to right)

- #7003 Shield Patch. **\$4.95**
- #7002 SOF Round Patch, OD. **\$2.95**
- #7001 SOF Round Patch, red. **\$2.95**
- #7060 SOF Patch, black. **\$4.95**

Badges (By vertical rows, from left)

- #7005 SOF Key Ring. **\$5.25**
- #7024 Beret Badge, black. **\$8.00**
- #7023 Beret Badge, silver. **\$8.00**
- #7021 SOF Lapel Pin, silver. **\$5.95**
- #7043 SOF Lapel Pin, gold. **\$5.95**
- #7020 SOF Lapel Pin, red. **\$3.95**
- #7022 Beret Badge, red. **\$7.00**
- #7053 Death to Tyrants Badge. **\$5.95**



Items on Right (Clockwise from left.)

- #2004 Black SOF Ball Cap with scrambled eggs. Col. Brown's favorite. **\$10.95**
- #2001 Maroon Beret. Sizes 6 1/2 - 7 3/4. (Beret badge not included.) **\$14.95**
- #2010 Khaki Field Cap. Lined. S,M. **\$22.95**
- (#2011 Unlined Field Cap. S,L,XL. **\$12.00**)
- #2021 SOF Ball Cap with Oak Leaf Cluster. Distinctive, brilliant white. **\$9.95**
- #7014 Web Belt, black. (No Buckle.) **\$3.50**
- #7012 SOF Silver Military Buckle. **\$11.95**
- #7013 SOF Black Military Buckle. **\$11.95**
- #2020 SOF Oak Cluster Cap, grey. **\$9.95**
- #5005 SOF Duffle Bag. Large size. Black, sturdy rip-stop nylon for hard wear. **\$29.95**

Items Below (Clockwise from left.)

- #7051 SOF Navy Blue tie. Oh, so subtle way of letting your presence be known. **\$15.95**
- #7200 SOF Mirrored Sunglasses. **\$9.95**
- #7140 SOF Money Clip. **\$5.95**
- #7045 SOF Zippo lighter. For those who value never-fail dependability. OD. **\$16.95**
- #7006 Ranger knife. 4 in. blade, 9 inches overall. Grooved grip. Black with bronze SOF logo. An impressive instrument. **\$39.95**
- #7161 SOF Watch. Red logo and black, waterproof band. 1-year warranty. **\$29.95**

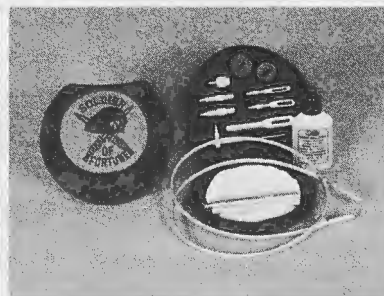

Item Above

- #5008 Otis Gun Cleaning Kit. A gun's best friend in the field holds cleaning rod, brass-slotted tips and "T" handles, patches, solvent, instructions. All in a pocket-size case with OD SOF logo. **\$29.95**

Items Below (From left.)

- #5010 SOF Fanny Pack. Roomy pack frees your hands for important activities. Durable black nylon with SOF logo. **\$24.95**
- #5009 Omega Group Waist Pack. Convenient size when you want to travel light. Black nylon with white Omega logo. **\$14.95**



When the world is your backyard, you need gear you can trust.

At the SOF Exchange, we know you want equipment you can count on. Whether your adventures take you to the Orient or Ohio, Chile or Chicago, Guyana or the gym, our tough gear won't fail you. Order now!



SOF EXCHANGE
P.O. Box 687 DEPT 10-90
Boulder, CO 80306 USA
Call Toll-Free: Mastercard, VISA or COD
orders: 1-800-323-1776, Operator 131.
For FAX orders: (303) 444-5617. Customer Service: (303) 449-3750.

PAYMENT: VISA/MC CHECK COD
CARD # _____
EXP. DATE _____
NAME _____
ADDRESS _____
CITY _____ STATE _____ ZIP _____

| QTY. | ITEM NO. | SIZE | PRICE |
|----------------------------------|----------|------|-------|
| | | | |
| | | | |
| | | | |
| | | | |
| SUB TOTAL | | | |
| P&H | | | |
| 3.7% Sales Tax (Colo. Residents) | | | |
| TOTAL | | | |

T-Shirt sizes S, M, L, XL. \$1.00 extra for XXL.
Add \$3.00 for first item ordered plus \$1.00 per each additional item for postage and handling. Overseas orders add 40%. Allow 4-6 weeks for delivery.

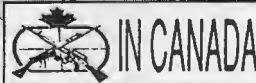

MILARM CO. LTD. 10769 - 99 ST.
EDMONTON, ALBERTA T5H 4H6
PHONE 403-424-5282 FAX 403-424-5306

Photo Gary Cook

FULL AUTO

by Peter G. Kokalis

Flechette Fantasies

APPARENTLY

miffed at criticism leveled against flechette ammunition (fired in the Steyr and AAI Advanced Combat Rifle (ACR) entries) by SOF (see "21st Century Combat Rifle," October '89), and others, Picatinny Arsenal has issued a "Fact Sheet" on "Flechette Lethality and Effectiveness" that is sadly short on facts.

The press release states in part that, "There is a significant amount of data on the lethality or wounding potential of high performance rifle flechettes. This data includes an extensive amount of simulated and animal tissue firings in the mid-1960s under the special purpose individual weapon program. Gelatin firing tests in March 1988 at the Ballistic Research Labs (BRL) at Aberdeen Proving Ground, Maryland, re-validated the existing data base ... Their effectiveness compares favorably to bullets striking at ranges to 500 meters or more." William T. Harris III, a spokesman for Picatinny, comparing flechettes with the M16 round has further stated, "We consider the impact equal." No matter how you slice it, this is pure baloney.

In October 1966, Mr. Robert E. Roy, then the Engineering Project Manager for Colt's Inc., reported the following to his superiors after witnessing a SPIW (Special Purpose Individual Weapon) demonstration at Fort Benning, "The flechette does not always tumble, however, and this has been a source of embarrassment to the supporters ... If the flechette does not tumble, it has

little stopping power and a person might hardly know he is shot ..."

It was this same "data base" that supported the seriously flawed Relative Incapacitation Index. Most wound ballistics authorities now acknowledge that so-called "kinetic energy deposit" does not equal "stopping power" or "incapacitation" (see "Killing Effect," December '88, and "Killing Effect II," January '89). Yet BRL continues to measure effectiveness by measuring the kinetic energy lost from the projectile and assumed to be deposited in the target. They totally ignore that fraction of energy converted to heat. They incorrectly equate the wounding effects of temporary and permanent cavitation. They use a gelatin formulation (20 percent) that overstates the wounding potential by as much as 45 percent. When flechettes do bend (after they strike bone, which is only about 25 percent of the time) the diameter of their wound track is still only half that of the projectile's original length (1 1/8 inches)

Although its compact envelope is appealing to special ops units, the CAR15 and its current variant, the Colt Commando, compromise the lethality of M193/M855 projectiles and drop effective performance against human targets to no more than 100 yards.

and the temporary cavity produced is insignificant, unless a nonelastic organ such as the liver or brain is hit.

Even if we play their kinetic energy game, the results are less than impressive and BRL is merely hoisted on its own petard. If, in fact, the AAI flechette does reach a muzzle velocity of 4,600 fps as claimed, these 10.2-grain flechettes have only about 480 ft-lb of energy — only 39 percent that of the 56-grain M193 M16 projectile. Downrange, when traveling at 3,281 fps (1,000 mps), we're left with only 244 ft-lb — less than that of a .38 Special handgun bullet.

The FBI parted company with this false "data base" after the lightweight, high-velocity Winchester 9mm Silvertip bullet failed them during the now infamous Miami shootout and two agents were lost. Exaggerations and outright falsifications to support defective concepts degrade the entire science of wound ballistics and raise serious concerns about the entire \$57 million ACR boondoggle.

I might add that FN's new caliber 5.7x28mm P90 personal weapon features a bullet whose wounding capacity is based upon the same misconceptions (a highly exaggerated expectation from a baseball-sized temporary cavity) as the ACR flechettes. Unfortunately for the users, the engineers who design



AAI Corporation's Advanced Combat rifle fires a 10.2-grain flechette with a claimed muzzle velocity of 4,600 fps.

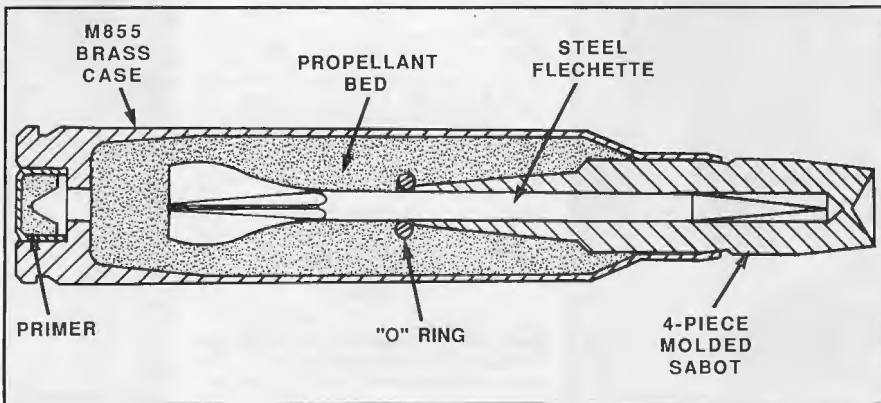

Lest We Forget

THE VIETNAM WAR .45

Firing, custom built, 24-Karat Gold plated limited edition of only 2,500 in honor of the retirement of the famous M1911A1 .45 and the man who made it famous in its last year.



Limited Edition: 2,500
Plating: 24-Karat Gold
Caliber: .45 ACP



"No one could have done it better."

General William C. Westmoreland in praise of our troops who served in Vietnam.

Since 1911, America's fighting men have defended our freedom with this, the most powerful military-issued sidearm in world history. But after 75 years of faithful service, it has been replaced by the smaller 9mm handgun, to standardize ammunition throughout the NATO nations.

Now, The American Historical Foundation is proud to salute this renowned military sidearm and the men who made it famous in the last war ever to be fought with the M1911A1 .45 through the issuance of the Vietnam War Commemorative .45.

An American military tradition is passing into history. But the M1911A1 .45 and the Americans who carried it must not be forgotten.

24-Karat Gold Plating

This hand built .45 features significant coverage of 24-Karat Gold plating for lasting value and museum-quality beauty. Deeply etched along the slide and plated with 24-Karat Gold are historical inscriptions framed in a bamboo-patterned border. Dragons—the Asian symbol of power and protection—guard the panopoly. Ten components—the trigger, hammer, slide stop, magazine catch, magazine catch lock, safety lock, and grip screws—are plated with 24-Karat Gold.

The grips are specially hand-finished to look like golden bamboo, but they are actually custom-crafted American Oak. Made by the respected firm of Herrett's, each grip is inset with a full-color, fired-enamel cloisonne medallion of the Vietnam War Service Medal.

Limited Edition; Fires .45 ACP

This is a strictly limited edition of only 2,500, your guarantee of rarity and value. Each pistol in the edition is serially numbered from 0001 to 2500 with the prefix VN for Vietnam.

A Certificate of Authenticity attesting to the edition limit and the purity of the 24-Karat Gold

plating is also provided with your M1911A1 .45.

Each is being custom built to military specifications—but to presentation quality—by Auto-Ordinance Corporation, the company founded by General John T. Thompson, who helped develop the .45 pistol. NRA test firing of their .45 shows accuracy "significantly better than the average as-issued M1911." All parts are interchangeable with military-issued pistols. It fires .45 ACP ammo readily available at your local gunshop. And because it is a firing .45, it could be used in the defense of your home or family.

Satisfaction Guaranteed

The Vietnam War .45 is available exclusively from The American Historical Foundation. To reserve, call our Member Services staff toll free, write or visit our historic Headquarters and Museum, "Columbia," a National Historic Landmark built in 1817. Your satisfaction is guaranteed or you may return it within 30 days for a full refund. With



The optional furniture-grade American Walnut Display Case, lined in jungle green velvet, allows you to display your .45 on a wall, shelf or desk. The locking glass lid protects your investment from dust and unauthorized handling. 14" x 8" x 3".

your reservation you will be made a Member of the Foundation.

If you do not have a Federal Firearms License, we will coordinate delivery to you through your local firearms dealer after your reservation is received here. If you have an FFL, send a signed copy with your reservation.

Honor the 75 years of service of the powerful .45 and the men who helped make it famous by proudly owning and displaying this museum-quality firearm.



Personalized engraving available on right side of slide.

RESERVATION

Please respond by 31 October 1990

Satisfaction Guaranteed or Return in 30 Days for Full Refund

To: The American Historical Foundation
1142 West Grace Street, Dept. H237
Richmond, Virginia 23220
Telephone: (804) 353-1812
TOLL FREE: (800) 368-8080



Yes, I wish to reserve the firing, limited edition, Vietnam War Commemorative .45 selectively plated with 24-Karat Gold. I will also receive a Certificate of Authenticity and membership in the Foundation. Satisfaction Guaranteed.

- My deposit (or credit card authorization) of \$95 is enclosed. Please charge or invoice the balance due...
 - in five equal monthly payments of \$200. in full.
- Please also send the optional Walnut Display Case adding \$119 to the final payment selected.
- My payment in full is enclosed (\$1095 per gun; Display Case add \$119).
- Please personalize my Pistol, at \$29; please send the Engraving Request Form.

Name

Address

Daytime Telephone (.....)

For Visa, MasterCard or American Express, please send account number, expiration date and signature. Virginia residents add 4.5% tax.



Higher TEC.

At two-thirds the weight (and price) of an Uzi, the TEC 9 series clearly stands out among high capacity 9mm assault-type pistols.

Once for ounce they deliver more gutsy performance and reliability than ANY other gun on the market.

TEC-9's are built tough for rugged weather and terrain. And they're built comfortable with an ergonomically designed grip and frame - 32 rounds of firepower make them ideal for self-defense or recreation. Simple, two-step disassembly for easy cleaning makes them convenient.

In Standard or Mini version, blued, stainless steel, or our new "TEC-KOTE"

"... (Intratec) makes a gun that doesn't cost an arm and a leg, yet functions with impeccable reliability."

—Jerry Ahern,
Petersen's Handguns

finish, the TEC-9's offer rugged, reliable, affordable technology.

Higher TEC.

See the TEC-9 Series at your dealer today.



*Try our "HOT" TEC-22. Also available in Tec-Kote. For more information write to:

INTRATEC
FIREARMS

12405 S.W. 130th St. • Miami, Florida 33186

these whiz bangs have no knowledge of trauma medicine, can think only in terms of kinetic energy and will never be forced to personally demonstrate the merit of their devices on the field of battle.

Short-Barreled M16s

All those who are fond of the CAR15, Colt M16 Carbine and Commando models, should take note of the reduced wound ballistics potential of these short-barreled weapons at ranges beyond 100 yards.

The large permanent cavity produced by the 55-grain boat-tailed M193 bullet is primarily a consequence of fragmentation. As long as this FMJ bullet travels point forward, its wound track remains small and there is little tissue damage. However, after slightly more than 4 inches of penetration in soft tissue, the M193 projectile will yaw to 90 degrees, flatten and break apart at the cannelure (crimping groove). The bullet point remains as a flattened triangular section, retaining about 60 percent of the original bullet weight and penetrating about 13 inches in soft tissue.

That portion to the rear of the cannelure breaks into numerous fragments that penetrate up to 3 inches radially away from the main wound track. These multiple fragments perforate and weaken tissue. Tissue between two perforations is often completely detached when subsequently subjected to the sudden stretch of temporary cavitation. Weakened tissue may be split by stretch that would otherwise be absorbed by the tissue's elasticity.

There is a direct correlation between the bullet's velocity and the fragmentation pattern. When fired from an M16 rifle with a 20-inch barrel at a range of 100 yards, the M193 projectile generally breaks into two large fragments. At ranges of more than 200 yards, the bullet flattens somewhat and only a few small fragments squeeze out of the base. When fired from the 10.5-inch barrel of a Colt Commando the muzzle velocity drops from about 3,500 fps to only 2,650 fps. For each loss of 350 fps in velocity you must subtract approximately 100 yards from the distance at which significant fragmentation will cease.

In other words, as far as the wound ballistics potential is concerned, these short-barreled M16s cannot be trusted to provide effective lethality at ranges beyond 100 yards. You can expect approximately the same results from the M16A2's new M855 (SS 109) ammunition. If you are in an environment where you can anticipate contact at ranges greater than 100 yards, then I'd hump down to the supply room and trade that shorty for a full-length rifle. ☒

ROLLING BACK PRICES TO 1982 AND BEYOND

~~\$2750.00~~
\$1695.00

\$100 extra for weapon mounts

STANO AN/PVS-2 NIGHT VISION SIGHT



Features: 25mm 1st Gen. Image Intensifier • Med-Range Starlight System • Infrared Light Detection • High Luminous Gain
Includes: Daylight Cover • Pistol Grip • Manual • AAA Battery Adapter

STANO AN/PVS-4 MODULAR NIGHT VISION SYSTEM



Features: 25mm Second Gen. Intensifier • Flash Protection, ABC, & Manual Gain Control • 4x Optical Syst. • Detachable Eyepiece
Includes: Daylight Cover • Securing Knob • 'AA' Battery Adapter • Cleaning Kit • Carrying Bag • Storage Case • Manual

New with Reconditioned Intensifier
\$2850.00

Surveillance Target Acquisition Night Observation COMPONENTS

FINANCING AVAILABLE

P.O. Box 2048 • Carson City, NV 89702

NOT SOLD FOR EXPORT

(702) 246-5281 (702) 246-5283 FAX (702) 246-5211

Send \$4.00 for comprehensive Catalog of our STANO Devices

THE WORLD'S "BEST KNIFE MAKER" CREATES

A VIKING MASTERPIECE.

WROUGHT OF TEMPERED STEEL. 24 KARAT GOLD.
STERLING SILVER. HAND-SET CRYSTAL CABOCHONS.

Sid Birt, acknowledged the world's best knife maker and winner of the prestigious Beretta Award, captures the bold, adventurous spirit of the ancient Norsemen.

Experience the power of THE VIKING KNIFE. A supreme work of Viking art. Wrought of tempered steel. Ablaze with gold and silver electroplate.

The sculptured pommel portrays the Viking dragon. The grip is elegantly crafted of simulated ivory and richly lavished with authentic Viking ornamentation. The serpentine designs on the blade guard are reminiscent of the Jellinge style.

To preserve and protect your imported Viking Knife, the locking hardwood and glass presentation case is included at no additional charge.

Only from The Franklin Mint. The price, \$395, payable in monthly installments.

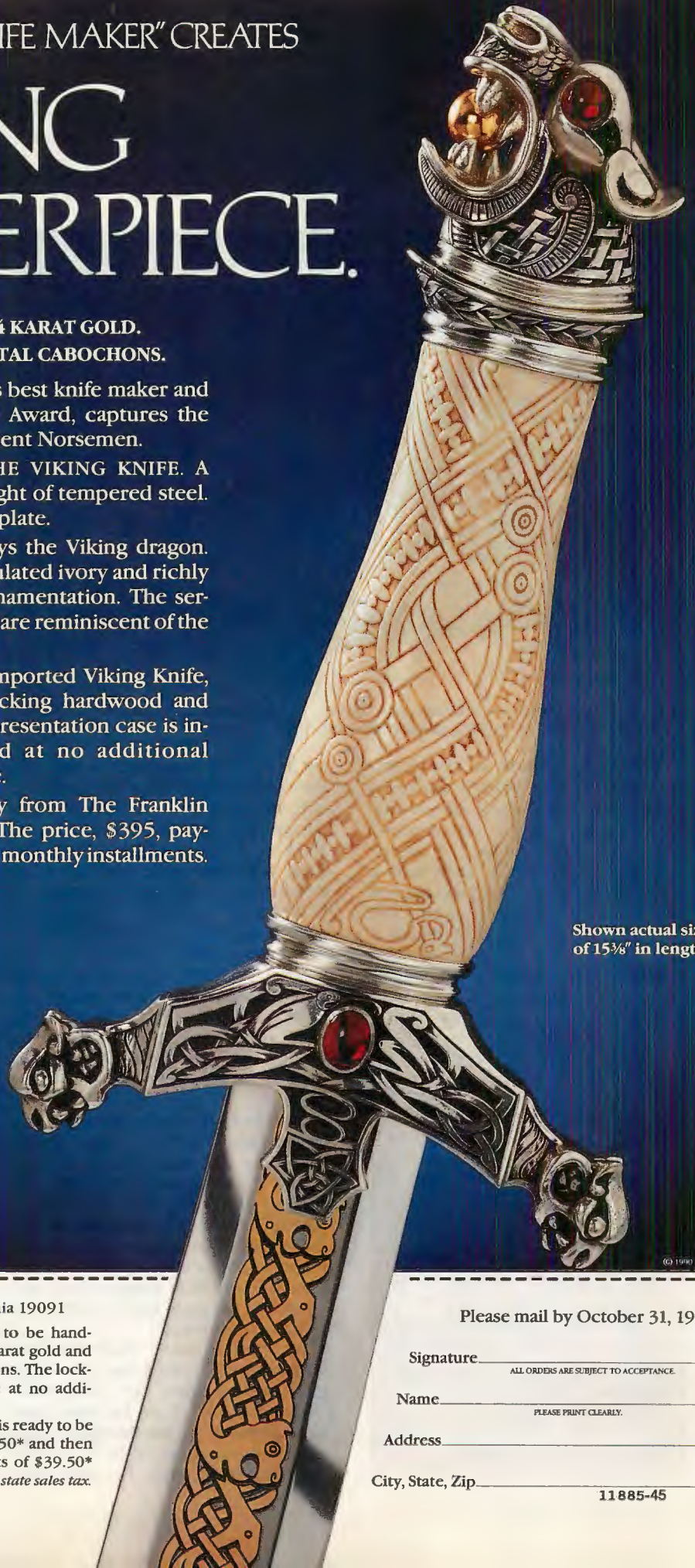

Shown actual size
of 15 3/8" in length.

© 1990 FM

The Franklin Mint Franklin Center, Pennsylvania 19091

Please enter my order for THE VIKING KNIFE, to be hand-crafted of tempered steel, electroplated in 24 karat gold and sterling silver and hand-set with crystal cabochons. The locking glass and hardwood display comes to me at no additional charge.

I need send no payment now. When my knife is ready to be sent to me, I will be billed for a deposit of \$39.50* and then for the balance in 9 equal monthly installments of \$39.50* each, after shipment.

*Plus my state sales tax.

Please mail by October 31, 1990.

Signature _____

ALL ORDERS ARE SUBJECT TO ACCEPTANCE.

Name _____

PLEASE PRINT CLEARLY.

Address _____

City, State, Zip _____

11885-45

I WAS THERE

by Tim Arnold

Camperland



Photo copyright Alex Ethridge

Proud graduates from Camper's Mercenary Training School: Operation Golden Temple Class. SOF chose to grant both pupils and weapons anonymity.

SOF is no admirer of ersatz boot camps like Frank Camper's mercenary school. Still, every week we get calls from folks who want to attend one of these merc junior colleges. In light of this fact, we thought it appropriate to share Mr. Arnold's first-person account of life masquerading as a modern day mercenary in the woods of Alabama: War is heck.

I MET Frank Camper when I started

CAMPER INCARCERATED

Frank Camper went to California, apparently to work on a film project, in 1986 and was soon linked to an incident involving the firebombing of several (empty) cars. The owners of these cars were reportedly harassing ladies that Camper had befriended.

Details of the incident are extremely muddled and near as we can tell it comes down to which one of the involved parties you want to believe. After all was said and done two of the involved Camperland graduates were sentenced to probation, another given a five year prison term, and Frank Camper received 14 years.

out as a private investigator in my home town of Birmingham, Alabama, working skip traces for area bail bondsmen to supplement my income. In the fall of 1984, my partner Andy and I were told to go to a place called "the bunker" to look for an F.T.A. (failure to appear).

When we arrived at the address, nothing seemed out of the ordinary. The building was an older, one-story building front with a church in the left side, a dentist's office in the center, and on the right was a door with no nameplate and foil covering the windows.

"This has to be the place," I said to Andy as we approached the door of the office.

When we entered the building it was like stepping into the "Twilight Zone." The room was filled with displays of military paraphernalia. One wall was covered with every type of automatic weapon conceivable, including what I recognized to be a Soviet RPG (rocket propelled grenade launcher) — a high-tech, hard to obtain weapon. Andy and I stared at the room and its contents in childlike amazement.

"Can I help you?" inquired a firm voice. I turned to see a man of average build, well groomed and polite, obviously not the F.T.A. we had been sent to apprehend. I gave the skip trace's name but was careful not to say why we were looking for him. The man intro-

duced himself as Frank Camper, and quietly explained that the person we were looking for had indeed been a student at his mercenary school but had already left the state.

We relaxed and decided to use the opportunity to find out more about the mercenary school. A military buff since childhood, I was like a kid in a candy store. Frank took us into a side room covered with maps and introduced us to two of his instructors, Rusty and Paul. Rusty was an ex-Marine and very impressive, articulate, well mannered and in great physical shape. By contrast, Paul was not very impressive — slumped down in a chair, puny and hollow-chested, he had a languid, sloppy air about him. Something about him bothered me, but I couldn't put my finger on it. As we talked about the school, I began to take interest, and suddenly I knew it was something I had to do. I would have to arrange two consecutive weeks off from work, but I felt deep down it was a worthwhile venture.

A new school was starting in November 1984, code-named "Operation Golden Temple." When I arrived back at the bunker in camouflage fatigues to begin the school, I was mentally ready, but all my life I have had a serious weight problem. Never had it hindered me physically like it did in mercenary school. The first few days were murder, and we averaged only two hours sleep

Here's a photo that took balls: Author Tim Arnold being kicked during boot-to-crotch combat training. One nagging question — did he make the camp choir?

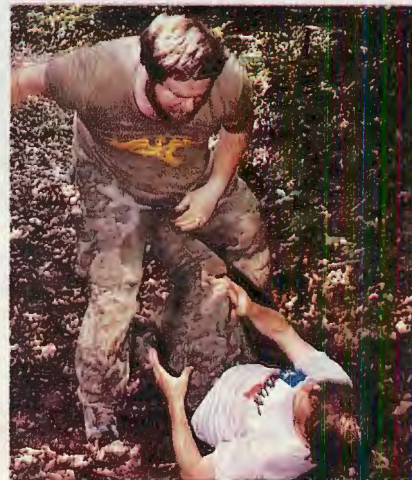
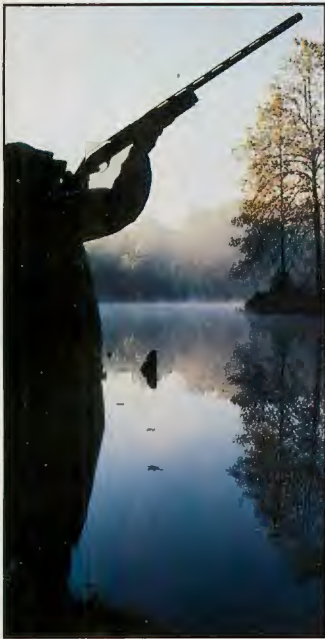

Photo copyright Alex Ethridge



The complete line-up.

Benelli M1 Super 90 A defensive firearm, a utility shotgun, or a dependable sporting arm, all describe the M1 Super 90. The Benelli inertia recoil operating system means fast-firing, reliable function with all types of 12 gauge shells, from light 2 3/4 inch field loads to the most potent 3 inch magnums. Special ghost ring sights are now options on the M1 SLUG and DEFENSE models. The M1 Super 90 FIELD model unites the quick handling M1 receiver and tough polymer stock with a wide choice of sporting barrels. A complete set of screw-in chokes gives the M1 FIELD unmatched versatility for hunting under the toughest conditions imaginable.

The **Benelli Black Eagle** is a premium grade sporting shotgun that combines the advanced technology of the M1 and Montefeltro Super 90 system with the classic design of vintage Benelli shotguns. The special two piece receiver of steel and aluminum means unmatched strength and enhanced balance. A distinctive high gloss walnut stock and gold plated trigger round out the fine lines of this select class shotgun. Black Eagles come in a variety of barrel lengths with a complete set of tough screw-in chokes. A new Black Eagle SLUG gun is now available with a 24 inch rifled barrel and scope mounting base on the receiver top cover.

Benelli Montefeltro Super 90 A direct descendent of the M1, the Montefeltro uses the same simple and reliable operating system. There is no complicated gas system to collect grime and powder residues. No complex linkages or pistons to clean or maintain. Like all Benelli shotguns, the Montefeltro disassembles completely without tools for easy cleaning and maintenance. The unique Benelli loading system lets you change a shell in the chamber without emptying the entire magazine. Something you'll appreciate if you need to change loads or want to safely unload the chamber. With the special buttstock adjustment kit the Montefeltro and Black Eagle shotguns can be easily custom-fitted to any shooter.

The **Benelli M3 Super 90 Combination Pump/Auto** joins the unique features of semi-automatic Benelli shotguns with a traditional pump action favored by many law enforcement agencies. Rugged, reliable, and easy to operate, the M3 can be quickly converted from auto-loading to pump by flipping a single spring-loaded ring in the forearm. The M3 functions with all standard shotgun loads as well as gas grenades, flares, and rubber ammunition. Designed to operate under the most demanding conditions, the M3 is now available with a tough folding stock and special ghost ring sights for fast target acquisition.

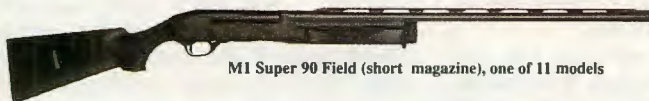

M1 Super 90 Field (short magazine), one of 11 models



Black Eagle with 26" barrel, one of 5 models



Montefeltro Super 90 Standard Hunter, one of 7 models



M3 Super 90 Combination Pump/Auto, one of 4 models

Advanced semi-automatic shotguns for sporting, law enforcement, and defense use. Available only at your Authorized HK Dealer, for the location nearest you call (703) 450-1900.



In a world of compromise, some don't.

per night for the entire two weeks. You never woke up naturally, it was always with explosions or tear gas, and you had to be the one to decide when it was safe to try to sleep. Falling asleep at the wrong time carried grave consequences, like being captured and tortured — really tortured. Everything was for real: the tear gas you ate all day long, the hand-to-hand combat, even the pellets in the sniper rifles of the cadre.

The first week consisted of combat training, reconnaissance, demolitions, weapons familiarization and prisoner handling. The second week was completely different. We were stripped down to our underpants, left barefoot, then forced into the woods without food or weapons. The cadre was instructed to hunt us like animals and if we were caught, to torture us until we escaped.

None of us knew when we were supposed to come back to camp, so every day we had to get close enough to see if the yellow "return" flag had been put out. One day as I scouted the base camp, I was discovered by a cadre patrol. I tried to run but was quickly surrounded and captured. I was taken back to "Switzerland," the base camp, and placed spread-eagle between two trees a full 2 feet off the ground. During the next two hours, I was poked and beaten with sticks and forced to watch the cadre eat up my rations. It had been days since I had eaten anything.

I kept thinking about what Frank had said: "You only fail if you stay captured." So I kept looking for a way to escape. Finally, one of the cadre noticed my hands and feet were going blue from lack of circulation and ordered the ropes to be untied for a short while. When they lowered my ex-

Camperland's version of pugil sticks or some arcane praying mantis religious ritual? You decide. We suspect this is the way these guys relax.



Photo copyright Alex Ethridge



Photo copyright Alex Ethridge

Who said you have to take your clothes off to practice sado-masochism. Obviously they hadn't done a tour at Camperland.

hausted body to the ground, I somehow found new energy and sprang to life, kicking one of the cadre in the chest, and running off the embankment into the creek and woods beyond.

I finished the rest of the school without any problems and graduated with honors (from Operation Golden Temple) as a team leader. Frank had given the school its name because four of the 20-man class were Indian religious extremists — Sikhs. At first they had seemed out of place, but they worked hard and began to fit in. They possessed a determined fighting spirit and doggedly kept singling me out to fight because of my large size. Two of them, Lal and Suki, were on my team. Suki spoke the best English and soon became a good friend.

Several months after graduation, Paul showed up at my house in western Birmingham. It was a routine visit except for his guests. I didn't know the two dark men I saw through the car windows, but when they got out I recognized one of them as Suki. The other was a bearded Sikh I had never met. A wary feeling crept over me.

As Paul walked with me into the house, he began to explain. It seems he and Frank were working with the U.S. government to set up and arrest the two Sikhs for terrorist activities against the Indian government. I told Paul I did not want anything to do with it — I was newly married and not looking for trouble. Also, Suki was my friend. But Paul persuaded me to cooperate by telling me the Sikhs were willing to kill innocent women and children just so they could take out Hindus in the process.

I asked Paul why he was bringing them to me. He said they were going to New Orleans for a hit on a visiting Hindu dignitary and the Sikhs were looking for any weapons they could get. Paul suggested we sell them my .45 and note the serial number so Frank could turn it over to the FBI first. I agreed, and the plan worked like a charm — the Sikhs were arrested in New Orleans. But there was one little hitch. Paul didn't tell Frank that I was in on the deal. He painted me as a co-conspirator instead. The next morning, before breakfast, I was roused out of my bed by Federal agents and taken, half-dressed, from my house and hauled downtown for questioning.

Once we arrived at the Federal Building, they began to interrogate me. I requested to speak with either Frank Camper or my attorney. At first my request was ignored and I was warned I might not have any chips to deal with if I didn't cooperate. Finally I was allowed to call my lawyer, who advised me not to say anything, just wait to see if I was charged. I was never charged in the matter and cooperated with the Justice Department in the prosecution of the Sikh terrorists, who eventually pled guilty in New Orleans.

I attended another of Frank Camper's schools in 1986, just before he was busted (see sidebar), and became a member of his mercenary association. Since then I have stayed out of trouble and have a good job as a supervisor. I often think about "the bunker" and my comrades in Operation Golden Temple — it was a great learning experience and I often wonder how much it changed my life. ✕



Turn *Your* SKS Into A

THRILLING ACTION WEAPON

**With Folding Stock
From The
Combat Exchange!**



Your ordinary SKS



becomes sheer excitement



with this folding stock.

- Fits any SKS
- Makes SKS stock 2" longer
- Stabilizes rifle, lessens recoil
- Lifetime guarantee
- Triples SKS value
- Enhances SKS overall appearance
- Makes you ready for "real action"
- Cleaning gear fits in pistol grip

COMBAT EXCHANGE

P.O. Box 1596 · Burgaw, N.C. 28425
(919) 259-7300

Call for your closest dealer

ATTENTION LAW ENFORCEMENT OFFICERS:

A LIMITED NUMBER OF STEYR AUG SEMI-AUTOMATIC RIFLES ARE NOW AVAILABLE FOR PRIVATE OWNERSHIP.



The Federal Government has released a limited quantity of Steyr AUG-SA semi-automatic rifles for sale to law enforcement officers only. These are rifles that G.S.I. had permits for prior to the semi-automatic rifle ban and will be the last available for private ownership.

The Steyr AUG-SA is world-renowned as the premier, semi-automatic rifle, and is now available for immediate delivery to federal, state, county and local law enforcement officers. To obtain one, an officer must have three documents completed:

- (1) A purchase order typed on an official department letterhead.
- (2) Certification by an officer's supervisor that the purchase is being made for personal use in the officer's duties.
- (3) Certification by the officer purchasing the rifle that the rifle is for personal use in the officer's duties. All documents must appear on department letterhead.

The price for the AUG-SA is \$1,375.00 plus \$5.00 shipping and handling, which includes the standard AUG-SA with green stock, 20" barrel, internal 1.5X optic, one thirty-round magazine, sling, cleaning kit and operator's manual. Special receivers, left hand bolts, 16 and 24" barrels and 30 and 42-round magazines can also be purchased from G.S.I.

ORDER YOUR STEYR AUG-SA TODAY AS QUANTITIES ARE LIMITED.

\$1375⁰⁰ COMPLETE

Officers wishing to purchase an AUG-SA can receive a special packet, which covers the documentation procedure from G.S.I. The packet can be obtained by writing G.S.I. at P.O. Box 129, Trussville, AL 35173 or by calling one of these numbers: (205) 655-8299 or 1-800-821-3021.

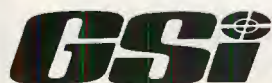

STEYR DIVISION OF GSI, P.O. BOX 129, TRUSSVILLE, AL 35173



TUNNEL RAT READER ... I thought you might be interested in knowing something about the photograph which appears in your subscription advertisement on page 82 of the May 1990 issue of *Soldier of Fortune*. The Marine emerging from the tunnel is me. It was taken while I was a battalion scout (S-2) with the 2nd Bn, 26th Marines, during operation Bold Mariner, January 1969. Bold Mariner took place on the Batangan Peninsula, south of Chu Lai, and was the largest amphibious operation of the Vietnam war to date.

Numerous tunnel complexes were found during the operation, some several hundred meters in length. I and other "tunnel rats" spent a great deal of time underground.

As I exited one of these complexes, Marine Corps combat correspondent SSG Bob Jordan took the above mentioned picture, and it has appeared in numerous publications over the past 20 years. And every time I look at it, it brings back some vivid memories.

I thoroughly enjoy your magazine. Keep it up.

Sincerely,
Glenn Cox
Batalusa, Louisiana

ANNIVERSARY KUDOS ... It hardly seems like 15 years have passed since I read my first-edition copy of *Soldier of Fortune* Magazine. Shortly after that, you and I met and formed a great friendship.

SOF Magazine has made tremendous progress in its 15 year history. It is now recognized as a polished, professional source of important international military and political information. From personal experience, I know that it is widely accepted in the highest levels of government and the Pentagon. *SOF* Magazine fills an important need in global affairs.

Bob, I urge you to tell your readers that, despite the positive changes occurring in the Soviet bloc, we must not "beat our swords into plowshares." The price of liberty is eternal vigilance.

Best wishes,
John E. Bianchi, Ph.D.
Chairman of the Board
Bianchi International

Like you, I looked around and didn't like what I saw in government!

My own belief is that a strong country is made up of strong individuals — not a strong government!

The larger and stronger the government, the weaker the individual resolve. My goal is to set Arizona back on a course of individual responsibility.

I am running for governor because I hope to do by example in one state what our federal government has failed to do at the national level: return individual freedom and re-inspire individual strength.

You really are a great American and have probably done more in the 15 years of publishing *Soldier of Fortune* to sustain American resolve than any other effort in the same time frame.

Heartiest Congratulations!
Sam Steiger — Republican
Candidate for Governor
Phoenix, Arizona

It is a great pleasure to express my sincere and continuing admiration for what you have done at *Soldier of Fortune*. For 15 years you have stood almost alone in your fearless dedication to the publication of the truth. In these scruffy times, beset as we are with hypocrisy in government, ignorance in education, illiteracy in entertainment, perversion in the parlor, and, above all, obsessive fear of insult, injury, or death, your message gives us new heart. We are brothers-in-arms on the darkening plain, re-armed and re-loaded for the next assault.

Stout heart and good cheer!

Cordially,
Jeff Cooper
Gunsite Ranch,
Paulden, Arizona

On the occasion of *SOF* Magazine's 15th anniversary, I want to be in the forefront to congratulate you, your staff and your fine combat reporters.

Through the years that I've been associated with *SOF*, your efforts to identify the Soviet threat and confront it around the globe is truly remarkable for a private publisher.

It is evident that *SOF* combat reporters upstage all other media in reporting directly from the scene what goes on in the Soviet subversion efforts in the Third World countries.

I truly believe that our government's confrontations since World War II in Korea, Southeast Asia, Central America, Africa and in Afghanistan, along with the efforts of a few private compa-

nies and *SOF* Magazine, are responsible for the Soviet disintegration.

I remember *SOF* efforts in Central America and Southeast Asia because I was there with you.

The moral and financial support you provided to Third World countries struggling for their survival is also well known.

Throughout the years you could have lambasted the U.S. on its POW-MIA policy but in every case you checked out your intel data and yes, even provided it to DIA without compensation or even recognition. I'm sure your POW-MIA efforts have cost the magazine hundreds of thousands of dollars.

And last but certainly not least, you have supported dozens of humanitarian efforts in more than half a dozen countries. To the ACA and McCoskrie Threshold Foundation you have donated more than \$15,000 in cash, not to mention medical supplies.

You have taken the heat from every left wing kook in the country and paid dearly to defend yourself and your magazine's efforts. Even our own government while accepting your assistance has been at times critical of your methods.

I just want to go on record as being solidly behind you and your magazine. Rarely do we live to see the results that our efforts have contributed to. But *SOF* can sit back and watch the crumbling of the Soviet empire and know that you played a significant part.

With respect,
Gen. H.C. Aderholt, President
Air Commando
Association, Inc.

Please accept my sincere wishes for a successful convention. I applaud the many veterans who will be in attendance. Their dedication and service to our country will not be forgotten.

Sincerely,
John McCain
United States Senator

LAW ENFORCEMENT FOR SECOND AMENDMENT ... As quick as the Senate had passed the DeConcini Amendment on 23 May, I began reading in the press and hearing in the electronic media that the vote (52-48) had been a major defeat for the NRA

and a victory for the "coalition of police organizations that supported banning assault weapons."

By now, I'm sure the majority of *SOF* readers are quite aware that these nebulous "police organizations" are primarily comprised of transitory, yuppie administrators whose only concerns are the advancement of their own political and personal career agendas. The majority of these professional carpetbaggers have very short tenures and scurry from one job to another leaving behind nothing but bad memories and disastrous "progressive" programs in their wake. The Fraternal Order of Police does not speak for the majority of its membership.

Street cops, more than most, understand the value of the individual freedoms contained in the Bill of Rights. And they don't believe in restricting the freedom of the law-abiding as a means to fight street crime.

SOF is to be commended for encouraging readers to join the NRA and for providing free advertising space. Also encourage readers in law enforcement to join Law Enforcement for the Preservation of the Second Amendment (LEPSA). Rank and file cops must organize to counter the lies of these professional skills who claim to represent us.

Membership information can be obtained by writing: Tom Aveni, LEPSA, P.O. Box 999, Waterford, NJ 08089; phone (609) 629-8724.

Lt. Robert W. Parker
LEPSA State Representative,
Nebraska

GLAD YOU ASKED ... Can you please tell me an address where I can get info on joining the NRA. I'm in Panama so I can't use the phone number in the front of your July issue. Thank you!

Rob Webster, APO
Miami

You can write to the NRA at 1600 Rhode Island Ave N.W., Washington, D.C. 20036 and ask them for a membership application. Membership is \$25 a year and well worth it.

DURING THE MOST DIFFICULT TIMES ... in our struggle against the Sandino communists, we could always count on the physical and moral support of *Soldier of Fortune* magazine. This support lifted our spirits and kept us from thinking we were alone in our struggle. Only through your efforts were we able to know there are many Americans that realize the dangers and the threats posed by Managua.

Today, with the Berlin wall in pieces and the transformations in Eastern Europe, the situation appears to be easier and more controllable — only time will tell. In Nicaragua the problem has yet to be resolved. The Sandinistas are still holding a large quota of power. Nevertheless, all freedom-loving Nicaraguans and all those who are still striving for democracy must recognize that it is *Soldier of Fortune* magazine and Bob Brown personally who accompanies them into battle. This we will never forget. Happy 15th anniversary.

Enrique Bermudez,
Commanding General
Fuerza Democratica
Nicaraguense — FDN

BILL OF RIGHT-ON ... Thank you for your support of the Second Amendment. I'm not sure whether you're interested in one more opinion, but here is my "two cents." The message that I hope to convey to you and all Americans comes from the civics class we all had to take in high school. It is simply this:

Our rights were given to all people by a higher power than Congress. Our founding fathers only wrote them down. These rights were endowed by our Creator. They are inalienable. I think the folks now in Washington were absent the day the rest of us learned that lesson.

The guys who wrote the Bill of Rights knew about oppression. So, when they started writing, their first priority was to secure the freedom to speak and to be heard. In order to protect that right they wrote themselves an "insurance policy." We know it as the Second Amendment. Our Forefathers knew that the right to speak meant nothing unless that right could be protected.

Continued on page 130



SOUND DETECTOR

**DISTANT SOUND
DETECTOR
MULTIPLIES
SOUND 5000
TIMES**

\$148
postpaid

**The VanSleek
FARFOON®**

The VanSleek Farfoon generation of Distant Sound Detectors combines the best features of older models to bring you the most versatile unit yet developed. Utilizes a 3-1/2" built-in parabolic dish with "spider-mount" super-sensitive microphone for Sound Mirror effect, previously found only on larger, more cumbersome sound detectors. VanSleek features handy size (weighs about 2-lbs.), is easy to use in tight places. Made for professional hunters to hear approaching animals at great distance, the VanSleek has been discovered by the security industry. On city terrain, sounds leap across blocks and streets. Solid state-of-the-art circuitry. Sound cut-off. Powered by 6 penlight batteries for increased amplitude. Use VanSleek and enjoy mirrored sound gathering not possible with direct receiver products. Sold world-wide to government, military, police, hunters & fishermen. Discover the range of uses on land and sea; money back guarantee. \$148.00 postpaid.

Sword Cane



The Napoleon Bonaparte Eagle Sword Cane in stunning silver is one of the most beautiful sword canes we have ever seen. A true collector's piece from handle to sword tip, the detail of the silver Eagle's head perfectly complements the lustrous hardwood shaft (sheathed) and the tri-foil sword (un-sheathed). The sword is made of high-carbon steel; the shaft of finely turned beechwood. Overall length 36"; sword length from handle to tip, 32". Internal pin-in-channel mechanism locks/unlocks the sword. Made in France by that country's premier cane maker, and an absolute steal at \$160.00 plus \$3.50 shipping.

fectly complements the lustrous hardwood shaft (sheathed) and the tri-foil sword (un-sheathed). The sword is made of high-carbon steel; the shaft of finely turned beechwood. Overall length 36"; sword length from handle to tip, 32". Internal pin-in-channel mechanism locks/unlocks the sword. Made in France by that country's premier cane maker, and an absolute steal at \$160.00 plus \$3.50 shipping.

HIDING BOOK

**Protect your valuables
With our
Hiding
Book
\$24**
postpaid

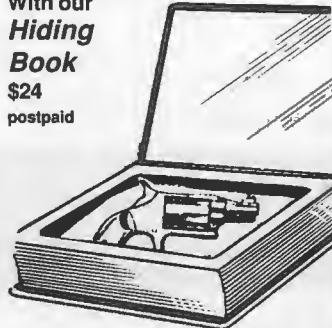

One of the slickest places to secrete money has always been in a book. Think of how many books a thief would have to look through. And now you can hide larger things...like a gun, or a box of jewelry...many things. And you can carry your hidden object with you in one of the "Hiding Books". Full size book, random titles used, handmade, and velvet lined in red. Brand new books. With cover closed you can't tell from any other book. The space inside is 5 x 8 inches. This is a top quality item. \$24.00

PHONE RECORDER



Electronic marvel tapes phone calls automatically. A "no hands" control for connecting cassette recorder to a telephone line, simply connect one cord to cassette recorder & the other cord into ANY modular jack in the house. Set recorder for "record" & whenever a receiver is lifted on any phone on the premises, the recorder will automatically record. When the receiver is hung-up, the recorder automatically stops. Just \$22.50 postpaid and that includes a FREE duplex adaptor.

Bug Box

**You Need The
BUG BOX For
Telephone
Privacy**



Telephone tap detector notifies you of unauthorized intrusion onto your line. Just plug modular phone into tiny BUG BOX, then plug BUG BOX into wall jack. An indicator light tells you when someone is "listening in". BONUS: Attach BUG BOX to every phone in your house, then you, AND ONLY YOU, can access the phone. BUG BOX not only tells you if someone else is on the line, it KEEPS THEM OFF with its privacy shut-out circuit. Buy one BUG BOX and use its indicator light to monitor line intrusion; buy as many BUG BOX's as you have phones and enjoy total privacy shut-out plus visible light indicators. Sale price \$30.00 postpaid.

TEAR GAS

MACE®

Don't mistake MACE with lesser tear gas aerosols. Chemical MACE delivers a potent punch of highly purified CN tear gas to incapacitate an assailant allowing you plenty of time to get away. MK-VI unit comes in individual gunlike case with real trigger action. Unique pistol grip allows quick hand orientation and sure action; attach to key-ring, purse or belt. Fires about 25 half-second bursts. Order one for \$14.50 and SAVE by ordering six for \$60.00.

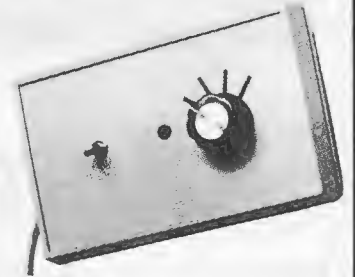

MINI BUG DETECTOR



This small, hand held bug detector sniffs out bugs transmitting on frequencies from 5 MHz to 1.5 GHz. Simply use its audio/visual signal to pinpoint the exact location of a working bug - as you get closer to the bug a tone gets louder and an LED bar display monitors signal strength. For discreet bug detection, the tone feature can be turned off. Runs on 9v battery. Order DT/70, \$245.00 plus \$3.50 shipping

For Protection & Surveillance Via Your Telephone Tele-Monitor 2000 lets you discreetly listen in on unusual activities on any premises via the telephone. Small device (5-1/2" x 3-1/2" x 1") plugs into any modular jack. Does not require beeper/pager. Takes just a touch tone phone. Simply call number Tele-Monitor is attached to, access by pushing the correct touch-tone buttons. Once activated, super sensitive mike picks up the most minute of sounds. Monitor computer & printer operations while you're away; use for security to hear any unusual sounds - smoke alarm, surge alarm, cries for help, muffled sounds of burglars at work. Compatible with any American phone exchange. Up to four units can be attached to one phone line, so you can monitor from room to room. Normal phone operations are not affected. American-made, state-of-the-art and priced right for just \$169.00 postpaid (additional units \$150.00 each).

WARNING: INTERCEPTION OF WRITTEN OR ORAL COMMUNICATIONS WITHOUT THE PERMISSION OF AT LEAST ONE PARTY IS PROHIBITED BY LAW.

The Name Is XONIX

The Cutting Edge Of Timepiece Technology
Take the BEST COMPONENTS from major companies like SEIKO, CITIZEN, NEC, MATSUSHITA, and WEST GERMAN concerns, then make a top quality watch part by part: That's the XONIX Analog Professional Diver's Watch. This is ONE GOOD LOOKING YET TOUGH WATCH to wear on land or in the deep. Top quality Seiko quartz movement...100% water resistant to 200-meters...two year battery...accuracy to +/-0.5 sec/day...mineral crystal lens...illuminated dial...shock proof movement holder...time ring bezel...stainless steel case back, support ring and stopper...the list goes on. This analog watch's large face is easy to read; displays date, too. Midnight Black band and case. This was Japan's best selling divers analog watch in 1987...now it's available in the United States at a special introductory price of \$48.00 postpaid. Order #QM2. OR, step up to GOLD or two-tone SILVER/GOLD (water resistant to 100m) band and case-back, your choice, just \$63.00 postpaid. Order #ROX-G (gold) or ROX-2T (s/g). Looks like a \$10,000 Rolex...but the name is XONIX. Full warranty - order TODAY the watch that's made smart so you don't have to pay millionaire prices!



MC/Visa & COD orders call toll free 1-800-821-5157

Mail in orders send check or money order to the address below.

The Dutchman
Dept. 1090
P.O. Box 12548
Overland Park, KS 66212

Please ship:
Item _____

Total \$ enclosed _____

Name _____

Address _____

City _____

State _____

Zip _____

©1990

WANTED

BY U.S. CUSTOMS
SERVICE OFFICE OF
INTERNAL AFFAIRS

ESCAPED FEDERAL PRISONER

GUSTAVO J. FERNANDEZ

Aliases: Papito, Gustavo Fernandez, Gustavo R. Fernandez, Gustavo Fernandez- Ravelo,
FBI No. 754066C Arthur Cobo

DESCRIPTION



Finger Print Classification

16 09 12 PO 12
22 13 12 12 13

| | | | |
|---|--------------------------------------|---------------------|-------------------------------|
| Date of Birth: | August 26, 1932 | Hair: | Brown |
| Place of Birth: | Havana, Cuba | Eyes: | Brown |
| Height: | 5' 04" | Complexion: | Fair |
| Weight: | 185 pounds | Nationality: | Cuban |
| Build: | Medium Frame, Large Belly | Other: | Birthdates August 26, 1936 |
| Occupation: | Vessel Captain | | Alien Reg.: A12421197 |
| Remarks: | Knowledgeable in the use of firearms | | |
| Scars and Marks: | Tattoos / Glasses | | |
| Social Security Number Used: | 584-82-5540 | | |
| Warrant Numbers: | W544005722 | | |

REWARD

UP TO \$50,000.00
FOR INFORMATION LEADING
TO THE APPREHENSION

CAUTION

FERNANDEZ SHOULD BE CONSIDERED ARMED AND DANGEROUS AND
SHOULD BE APPROACHED WITH CAUTION

A Federal warrant was issued on June 27, 1989 at Miami, Florida charging Fernandez with knowingly and willfully escaping from the custody of the Attorney General and his authorized representatives (Title 18 U.S. Code 751(a)).

IF YOU HAVE ANY INFORMATION CONCERNING THIS PERSON, PLEASE
CONTACT YOUR LOCAL U.S. CUSTOMS, OFFICE OF INTERNAL
AFFAIRS OR TELEPHONE 1-800-BE ALERT. (1-800 232-5378)

Entered NCIC

July 21, 1989



Leonard D. Freedman

LEONARD D. FREEDMAN
REGIONAL DIRECTOR OF INTERNAL AFFAIRS
U.S. CUSTOMS SERVICE
MIAMI, FLORIDA 33131
TELEPHONE: (305) 536-4371

(SPACE DONATED BY SOLDIER
OF FORTUNE MAGAZINE)

Go for the GOLD!



A winning tradition. Legendary quality. Springfield Armory's gold medal pistols are winners, every one.

1911-A1 PISTOL

The Springfield 1911-A1 pistol is the choice of the world's top action shooters, including three time IPSC World Champion and six time USPSA National Champion Rob Leatham. Winners choose winners, and the Springfield 1911-A1 is "The Winners' Choice".

P9 DOUBLE ACTION PISTOL

The 9mm Springfield P9 is the premium quality version of the famed Czech CZ-75. With a high capacity fifteen-round magazine, slim profile grips, a selective double/single action that allows it to be carried "cocked and locked", and a superior fit and finish, the P9 is the "the best of the best". There's even two sizes—standard and compact—and a new LSP model (Long Slide Ported) that's ideal for competition. Want to be a winner at the 9mm game? Say "Czechmate", and the game is yours.

OMEGA 10MM PISTOL

The Springfield OMEGA was the first production pistol capable of effectively handling high performance 10mm ammunition. Optional .38 Super

and .45 ACP are also available, and dual extractors make interchangeability of calibers a reality. The Springfield OMEGA. It's the "Perfect Ten".

1911-A2 S.A.S.S.™

Springfield's patented design for an affordable, single shot tack driver is the perfect choice for hunting or metallic silhouette shooting. With interchangeable barrels in eight calibers and two different lengths, and a choice of either a complete S.A.S.S.™ pistol or a S.A.S.S.™ conversion unit for your own 1911-A1 frame, S.A.S.S.™ is the perfect choice—all in one shot.

See the complete line of Springfield Armory gold medal pistols and rifles at any Authorized Springfield Retailer. Or, send \$3 for our 1990 four-color catalog.

Safety and instruction manuals available from Springfield Armory. Always wear eye and ear protection when using any firearm. Use only factory recommended ammunition. Ask your Authorized Springfield Retailer for details on Springfield's generous across-the-board warranty and service after the sale.

The Oldest Name In American Firearms
SPRINGFIELD ARMORY®

Section SH-23 ■ 420 West Main Street ■ Geneseo, Illinois 61254 ■ (309) 944-5631



DON'T MISS THIS ONE!

Last Plane Out!

Soldier of Fortune Magazine's 1990 Convention & Expo
Sept. 12 -16 1990, Sahara Hotel, Las Vegas, Nevada

Don't Miss the Action!

This is your last chance to sign on for this year's action-packed Convention celebrating *Soldier of Fortune Magazine's* 15th birthday. This is the big one that will make convention history! So pack a duffel and get out here! Have fun with people who really know how to rock 'n' roll. Action events include

- **Operation Headhunter.** Tough desert obstacle course.
- **Pugil Stick Tourney.** Three nights of jousts and cash prizes.
- **Firepower Demo.** Exotic heavy weapons, plus surprises.
- **Friends.** Meet your buddies, make new contacts.
- **Seminars.** Learn facts you won't hear on the news.
- **Expo.** See paramilitary weapons, police equipment, custom knives, and militaria at 160 booths. (No one under 13 admitted.)
- **Famous 3-Gun International World Championship Match.** Desert Sportsman's Rifle Club. Sept. 12-15. Over \$60,000 in prizes.

• **Special Events are** • Combat Medicine Workshop • Edged/Impact Weapons • Rappelling • Automatic Weapons Shoot • Live Ammo "Video Combat" Shoot • Defensive Driving.

Last Chance to Attend

Registration is \$150. Call Now at (303) 449 - 3750.

Or Register at the door.

To reserve your room, call the Sahara Hotel directly at 1-800-634-6666 and identify yourself as an SOF Conventioneer.



Don't Miss the Memories!

When the last shell casing has hit the ground after the Convention, when the last war story has been told, the last event won, and the last laugh shared, this year's SOF Convention will undoubtedly be remembered as one of the best.

Get your own memento of the action. Get a limited edition t-shirt or tank top as a remembrance of this special Convention celebrating *Soldier of Fortune Magazine's* 15th birthday. These high-quality, durable shirts are white with a silver, maroon and black design on the chest. All conventioneers will be wearing these distinctive shirts, which are sure to become collector's items in the years to come.

If you can't attend the Convention in person this year, we still want you to be part of its esprit de corps. We're making these t-shirts and tanks available to you by mail. Just order from the form, or call our toll-free number. Order Yours Now!

SOF EXCHANGE
P.O. Box 687 DEPT 10-90
Boulder, CO 80306 USA

Call Toll-Free for Mastercard, VISA or COD orders: 1-800-323-1776, Operator 131. For FAX orders: (303) 444-5617. Customer Service: (303) 449-3750.

PAYMENT: VISA /MC CHECK MO COD
CARD # _____
EXP _____ NAME _____
ADDRESS _____
CITY _____ STATE _____ ZIP _____

| QTY. | ITEM NO. | SIZE | PRICE |
|----------------------------------|----------|------|-------|
| | | | |
| | | | |
| | | | |
| SUBTOTAL | | | |
| P&H | | | |
| 3.7% Sales Tax (Colo. Residents) | | | |
| TOTAL | | | |

T-Shirt sizes S, M, L, XL. \$1.00 extra for XXL. Add \$3.00 for first item ordered plus \$1.00 per each additional item for postage and handling. Overseas orders add 40%. Allow 4-6 weeks for delivery.

- #9090 Convention T-shirt, white with one-of-a-kind silver, maroon and black 15th Anniversary design. **\$9.95**
 - #9190 Tank, white, as above. **\$7.95**
 - #9290 3-Gun Match T-shirt, white with black design. **\$9.95**
 - #9390 Tank, white, as above. **\$7.95**
- T-shirt sizes S, M, L, XL. \$1.00 extra for XXL

Look for Us at Our Booth

Come visit our booth at the Convention, and see firsthand our SOF Exchange merchandise. We'll be waiting for you.



America's newest screaming eagle keeps soaring to new heights of popularity!



EA-15E2 H-BAR

For match competitors who place a premium on accuracy.

If you want to fly where eagles dare, choose the .223 caliber (5.56mm) rifle that **American Rifleman** called: "...close enough to the semi-automatic AR-15A2 H-BAR for it to be considered a near-clone..."

The American-made EA-15E2 H-BAR from Eagle Arms means you won't have to settle for second best. No reduced capacity magazines, no chopping and restyling to make it look like something it isn't. Just an authentic military-style sporting rifle that upholds the tradition of the original AR-15 in its heyday. The EA-15E2 H-BAR even has several standard features that weren't available on the most recent models of the AR-15, like a fence-type protector around the magazine release button and an extra-thick, extra-heavy bull barrel that serves as a tremendous aid to accuracy. Add to that a forged upper and lower receiver made from extra-strong 7075 T6 aluminum, and the EA-15E2 H-BAR becomes a worthy successor to the original heavy barreled AR-15s that won their wings as superior target and varmint rifles.

How does the EA-15E2 H-BAR perform? According to **American Rifleman**: "...more than 600 rounds of ammunition were fired with no malfunctions of any kind! The...accuracy tables speak very clearly for themselves..."

The EA-15E2 H-BAR.

It just keeps flying higher, and higher, and higher.

For more information on the Eagle Arms EA-15E2 H-BAR, the Standard E1 model or carbine models with shortened barrels and collapsible buttstocks, call or write today.

**EAGLE
ARMS**
INCORPORATED

121 East 22nd Avenue ■ Coal Valley, Illinois 61240
Phone: (309) 799-5619 ■ FAX: (309) 799-5150

IN REVIEW

by John Coleman

WE'VE seen momentous changes in this world of ours since SOF's birth 15 years ago, the greatest certainly being the collapse of the Soviet "empire" and the subsequent democratic rebirth of many of its occupied satellites. Prior to the crumbling of the Iron Curtain, however, a good chunk of our military writing — both fiction and non — focused on the East-West cold war, or projected face-to-face U.S./USSR confrontations ranging from limited punch-ups to all-out nuclear war.

Now what? Unless some hard-line fanatic punches the button, chances are G.I. Joe and Ivan will end up on military exchange programs rather than facing each other over rifle sights. So, too, will our military writers need to refocus their battle zones, and that change is underway already. After all, there are — unfortunately — more than enough conflicts or potential conflicts to provide grist for the military writer's mill.

Barrett Tillman, an experienced naval aviation writer (who has also written for SOF in the past), sets up a plausible situation with **Warriors** (Bantam Books), a fast-paced thriller that unfolds in the Middle East. The situation: Israel has invaded and occupied Jordan to provide a buffer zone between itself and its not-so-friendly Arab neighbors. Saudi Arabia, walking the fine line of neutrality but well aware it could get sucked into an almost certain major conflict, hastens to beef up its air armory.

Enter John Bennett, former U.S. Navy commander with three combat tours flying in Vietnam — and some radical ideas (at least to the Navy hierarchy) about *fighter* aircraft and the men it takes to fly them.

The Saudis latch onto Bennett and his ideas, and have him create a secret and separate Saudi air wing called "Tiger Force." Its purpose? To match and beat, if necessary, the finest combat fliers in the world: the Israelis.

Bennett recruits a cadre of top instructor pilots from around the world (Tillman's loathe to call them mercenar-



ies, but that's exactly what they are) to fire up the best young Saudi pilots and put his own ideas of what makes top fighter pilots to work.

Training is one thing, however; combat is the final proof. As tensions build so do air clashes. Inevitably, Tiger Force is drawn into pitched battles with Israeli air. I won't give the ending of **Warriors** away, but it's as starkly real — and frightening — as tomorrow's headlines. Tillman kept me up two nights running with **Warriors**, and from this early-to-bed editor that's about the highest accolade I can give any book.

In another all-too-plausible scenario, Korea becomes the battleground for Ed Ruggero's **38 North Yankee** (Pocket Books). No mercs here; the hardcore North Korean military decides it's time to "reunify" Korea and invades across the 38th Parallel (hence the title, the code-word for just such an occurrence).

In **38 North Yankee**, Ruggero hooks us up with an infantry company of the 25th Infantry Division (Light), stationed in Hawaii and one of the first units to deploy to Korea to help brunt the North Korean drive south. It's a fairly chaotic exercise; Ruggero, an active-duty U.S. Army officer, knows that as well as anyone and aptly conveys just about every SNAFU, large and small, that his light fighters would run up against in the

real thing.

Where Ruggero really shines with **38 North Yankee**, however, is his portrayal of how young men transition from peacetime soldiers to shooting-war warriors (quickly, to say the least), and his realistic portrayal of how light infantry would be used — and misused — if the balloon really went up.

The light infantry concept was designed to create a fighting unit that could rapidly deploy, and the tradeoff was to sacrifice heavy equipment and weapons for that mobility. And if the bad guys should happen to field a battleground full of tanks before our own heavies can deploy? Ruggero gives us a pretty good idea what might happen to an undergunned light infantry unit in just such a circumstance (and

along the way also conveys a few damning indictments about the weaponry, especially antitank, with which our light fighters are currently armed).

Like **Warriors**, **38 North Yankee** also kept me up a few nights, and it's one of those books you wish didn't end. The good guys eventually win but at heavy cost, and if planners out there in the Pentagon kick around the serious questions this book raises, the cost might be a bit lower if Smith's fiction ever turns into fact.

Also new to our bookshelf are a series of first-class and highly recommended books ranging from World War II to Panama, all worth a bit of your disposable income.

First up comes **World War II** and three books whose contents will be self-evident by their titles: **Operation Drumbeat** — The Dramatic True Story of Germany's First U-Boat Attacks Along the American Coast in World War II (Harper & Row) by Michael Gannon, solid information on a little-known subject; **The Escape Factory** — The Story of MIS-X, the Super-Secret U.S. Agency Behind World War II's Greatest Escapes (St. Martin's Press) by Lloyd

Continued on page 128

COMBAT KNIVES - LIMITED SUPPLY

BUY YOURSELF A PIECE OF THE FOREIGN LEGION

Only \$79

First U.S.A.
Appearance

SILENCE - STEALTH - STRENGTH

Our unique combat knives have been supplied to the French Foreign Legion since 1989. We are pleased to be able to offer them to U.S. connoisseurs in limited supply.

These knives were developed by a former master commando instructor in cooperation with the First Regiment of the French Foreign Legion.

Check out these features:

- ★ P.C.S.® blued blade ★ VH carbon steel
- ★ Rockwell 60+ ★ 1/6.35" thick
- ★ 12 3/8" overall ★ Weight: 12 oz.
- ★ Zinc resin coated guard and pommel
- ★ Full Tang. ★ Razor sharp
- ★ Finest quality leather handle for longevity and toughness
- ★ Sheath: Cordura® ABS reinforced for rigidity
- ★ Machine washable
- ★ Shoulder wearing possible
- ★ Removable multi-function elastic Velcro® strips for safe jumping included

Most high standard knives lose their color and strength characteristics when reheated again and again in the field every morning with the "coffee-heating-no-burnt-finger" system... This Dagger WILL NOT.

FOR CREDIT CARD ORDER CONVENIENCE
FAX COMPLETED COUPON 1-303-660-8173
OR IN US CALL TOLL FREE 1-800-283-3638

P.C.S.-U.S.A. Box 908, Castle Rock, CO 80104
Gentlemen, please send me:

_____ P.R.O. Dagger(s) at \$79 each

SOF
10/90

Qty

Add \$6 Shipping/Insurance. CO residents add 3% sales tax

Name: _____

Address: _____

City: _____

Check/MO State: _____ Zip: _____

VISA/MC # _____ Exp _____

**ABSOLUTE MONEY BACK GUARANTEE
IF NOT COMPLETELY SATISFIED**

P.C.S.-U.S.A. Box 908, Castle Rock, CO 80104

P.C.S. France® U.S.A., Canada and E.E.C. Patent Pending



Photo: David Bjorkman

1990 SOF STAFF

Soldier of Fortune Magazine is a unique publication — and so is its staff. Independent and strong-willed (you have to be to survive around here), talented and professional just begin to describe the people who put SOF on the newsstand each month.

Working for SOF is a task that demands long hours, hard work, intelligence, flexibility and patience, and a well-developed sense of humor (all in the extreme measure). But it certainly offers its rewards, too: There's no other job that opens your eyes as widely to the world and what's happening in it than does a position with SOF.

Perhaps that's why the staff stays on instead of following more lucrative career paths in other fields — something each one of these people could easily do. That and the sense of

excitement and adventure we feel coming into the office each day, never quite knowing what new ambush lies in wait as we step through the front door.

And there *is* always something different around here, whether it's a frantic last-minute change to a magazine about to hit print (the norm), a frantic rush to get the right staffer to the right combat zone at the right time (the norm), or a frantic rush to find articles and photographs lost in the black hole of Bob Brown's office (ditto).

But it's worth it. At the end of the day we feel we've contributed our bit toward keeping you informed and, we hope, entertained. We're glad you picked up this issue and celebrated our 15th Anniversary with us. Good to have you aboard!

— John Coleman ✕

THUNDERZAP

| | | |
|---|---|---|
| EXCEEDS 3000FPS FROM A 6" BARREL | EXCEEDS 2800FPS FROM A 4" BARREL | EXCEEDS 2600FPS FROM A 2" BARREL |
|---|---|---|

THUNDERZAP VELOCITIES ARE BASED ON AN AVERAGE OF TEN (10) TESTED ROUNDS

and "0" FPS at 100 yds.

UNBELIEVABLE... BUT TRUE!!!

HIDEOUS SHOCKING POWER!

- Explosive impact energy: vicious flesh destruction.
- Shatters ribs and blows rib pieces into lung tissue.
- (See photo at right) Top entry wound into animal rib cage was the result of the .38 Thunderzap. Entry wound below made with .44 mag hollow point.

DEVASTATING STOPPING POWER!

- Complete energy is consumed on impact with target.

DESIGNED FOR CLOSE ENCOUNTERS!

- Over 90% of all gunfights in U.S. are within the 21-foot range.
- "Urban-safe"... will not exit human body; ricochet-proof.
- Very low wall-penetration for NARC raids or home defense.
- Velocity is ZERO at 360-feet reducing contact percentage with innocent bystanders in a street gunfight.



4" .38-2800FPS at muzzle "0" FPS at 100-yards

- PLUS:**
- LOW RECOIL DUE TO 32gr PROJECTILE
 - NON-LEAD PROJECTILE SAFE FOR INDOOR RANGES
 - .38 MATCH AMMO ACCURACY

ORDER YOUR THUNDERZAP AMMO TODAY!

BOX OF 50 .38 ROUNDS: \$40.00 • SAMPLE 10-PAC: \$10.00

ALL ORDERS POSTPAID • NO C.O.D.s

SOF

PLEASE SEND ME THE FOLLOWING .38 THUNDERZAP AMMUNITION:

___ BOX(ES) of 50-rounds at \$40.00 per box \$ _____

___ PAC(S) of 10-rounds at \$10.00 per packet \$ _____

Total amount of this purchase: \$ _____

Make check or money order payable to: **THUNDERZAP, INC.**
(Print ALL Information)

NAME _____

ADDRESS _____

CITY/STATE/ZIP _____

TELEPHONE CO.: (In case of inquiries about this order) A.C. _____ - _____

MAIL THIS ORDER FORM WITH REMITTANCE TO: THUNDERZAP, INC., P.O. BOX 579, CENTRAL LAKE, MI 49622

NO SALES TO PERSONS UNDER 18-YEARS OLD. PROOF OF AGE REQUIRED WITH EACH ORDER.



**INSTANT
SATISFACTION**
•
**IMMEDIATE
RESULTS**

THE NEW 9MM AUTOMATIC

Ruger P85



More Than World Class,
World's Best

While other firearms companies tell of their history, Ruger is making history with new design, new technology, quality control and extensive testing.



STURM, RUGER & Company, Inc.

123 Lacey Place, Southport, Connecticut 06490

Free instruction manuals for all Ruger firearms are available upon request.

Entire contents ©1987, Sturm, Ruger and Company, Inc.

COMBAT CRAFT

by George T. Williams and Daniel C. Frenel

Raids

RAIDS are usually short, low technology, low support operations.

They secure information, harass the enemy or disrupt his supply and support installations. Raiders generally carry minimal personal supplies in deference to more ammunition and explosives. Although raids will have different objectives, they all consist of three phases: Planning and Approach, Assault, and Withdrawal/Extraction.

Planning

and Approach: Plans must consider that raids are minimum exposure, maximum impact missions against critical targets. Targets are usually the soft, vulnerable points of enemy infrastructure — airfields, ordnance facilities, POL dumps, ammunition dumps, electrical facilities and barracks. Raids may also be conducted to attack or capture specific enemy command personnel. Raids are easier when the objective is far enough to the rear to be operating on a business-as-usual basis. Remote from the fighting, enemy patrols may be infrequent and casual. When sentries are bored and inattentive and overall security is not as tight as it should be, the raiding team should take every advantage.

Although plans can be modified during the mission, for example to take advantage of unexpected targets of opportunity, the size of the raiding party and the weapons they carry should reflect the requirements of the raid. While a mortar might be handy to allow a stand-off attack, large mortars are heavy and the limited number of rounds the team can carry might make it impractical. A small patrol mortar, or RPGs and LAWs if the objective is a



Raider, backed up by another team member, prepares to take out sentry en route to target.

Photo: courtesy authors

point target, are more appropriate. Individual weapons, except sniper rifles, will generally be for the raiding party's personal protection. Explosive charges appropriate to the mission should be selected and prepared in advance. Anti-personnel mines such as claymores should be carried in case a hasty ambush is necessary to slow any pursuing enemy troops, and for overnight position security.

Each team member must be thoroughly briefed on every aspect of the mission. Each should know the objective, his job and the target assignments of each team member, proposed route to the target, Rallying Points (RP), routes of withdrawal and location of the Extraction Point, if any.

Once in the AO, team OpSec is critical. The team must avoid all contact with the enemy and locals. Raids are successful only when the enemy is unaware. Hand signals, writing or low whispers should be used to communicate. Absolute noise discipline is necessary. No fires, no smoking. Odors from soap, aftershave, or mint-flavored chewing tobacco can give you away. Body odor can become a problem, but GI soap will suffice. Boot prints may

give away your presence, so select your route accordingly. Leave nothing behind — bury it or carry it. If the enemy stumbles on your fresh tracks or trash, they will start looking for you and tightening their security, both of which can endanger your mission.

Raiders must exercise caution traveling on trails, crossing roads and in gathering water. Trails should be avoided because of mines, boobytraps and enemy patrols or ambushes.

Crossing roads is hazardous; security elements should be put out to warn of traffic or patrols, and the road crossed quickly. If water is not plentiful in the area, water sources may be guarded by the enemy and extreme caution should be observed near them.

At the objective, final target observations are made and existing plans reviewed and adjusted as necessary. Enemy security is studied for weak points, and one- or two-man patrols may be sent for a detailed recon of the target to find vulnerabilities such as blind spots, perimeter weakness or sentry routines.

The Assault: Depending on the size of the party, team members are divided into three elements: The largest is the raiding party that does the actual assault; second is a security element to provide flank security and hold avenues of withdrawal; finally, a reserve element to provide diversions, support fire or reinforce the assault element.

The assault phase should do as much damage as possible in the shortest time. The options are for a Standoff Attack, a Raid-In-and-Out or a Raid

Continued on page 107

GUNSTOCK

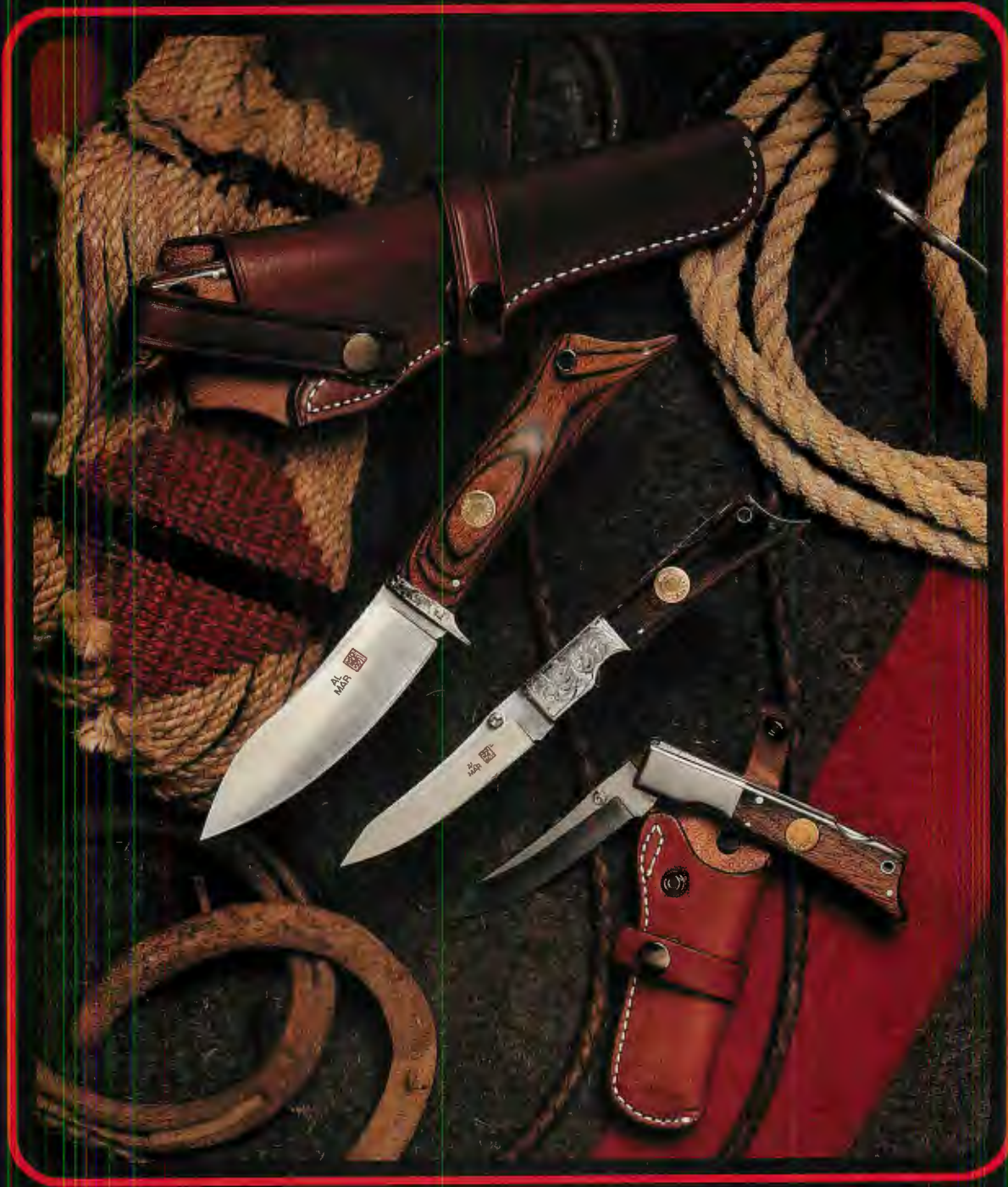

Al Mar Knives 5755 SW Jean Road Suite 101 Lake Oswego Oregon 97035 USA 503/635-9229



THE OFFICIAL MILITARY ISSUE GENUINE LEATHER A-2 FLYING JACKET

A Piece of American History.

The A-2 Leather Flying Jacket is one of the most famous pieces of battle gear in history. During World War II, the brave pilots of the U.S. Army Air Forces relied on the A-2 for protection and comfort. Worn by the daring "Flying Tigers" who fought over China in their P-40 Warhawks. And Jimmy Doolittle's B-25 bomber squadron that hit Tokyo in a daring carrier-launched raid. Lightweight and comfortable yet "tough as nails," the A-2 identified its wearer as one of an elite, brave breed of fighting men.

Genuine Military Issue. Not a Commercial Reproduction.

Cooper Sportswear was an original supplier of the A-2's worn by America's World War II flying heroes. Now, after a 45-year retirement from active duty, the U.S. Air Force has recommissioned the A-2 and selected Cooper as the official Government contract manufacturer. Now, you can own the *very same* jacket issued to U.S. Air Force pilots.



Not a reproduction — this is the genuine article!

Proudly Made in the U.S.A.

The Cooper A-2 is made in the U.S.A. using materials and production methods specified by the U.S. Air Force. Premium hand stitched goatskin ensures ruggedness and great looks. Knitted cuffs and waist band and a spun cotton-blend lining ensure draft-free comfort. Details include regulation snap-down collar, shoulder epaulets, and roomy snap-close pockets. You'll also receive a certificate of authenticity stating that yours is *the* U.S. Air Force A-2. Battle-proven and built for long life, the Cooper A-2 actually gets better-looking with age.



Payable in Convenient Monthly Installments.

The Cooper A-2 Leather Flying Jacket can be yours for just \$249 (plus \$7.50 shipping and handling) payable in six convenient monthly installments of \$42.75 charged to your credit card. Satisfaction guaranteed. If you are not delighted with your jacket, simply return it in original condition within 30 days for exchange or refund.



*The actual jacket supplied
to the United States Air Force*

Order today. Available in even sizes 34-52 regular and long. Call about larger sizes (to 60) available for \$50 more. (For best fit, order one size larger than your normal jacket size.)

Normal delivery on phone orders 4-8 business days.

CALL TOLL-FREE: 1-800-367-4534

© 1990 MBI

Willabee & Ward
47 Richards Avenue
Norwalk, Conn. 06857



Satisfaction
Guaranteed

CALL TOLL-FREE: 1-800-367-4534

Please send me _____ Cooper A-2 Genuine Leather Flying Jackets.
Size (Even sizes 34-52): _____ Regular Long

Charge each of 6 installments of \$42.75* to my credit card.
 Mastercard VISA Discover Amer. Express

Credit Card # _____

Exp. Date _____

Name _____
(PLEASE PRINT CLEARLY)

Address _____

City/State/Zip _____

Signature _____
(ALL ORDERS SUBJECT TO ACCEPTANCE)

I prefer not to use a credit card and will pay by check.
Enclosed is my check for \$249 plus \$7.50 shipping/
handling, a total of \$256.50*.

*Any applicable sales tax will be billed with shipment.

606-237



Summer '75

- SOF's first issue. RKB keeps subscription checks in a shoebox until he's sure the magazine will sell — it does
- We run our first Vietnam article that allows vets to tell their own story. At least one has run in nearly every issue since

Spring '77

- First of many treks to embattled Rhodesia
- PMRS deploys to Guatemala to assist earthquake victims
- SOF jumps in South Africa

July '79

- First of many treks to Lebanon

Sept. '79

- First trek to Uganda

Oct. '79

- SOF offers \$10,000 in gold for the return of Idi Amin (in one piece) to Uganda

Spring '76

- Parachute Medical Rescue Service (PMRS) founded; they jump into Honduras to assist hurricane victims

Mar. '79

- SOF jumps with Confederate Air Force

- PMRS deploys to Dominican Republic to assist hurricane victims

Fall '76

- SOF Correspondent George Bacon dies in Angola — the first of too many: Mike Echanis and Peter Bertie in Nicaragua, Almerigo Grilz in Mozambique, and Lance Motley in Burma

May '79

- Soviet defense journal officially recognizes — and attacks — SOF and RKB, the first of many such jabs for years to come. We're obviously doing something right

Nov. '79

- SOF's firsthand reports of Somoza's fall and the Sandinista takeover of Nicaragua

Dec. '79

- Soviet invasion of Afghanistan

SOF'S World at War

by
SOF Staff

We're adventure junkies, and we'll be the first to admit it. Even more, we're *curious* adventure junkies. It's not enough to wander in and out of combat zones; we've got to stick our noses in the front lines (and sometimes beyond) to take our photos and write our copy. And, when *that's* not enough to satisfy the itch, we sometimes pick up a rifle and join in. We call it participatory journalism.

That's been the name of the game at *Soldier of Fortune Magazine* — going and doing — and it's made us unique in the publishing industry. Where others were satisfied with government press releases, our staff and correspondents were slogging through the jungles, or across deserts, or over mountains under the worst conditions for weeks at a time to bring back major stories about forgotten peoples fighting for their freedom.

But our commitment to "go and do" didn't end there. When the cause was right we supplied money, equipment, medical and other supplies, training and expertise. Money came out of our pocket, services were volunteered, and tons of equipment and supplies were donated by our readers. It all made a big difference to the mujahideen in Afghanistan, the contras in Nicaragua, troopers in El Salvador, and thousands of refugees forced to flee their homelands in search of freedom. Even more, we made their causes ours and kept their stories alive in the pages of this magazine long after they were forgotten by everyone else.

Admittedly, however, a lot of what we've gone and done has been for the pure hell of it. We are after all "The Journal of Professional Adventurers," and you don't find much adventure sitting behind a desk, watching life pass by outside the window.

We haven't been able to cover it all on this and the next four pages — it's just a quick glimpse into 15 years of *Soldier of Fortune Magazine*. For us, the adventure's just beginning...and we hope it is for you, too. ✕

Jan. '80

● SOF organizes Afghan Freedom Fighters Fund to assist in providing medical and non-lethal military aid to the mujahideen

March '80

● SOF offers Khomeini target. Too bad it wasn't the real thing

April '80

● First of many treks to Afghanistan, Angola's UNITA, and El Salvador. SOF would provide the most comprehensive coverage of Afghanistan's and Angola's fight for freedom of any world media; we'd send numerous military and medical training teams, along with thousands of dollars of medical and non-lethal military supplies, to El Salvador

July '80

● SOF attacked in United Nations for "mercenary" activities. We appreciated the media coverage

Sept. '80

● First Soldier of Fortune Convention

● First of many training and assistance teams to Afghan freedom fighters

Dec. '80

● First trek to Morocco

Jan. '81

● First of many treks to Cambodia

Mar. '81

● SOF begins intensive Southeast Asia POW/MIA investigative efforts

Aug. '81

● First trek to Northern Ireland

Sept. '81

● First on-site coverage of the Nicaraguan contras. Many training and medical assistance teams would follow, along with tons of medical and non-lethal military gear

Nov. '81

● First of many treks to Thailand
● SOF testifies before the Senate Foreign Relations Committee on communist use of toxic agents around the world; we offer a \$100,000 reward for the first pilot spraying same to defect

Jan. '82

● SOF establishes Liberty City base camp inside communist Laos to track down U.S. POW/MIA



SOF's RKB making friends in southern Africa



Good and bad — SOF's T&E'd hundreds of weapons over the past 15 years



Morocco. SOF's traveled the length and breadth of Africa.



Staffer Tom Reisinger in Laos helping to track down U.S. POW/MIA

If they were elite we covered them, including these French Foreign Legionnaires in Djibouti, East Africa. SOF Convention Director Bill Brooks knew the place well — he served there with the Legion.



INSET: SOF's words to live by — "Death to Tyrants."

Aug. '82

• SOF concludes 18-month on-site investigation of U.S. POW/MIA in Southeast Asia. After investing countless man hours and \$250,000, we're unable to turn up irrefutable evidence — just a series of tantalizing and frustrating leads

• SOF organizes Refugee Relief International, Inc. (RRII) to provide humanitarian aid to those fleeing communist countries

Sept. '82

• First of many treks to the Philippines

Oct. '82

• SOF jumps C-130 and balloon in Thailand

Nov. '82

• Vietnam memorial "Wall" is dedicated in Washington. SOF lobbies hard for something better
• RKB fulfills a life-long dream and mortars a Soviet fort in Afghanistan

Jan. '83

• SOF organizes El Salvador/Nicaragua Defense Fund to provide medical and non-lethal military supplies to the contras and Salvadoran military

Feb. '83

• SOF goes to war with El Salvadoran military

June '83

• SOF's POW/MIA special issue. While others were trying to forget, we remembered

July '83

• First trek to Liberia
• SOF jumps in Guatemala and El Salvador. Our coverage of both countries would continue to expand

Aug. '83

• First trek to Costa Rica

Sept. '83

• SOF's first (but not last) firefight in El Salvador

Oct. '83

• First trek to Korea

Feb. '84

• SOF hits the beaches of Grenada during Urgent Fury and uncovers secret

Oct. '84

• SOF jumps in Israel

Nov. '84

• First trek to Belize
• SOF's and many others' efforts pay off with the dedication of Frederick Hart's bronze sculpture of the three grunts at the Vietnam Veterans Memorial in Washington

documents overlooked by U.S. Intelligence. We begin a series of articles on the troops who fought

Apr. '84

• First of many treks to cover the Karen freedom fighters in Burma

Aug. '84

• First of many treks to Suriname
• RRII combines with Air Commando Association to provide medical training and supplies to El Salvador

Jan. '85

• First trek to Zimbabwe

Feb. '85

• SOF revisits Vietnam (as tourists this time)
• We reprint the CIA's "Psychological Operations in Guerrilla Warfare" manual



ABOVE: South West Africa
BELOW: Afghanistan, and another tech scoop



Northern Ireland



Correspondent Almerigo Griz traveled for us to Ethiopia, covering the Oromo guerrillas. Griz was later killed in Mozambique



Mar. '85

- SOF offers \$100,000 reward for the first Nicaraguan pilot to defect with a Hind D helicopter

May '85

- First trek to Jordan

June '85

- SOF training team goes inside Nicaragua with the contras

Aug. '85

- SOF's 10th Anniversary Special. No one thought we'd make it this far; many hoped we wouldn't

Sept. '85

- SOF's reward offer for the Hind D is bumped up to \$1,000,000 with the assistance of LTC Oliver North. No one defected, but subsequent reports indicated we kept that part of the Sandinista air force grounded for six months

Feb. '86

- First coverage of RENAMO, Mozambique's freedom fighters

Apr. '86

- We're doing such a good job in Central America that left-wingers march on our Boulder office. We ignore 'em, which really pisses them off

May '86

- First SOF reports on the People's Republic of China (PRC)

June '86

- SOF offers Khadafi target. Too bad it's not the real thing
- SOF jumps in Taiwan
- First of many treks to Colombia

July '86

- SOF exposes suspect POW/MIA identification operations at Central ID Lab in Hawaii

Aug. '86

- SOF's special Libya issue — the American attack. Too bad we missed. We begin our first of many articles and specials on the war on terrorism

Jan. '87

- First trek with the Philippine New People's Army communist guerrillas

Feb. '87

- First of many treks to Sri Lanka and Ethiopia

Apr. '87

- We aren't mercenaries but we cover them: in-depth look at the abortive Ghana coup attempt by American mercs

May '87

- RKB and John Donovan make their major movie debut in "Hostage." It did not win any academy awards

June '87

- First of many treks to Bolivia

Sept. '87

- SOF is invited by the PRC government to exclusively report on their small arms, and we print the first of an eight-part series

Oct. '87

- Pilot John Piowaty's exclusive first-hand account of the (Iran)/Contra airlift

Nov. '87

- We begin our "war on drugs" coverage with the California pot wars, the first of many articles to come
- SOF offers a \$25,000 reward to the first Cuban or Nicaraguan security/intelligence operative who defects during the PanAm games. Cuban delegation lodges a formal protest...who cares

Tech Editor Peter Kokalis has run extensive weapons courses for troopers in El Salvador, his latest in June 1990.



Special Projects Director Alex McColl (right) with Dr. John Padgett getting needed supplies to El Salvador



Dec. '87

- We reprint Ollie North's slides, something Congress wouldn't let you see

Jan. '88

- SOF's exclusive report on Soviet Spetsnaz working inside the United States
- SOF rescues missionaries held inside Mozambique

Feb. '88

- SOF exposes Army's M9 bayonet fiasco

Sept. '88

- SOF jumps in Peru; our coverage would continue

Jan. '89

- SOF Editor Don McLean reveals FDR's secret plan (nearly implemented) to bomb Japan prior to 7 December 1941

Feb. '88

- First trek to Chad

July '88

- SOF jumps in Mexico

Aug. '89

- SOF jumps in the Dominican Republic

Oct. '89

- SOF reveals secret Delta/SEAL plan to rescue American hostages held in Lebanon

Nov. '89

- We win our four-year court battle over personal services ads
- SOF rescues an English journalist held in Mozambique

Jan. '90

- We're the first Western journalists to train with Soviet paratroopers

Feb. '90

- SOF jumps in Venezuela

Apr. '90

- We trek to Panama — along with the rest of the U.S. military — during Operation Just Cause, and begin a series of articles on the troops who fought

May '90

- SOF unmasks El Salvador church merc Jennifer Jean Casolo
- Once again, SOF fights alongside Salvo paras against the guerrillas

June '90

- Another inside look at mercenaries: in-depth article on Brit mercs and the drug lords in Colombia

July '90

- SOF buys Mikhail Gorbachev membership in Handgun Control, Inc. They cash our check

Aug. '90

- SOF treks with the H'mong freedom fighters in Laos

Sept. '90

- We continue our series on

the troops who fought in Panama, our first-person accounts of Vietnam, our war on drugs, and our in-depth coverage of Thailand, Afghanistan and El Salvador

Nov. '90 — onward

- SOF continues to "go and do"

RKB in Grenada. We slipped ashore and managed to uncover secret documents overlooked by U.S. Intelligence



ABOVE: SOF's covered Jonas Savimbi's UNITA freedom fighters in Angola since 1980

BELOW: Art Director Craig Nunn broke loose from the office and wound up in a Rhodesian firefight



PROFILE IN COURAGE

SEAL Cop Cool, Brave and Heroic Under Fire

by Morgan Tanner
Photo by David Bjorkman

WHEN Ron Relf saved a woman and her baby while he was under direct fire, he credited both his SWAT and his SEAL training for his level-headed response.

"Every time we do a no-knock warrant, we're going into a combat zone," says Ron, a Denver, Colorado, SWAT team member and former SEAL. "Our uniform is different, our rules of engagement are different, but just like in the military, it's the nature of the work that you're going to confront armed suspects, and you have to make the right decision at the right time."

Just after midnight on 25 January 1990, Ron made a decision that saved three lives: those of a pregnant woman, her unborn baby and the two-year-old child in her arms. Ron was on the entry team that burst into a dark house on a no-knock search warrant. It was business as usual: a suspected cocaine dealer who was "armed, possibly dangerous, who wouldn't hesitate to shoot a police offer." Moving down a dimly lit hall, Ron noticed a door his teammates had passed.

"I figured it was a closet or stairwell," he says now.

Instead, it opened into a tiny, pitch-black bedroom where a man waited with his 9-shot .22 revolver. When Ron entered the room, a round whizzed by him, narrowly missing his head. At the same time, the dark form of a woman with a baby came running directly into the line of fire.

"My first thought was to protect the baby," he says. "You get innocents caught in a gunfight, what do you do? Get them out of the way so you can continue."

His assailant cracked off another round, and Ron felt it whiz by his cheek. But even under attack, he held his fire for fear of harming the baby.

"I realized then that I was silhouetted in the doorway," Ron says. "I knew I had to go for it. If I backed out, we'd have a barricade situation with hostages."

With his left hand, he pushed the woman and baby out of harm's way, dropping his flashlight in the process. Then, he lifted his 9mm SIG-Sauer P226 and shot where he

had seen the dim light of a muzzle flash. In the muzzle flash of his own gun, he could make out the shape of a man kneeling on the bed firing at him. The man fired a third and possibly a fourth time before his gun dropped.

Ron quit shooting and retrieved his flashlight. In its yellow light, he could see the bleeding man's defeated look. He stepped forward and brushed the revolver out of his reach. Then, Ron's cover and other team members stepped in and took care of business: cuffing the man and moving the woman and baby to the living room. A search of the house revealed \$8,000, half an ounce of cocaine, and a shotgun and high-powered rifle under the bed.

"I was worried about the woman and baby," Ron said. "They were screaming, but I checked them over, and there was no blood. So I went outside and sat on the step."

Outside in the frigid night air, Ron thought about his days as a SEAL. From

1970 to 1979, he served on UDT 12 and then SEAL Team 1 based in Coronado, California. He was one of the first 14 men to work on the counterterrorism SEAL platoon "Contingency Team," which became Team 6. SEAL training was thorough and tough.

"Some nights, I felt like packing it in, but I always figured I'd wait till morning," he recalls.

By morning, he always figured he could make it one more day. Of the 114 who started training, Ron was one of 11 who finished. He received the Navy commendation medal when he helped rescue 16 hostages on 20-22 December 1977, during a bank robbery at Subic Bay Naval Station in the Philippines.

"What I liked was the closeness of the team and our ability to work together without egos," he says.

A SEAL hospital corpsman, Ron applied to medical school, planning to become a

Continued on page 126



"Whereas it is realized that the great bulk of police work is done routinely by good police officers, let it be known that the officer named herein displayed initiative and alertness decidedly in excess of the norm in this particular instance ... Technician Ron Relf's heroic act while under fire demonstrates true professionalism on his part and reflects credit to all members of the Denver Police Department."



JUST CAUSE JAILBREAK

*American Pirate Radioman Risks Death
Raiding Noriega's Airwaves ... Enter Delta Force*

by Neil Livingstone

AS Kurt Muse approached his first Christmas in Panama's Modelo Prison, he was having trouble sleeping. During eight and a half months of captivity, he had adopted an arduous exercise regimen designed to occupy the empty hours and to tire himself out so he could sleep at night. He had shed more than 40 unneeded pounds on what he jokingly referred to as the "Noriega Diet and Exercise Plan." With the exception of nights when the torturers were at work and the screams of their victims gave him nightmares, Muse normally had little trouble drifting off once he lay down on his cot for the night.

But now, on 19 December 1989, things were different. He was filled with a sense of impending doom. Events, says Muse, had been "moving at warp speed" in recent days, and he wasn't certain if he would ever see another Christmas.

Muse's second floor cell was located just across the street from the Comandancia, Panamanian dictator Manuel Noriega's headquarters. The previous Saturday night,

ABOVE LEFT: "Angel Gabriel," Muse said softly as he looked down on the PDF bustling around the Comandancia, "nuke 'em." He almost got his wish, but would he live to see the results of his efforts? Photo: Eric Fatzinger, courtesy Jack Finch

INSET: West end of Comandancia. Entire 4th floor was damaged by fire support from Spectre gunships, attack helicopters, Sheridans, 25mm guns on USMC LAVs, 4-6 Mech Inf. .50 cal and Ranger assault fire. Photo: J.J. Moore, courtesy Jack Finch

LEFT: Muse was definitely in the middle of the action. Note proximity of Modelo prison (rectangular building in foreground) to burned-out Comandancia in background. Photo: courtesy Jack Finch

INSET: Kurt Muse's home away from home at Modelo Prison. Photo: courtesy Kurt Muse

shortly after 2100 hours, he'd heard gunfire coming from the direction of the Comandancia. Not long afterward, the Comandancia was blacked out, light armored vehicles were moved into position around the facility, and machine guns were placed in defensive positions. The situation settled down later in the evening and the following day Muse was still trying to figure out what had happened.

On Monday morning, as usual, he was scheduled to meet with U.S. representatives, who visited the Modelo each workday to check on his health and well-being. But this Monday, 18 December, he was taken to the infirmary, where the meetings occurred, under unusually tight security. There were guards all around him. "I couldn't speak, whisper, wink, signal, anything, to anybody without them taking note of it," he remembers.

There was another American in the Modelo, a common criminal who had killed his wife. Since the man was suffering from tuberculosis, the American doctor who was part of the U.S. team had asked to examine him also. While the doctor concluded his examination, Muse was placed on a bench outside the infirmary to wait his turn.

While he was waiting, Muse could see a Panamanian major, who had taken part in one of the coup attempts against Noriega, motion to him from his cell. In sign language the major described the murder of Marine 1st Lieutenant Robert Paz at a PDF



Kurt Muse in much more pleasant surroundings than his Modelo Prison cell. Photo: Neil Livingstone

checkpoint near the Comandancia on Saturday night.

"Last Saturday" (reverse motion), "across the street" (pointed in the direction of the Comandancia), "shots" (pretended to shoot a rifle), "American" (pointed to Quarry Heights), "officer" (pointed at rank on shoulder), "killed" (slashing motion across the throat).

Muse was stunned by the news, and at the same time alarmed. "I knew that the U.S. would not permit Noriega and his bandit thugs to go around killing American servicemen," Muse says. "I felt that something was going to happen, that it was the final straw."

It was clear to Muse that Noriega's days were numbered, but the question was: would he be alive to see the dictator's downfall? After all, Noriega had threatened that Muse would be one of the first to die if the United States took any action against his regime. It was no idle threat. An executioner was positioned behind a desk at the end of the corridor leading to Muse's cell; at the first sign of trouble he was supposed to walk down the hall and kill Muse.

For the past two days, Muse had watched the Panamanian Defense Force (PDF) working feverishly preparing the defenses around the Comandancia for what many believed was an imminent attack by the United States. "You could cut the tension in the prison with a butter knife that day [the 19th]," he remembers. When evening rolled around, instead of adhering to his exercise schedule at 0700, Muse sat gazing out the window and reflecting on a letter that he'd received from this aunt, a charismatic Episcopalian who advised him to pray to the Angel Gabriel for deliverance.

"Angel Gabriel," Muse said softly, under his breath, as he looked down on the PDF bustling around the Comandancia, "nuke 'em."

Later, the guard from the end of the hall wandered over to chat. After making a little small talk, Muse couldn't resist asking the question that was consuming him that evening. Even though he dreaded the answer, he had to know.

"If something happens," he inquired, "would you really shoot me?"

"Yes," responded the guard without hesitation.

Visions of the guard coming down the corridor, opening the cell door, and raking his cot with an assault rifle flooded Muse's head that evening as he struggled to fall asleep. He vowed that he wouldn't die without putting up a fight. His only weapon was the aluminum brace from beneath his cot. Not much of a weapon, but at least it was something. If trouble started, he would grab the brace, hide in his bathroom, and club the first man that came into his cell. It wasn't much of a plan but the very thought that he wasn't completely helpless had a calming effect on him, and sometime before midnight he drifted off to a fitful sleep.

Rotarians From Hell

The events that had resulted in Muse's incarceration by one of the world's most ruthless dictators could be traced back to his purchase of a Radio Shack police scanner in Miami several years earlier. Such scanners were illegal in Panama, but as opposition to Noriega grew, Muse eavesdropped on PDF communications as they tried to cope with the mounting disturbances in the streets.

Muse had been raised in Panama, but like most Americans citizens living in the country, he and his family had always avoided local politics. He graduated from the University of Texas at El Paso (UTEP) and, after serving in the U.S. Army, Muse returned to Panama with his childhood sweetheart, whom he had married while in school, to go into the family printing business. But as Noriega's gangster state

became ever more corrupt and brutal, Muse finally decided that he could no longer remain a bystander.

With other members of his local Rotary Club, all of them Panamanian citizens, Muse formed a small group to systematically listen in on the PDF and break their codes. "I was like a fly on the wall," he says. "I overheard drug deals being transacted over the air in a relaxed and routine manner. I remember a conversation between two Noriega cronies about a major drug transfer that was to take place in the parking lot of a popular supermarket. In addition to the usual arrangements, and as a token of good will, the client wished to donate 15 M16s to El Comandante [Noriega]. A call was made to the head of the traffic police requesting that all police be recalled from the area. On cue, minutes later, a call went out on the police net ordering the officers to return to headquarters for a meeting."

In the beginning, says Muse, he and the

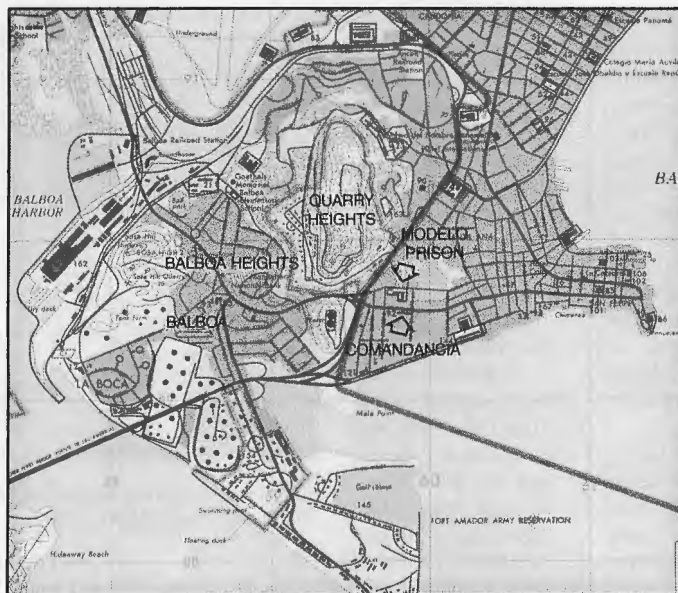

Modelo Prison and Comandancia in the middle of Santa Ana district of Panama City.

other Rotarians had little knowledge "of what UHF and VHF or anything was. We simply grabbed blocks of frequency and scanned them to find communications." Over time, they isolated most of the PDF and government communications channels and listened in. Since the PDF often spoke in a combination of alpha-numeric codes and military slang, they also were forced to become what Kurt calls "Rotarian cryptographers."

They also started eavesdropping on cellular phone conversations. Mostly they heard Noriega cronies talking to their mistresses, describing sex acts they enjoyed, and complaining about tension and back problems in conjunction with the riots and growing public opposition to the regime. One day, however, Muse even picked up a call Noriega made in the wake of an antigovernment riot. He asked a PDF captain if he was holding a certain prisoner.

When the captain replied in the affirmative, Noriega ordered him to "*sacarle la mierda*," (beat the shit out of him) and then transport him to a prison colony on the island of Coiba so that his family couldn't find him.

As they accumulated more and more information on the PDF and Noriega's abuses of power, Muse loaded it into his unsecured Apple II GS home computer. As time passed, they even began communicating directly with the PDF with radios purchased in Miami. Sometimes they impersonated the PDF dispatchers and issued bogus orders, sending troops to the wrong location and generally sowing confusion within their ranks. Other times they would call up and ridicule the PDF and harass them.

On one occasion, Muse learned that a unit of Noriega's feared riot police, the Dobermans, was positioned in front of a Budget Rent-a-Car on the Via Espana. He called a friend in the La Cresta apartment complex, which overlooked the Via Espana from a hill, and asked him to describe the scene. The friend told him they were just standing around. Armed with that information, Muse contacted the Doberman lieutenant in charge of the unit on his radio and told him to look up the hill in the direction of three apartment buildings. "I'm up here and I'm looking at you right now," Muse lied. "I've got a 30-power scope aimed right between your running lights." Muse challenged the lieutenant — "if he was brave" — to come up the hill and do something about the threat. A short time later he called his friend back and asked what the Dobermans were doing. The friend responded that they were all hiding beneath trucks and bushes.

On yet another occasion they were eavesdropping on a PDF colonel who had forgotten Noriega's private number at the Comandancia. "The number was given over the airwaves," remembers Muse, "and we intercepted it." One of the Rotarian conspirators called the number and pretended that he was Noriega's Brazilian sorcerer, Ivan Trilha, and was given the general's number at one of his hideaways. They called him there and kept on harassing him until the number was changed.

Radio Liberated

In their spare time, Muse and his confederates continued to search for new frequencies to monitor. One day Muse was scanning down in the 200kHz range and came upon a low-frequency, high fidelity music transmission that corresponded to regular radio programming elsewhere on the FM band. He couldn't figure it out. But

with a little research they discovered that it was the repeater frequency linking a radio studio to its transmission tower. Suddenly, they were seized with an idea: if they could overpower this signal wouldn't the tower transmit their broadcast instead of its regular programming? A little more research confirmed that it was not only possible, but actually quite easy.

They found out that they would need a directional antenna, transmitter and microphone. The equipment cost around \$2,000 and they all chipped in. Muse and one of the other Rotarians traveled to Miami, picked up the equipment, and smuggled it back into Panama. For their maiden broadcast they targeted Noriega's own Radio Nacional and overrode the signal during one of the general's speeches to the nation. Noriega was furious but the Panamanian government, believing their own citizens incapable of such an act, blamed the United States. It was only later, as the broadcasts became more and more



M113 APCs of 2nd Plt., Delta Co., 4th Bn., 6th Mech. Inf., 5th Inf. Div. (Mech) inside main gate to the Comandancia. Photo: J.J. Moore, courtesy Jack Finch



Kurt Muse's mugshot next to one taken nine months later of his captor, Manuel Noriega. Photo: courtesy Neil Livingstone

frequent, that Noriega and his henchmen came to the conclusion that the perpetrators were probably Panamanians.

Over time, Muse and the other Rotarian conspirators were provided with better radio transmitters, and even a television transmitter, ostensibly by an opposition group. In reality, the CIA was the source of the new equipment, although Muse was never actually told its origin. Using the new equipment, which was set up with timers in vacant apartments, the Rotarians broadcast three times a day at 91.5 on the FM dial, generally during "drive time" when traffic congestion made it more difficult for Noriega's DF (Direction Finding) teams to move around.

Noriega was outraged by the broadcasts

Noriega in happier days: courtesy Jack Finch



and Cuban teams with sophisticated direction finding equipment were brought in to locate the source of the offensive transmissions. What followed was a harrowing and potentially lethal game of cat and mouse involving the Rotarians and the DFers. When the DFers got too close, the Rotarians would shut down the transmitter and move it to another site. On at least one occasion they had to smuggle their equipment out of a building right under the noses of the PDF. On several occasions the DFers nearly caught up with them, including one time when they stormed an apartment only 20 feet away from an apartment that actually contained a transmitter.

When Muse was finally apprehended in April 1989, it was because of a tip from the wife of a man that had made one of their early recordings. Noriega had offered thousands of dollars for information on his opponents.

Arrest and Detention

On the night of 5 April 1989 Muse returned to Panama from Miami. Everything seemed routine as he pushed his passport through the opening at the immigration window. The bored-looking immigration official stamped it and passed it to his right, to a member of Panama's G2 (military intelligence) and Kurt stepped down to the next window. The G2 man began thumbing through the book in front of him. Suddenly Kurt's heart stopped: in front of him, taped to the glass window in the booth was a sign, which he read in reverse. It said, "Kurt Muse. American citizen. Arrest him on sight."

He wanted to run. Or scream. But he

Continued on page 108

FLASHPOINT LIBERIA

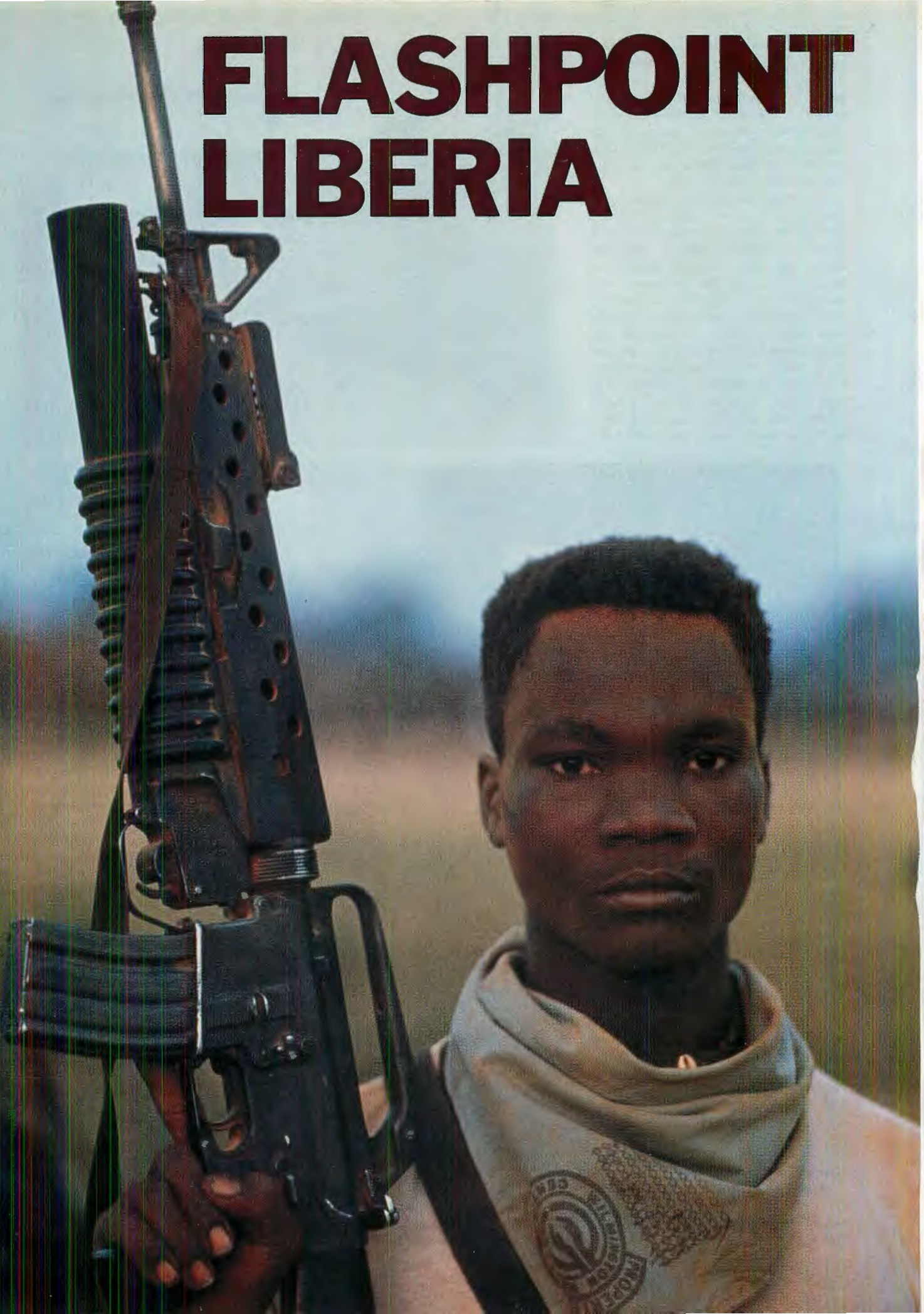

Yank Journalist Caught Up in African Revolution

by Thorn Green
Photos by Daher/Syigma

THE city crouches, looking over its shoulder, waiting. Above the intermittent rumble of army trucks and other military vehicles wafts the reoccurring drone of aircraft circling over, around, back over. The soldiers have a tattered, angry, exhausted look, and many hold dirty weapons for which they have no ammunition.

Ordinary people either move quickly along the streets on errands, looking at no one, or move not at all, their dark faces confused and fearful. All are waiting; even the sidewalks and buildings, many empty now, wait. The tropical air, burned white by the midday sun, seems to hold itself bunched and suffocating, the humidity heavy, sucking the moisture and strength out of every human being. Only the nearby Atlantic moves strongly, surely. But then, it carries, some distance offshore, a flotilla of U.S. Navy ships, with helicopters, amphibious landing craft, and over 2,000 Marines.

Another temporary truce has been called in the civil war that began in earnest the Saturday after Christmas, 1989. The civil war has been labeled an "attempted coup" by the government and "foreign mercenaries" have been blamed, along with assorted others. On that day Liberia's capital city,

Monrovia, was filled with tanks, troop carriers, soldiers and gunfire. At the end of the day, President Doe announced that the coup had been put down, and that the Liberian army had also suppressed the fighting along the eastern border of Nimba County, which lies along the borders of Côte d'Ivoire (Ivory Coast) and Guinea. Doe claimed that "many people" were killed by mercenaries.

The "mercenaries" turned out to be enraged Liberians who had previously fled the country to keep from being killed by Doe's soldiers. They had come back, led by Charles Taylor, formerly a government official for a brief time in the Doe administration. Taylor was accused of embezzling (which may or may not be true) and fled to the United States. Under the treaty and extradition agreements between the two countries, the United States had to arrest him and send him back. As they were in the process of sending him back, however, he escaped, and began gathering the Liberians together wherever he could find them, most of them being in Côte d'Ivoire.

Since many of them had been out of Liberia since the bloody, unsuccessful coup that followed the fraudulent elections in October 1985, Doe was calling them "foreign" and "mercenaries."

One soldier was reported killed during the December coup attempt, and in January Doe put the clamps on Monrovia as hard as he could, requiring people to stop for vehicle searches, putting up roadblocks to check people at various downtown locations, and keeping the army on constant patrol around town. Several persons were found dead, some beheaded, but the murderers were never found. Some of the several hundred Liberians who work as guards for the U.S. Embassy disappeared, and it was unknown whether they were killed or ran off in fear. Soldiers used tear gas to break up groups that were said to have been "rioting" downtown, and ordinary citizens were often caught in the middle of it, terrorized by gunfire that would suddenly erupt, then cease. Trying to appease the people, Doe announced that all taxes were canceled. Although this was greeted with enthusiasm by the people, it would not be effective until ratified by the legislature.

Quite a number of Peace Corps volunteers and other workers had to leave Nimba County and go to Monrovia to escape the fighting. In spite of Doe's claims to have "put down" the fighting there, it continued to escalate. Charles Taylor sent a message to Doe to be out of the country in 90 days. Doe ignored it, but was never seen anywhere without his bodyguard of Israeli-trained Krahn guards, and he started having the streets blocked off in all directions when he left the capital or his nearby mansion.

Atrocities of various types continued through February, and it was often difficult to tell who was doing what, and why. One of the serious problems in Liberia comes from the fact that there are 16 tribes, and they often contend in varying degrees with each other, even under ordinary circumstances. There are four that seem to be playing a major part in this war, however — the Krahn tribe, to which Doe and a majority of government officials belong; the Mandingo tribe, which backs Doe; and the Mano and Gio tribes, which hate the other two.

It is essentially a situation where if, say, a Mano kills a Krahn, then all Krahn tribe members go after all Mano tribe members for revenge, and they do not worry about whether the tribe member they are killing even knew about the event that precipitated the attack. All tribe members are held responsible for whatever any individual within the tribe may do. This was going on long before the war, and will go on after it.

FAR LEFT: Rebel with U.S.-supplied M16A1 with M203, captured from regime army. Roughly half of Doe's army has deserted; many turned coat and joined the rebels.

LEFT: Although starting with a disciplined cadre, Taylor's rebel forces were soon swelled by volunteers joining in response to Doe's severe countermeasures. Rebel wearing NIOSH-style dust mask probably thinks it provides strong juju.

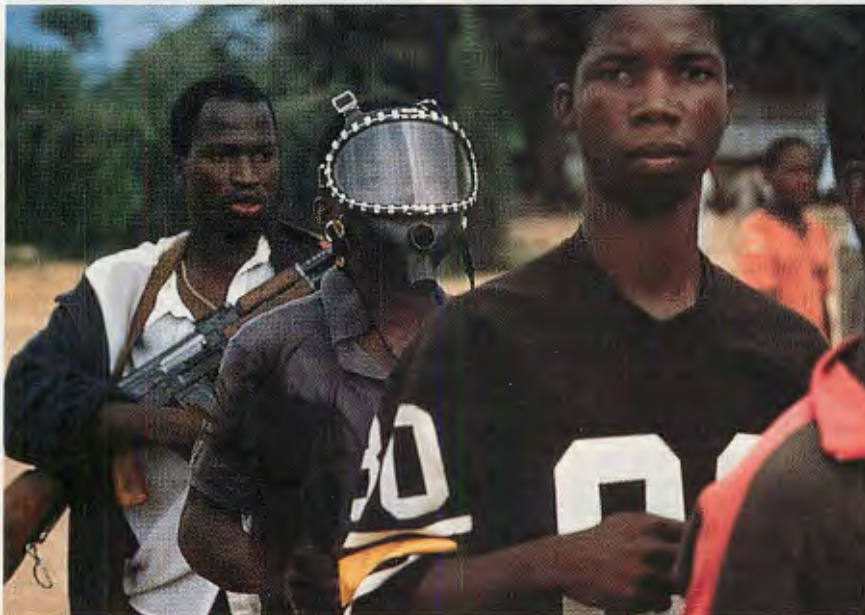



Rebel leader Charles Taylor with AK-armed rebel entourage.



Rebel soldier with grungy PPS M1943.

Many members of the Krahn tribe left the country because they fear revenge from the Mano and Gio tribes, simply for what Doe has done to the latter.

During the week of 12 March, the street was rife with rumors that a reporter from the *Daily Observer* was looking into a report that government troops had killed 200 children being taken out of Nimba County by truck. Early Saturday morning, 17 March, the *Daily Observer* was burned down. Incredibly, it put out an issue on Monday the 19th, carrying the story. In that report, the paper stated: *Two eyewitnesses even spoke of seeing the four men in military uniforms and heavily armed, and they threatened to kill anyone who would attempt to stop them from accomplishing their aim ... The watchman said the man*

told him they came purposely to destroy the building because "the Daily Observer can leak out all the people's secrets, and so the paper will no longer be able to publish anymore."

On Tuesday the 13th, journalist Klon Hinnah, managing director of the Liberia Media and Marketing Services Inc., publisher of the *NEWS*, was detained and taken to prison on the orders of Chief Justice Emmanuel Gbalazeh. The charge was "subordinating his (Gbalazeh's) opening statement at the opening of the March Term of the Supreme Court of Liberia to the remarks of Justice Minister Jenkins Scott." In other words, the story on Scott was placed before the story on Gbalazeh in the paper. The journalist was fined \$2,000 and ordered jailed until the fine was paid.

The Press Union of Liberia issued a strong statement over the burning of the *Observer* and the detention of Hinnah. On 20 March, Hinnah was released after paying \$500, and his newspaper ran the headline, "NEWS PAYS RANSOM."

There was a report from an unofficial source that the army found 29 troop boats along the St. Paul river near Monrovia on 23 March. The army, believing they might be the boats of rebels getting ready to make a strike inside Monrovia, beefed up their forces and were said to be considering a curfew.

Other sources report that a considerable number of Liberian guards for the U.S. Embassy were heard making threats (via their communications radios) to do harm to embassy employees. This was apparently because of Doe's statement earlier in the year that all taxes were canceled. As near as can be determined, the guards insisted that their superiors stop taking taxes out of their checks immediately, even though they were told that the legislature had not approved the plan at that time.

Doe recently ordered the taxes to be collected immediately, which would amount to most of their paychecks for a while. Since the guards were afraid to threaten the Liberian government, they turned on the U.S. Embassy. For several



Rebel soldiers patrol in captured army vehicle.



Taylor's NPLF rebel army claims they are receiving no outside arms — that they are using arms captured from Doe's army, who had purchased weapons from Romania last year. These rebels carry old-model AK-47s.

nights shouted threats could be heard over the radios. Eventually, one guard began calling himself "Terminator-5," and increased the graphic descriptions of the ways they intended to torture and kill embassy personnel, their families, and anyone connected with them. He then began saying they were going to burn down all the

American buildings. Late on the night of 31 March, the major warehouse belonging to the embassy was set on fire. As it was burning to the ground, with all its contents, Terminator-5 shouted, "It has begun!" Many listeners were trying to figure out what had begun, aside from the fire. The two guards who were supposed to be guarding the warehouse were arrested.

The next day, about a hundred of the guards marched on the U.S. Embassy, but were eventually calmed by the ambassador and went back to work. The situation was also somewhat defused when the Liberian National Police sent armed men around to talk to the guards on all shifts, explaining that it was their own Liberian government which had caused the situation, not the U.S. Embassy.

Liberia has become a country full of people (though not so full as it was once) without names or faces. The only two people in it who will give their names and permit photos to be taken are President Doe and Charles Taylor. The reason: no matter what anyone says, it will offend someone, and that someone is a Liberian who can see to it that you are killed, and in terrible ways. Therefore, we have plenty of "sources," but none will talk unless assured of anonymity.

About the same time as the confrontation with the embassy guard was going on, sources reported that rebels were moving closer to Monrovia and that they had rocket launchers, having used them to level several small towns. Several highly placed government officials were killed, including one who was beheaded and left in the street.

The 29 March edition of the *Daily Observer* ran headlines saying "Two Missionaries Killed In Nimba ... two Catholic Priests Feared Missing." Part of the text read, "An American embassy official said Liberian military forces have informed the embassy that missionary Thomas K. Jackson, 73, an American national, and his wife, Jane M. Jackson, a British national in her early 50s, were killed in fighting near Bahn City last Saturday."

The two priests had, in fact, been held by someone, but were later released. Following these events, the American ambassador requested that all Americans leave Nimba immediately.

By the end of March, many people were leaving the country without being told, not just Liberians. Algeria closed down its embassy completely for "economic reasons" and said they would carry on diplomatic relations with Liberia from France. Other non-essential personnel from many nations were advised to leave and did so. Part of the reason, other than what was plainly obvious, was that Charles Taylor had become almost an early morning regular on the BBC radio. He claimed he would shortly be in Monrovia and most people believed him.

President Doe was casting about for anything he could think of that might help his side of the war. He went down to the

PRINCIPAL PLAYERS

Sergeant Samuel Doe assumed control of Liberia on 12 April 1980, following a coup against the government of Liberia's 19th president, William R. Tolbert, Jr. Doe promptly suspended the constitution and imposed martial law, but promised to restore civilian rule by 1985.

Elections were held in 1985, and they were the first in Liberia based on universal suffrage, but they were engulfed in a maelstrom of controversy. Doe used his authority *inter alia* to curtail debate, limit the number of opposition parties, to detain political opponents and independent journalists and hold them incommunicado. These tactics, and the Doe government's "irregular" method of counting votes, worked. It was announced that Doe had garnered 50.9% of the votes, and his party (National Democratic Party of Liberia — NDPL) had gotten 80% of the legislative seats. The new government and new constitution were inaugurated 6 January 1986, with Doe as president. It is generally felt that the real winner of the election was Jackson Doe's Liberia Action Party (LAP).

The bitter aftermath of the elections saw Thomas Quiwonka, who had been the military chief of Doe's People's Redemption Council (PRC — the interim government after Doe's coup against Tolbert) return from exile like an avenging angel to lead a coup attempt against Doe. The coup was foiled, and some 3,000 people, including Quiwonka, were killed.

Returned exile from the Tolbert regime, U.S.-educated Charles Taylor had also been in the PRC's interim government as head of the General Services Agency, but fled to the United States when Doe's government charged him with embezzling funds — a charge that may or may not be true. In jail in Massachusetts awaiting extradition to Liberia, Taylor escaped to Libya where he underwent some years of military training.

Meanwhile, things were going from bad

to worse in Doe's Liberia. Corruption grew exponentially. A 17-man accounting team was sent from the United States in 1987 with a two-year commission to help straighten out Liberia's finances and see that as little as possible of the \$50 million a year in U.S. aid was skimmed by Doe. They came home a year later in disgust, citing "lack of cooperation from Liberian officials."

Last Christmas eve, Taylor and a handful of poorly armed rebels invaded Liberia from the Côte d'Ivoire, intent on overthrowing Doe. No one took him seriously but Doe, whose forces reacted so harshly that thousands of people in Nimba County joined the rebellion (now known as the National Patriotic Front (NPF)). Thousands have been killed, more than 150,000 have fled. Support for the NPF has been snowballing in Liberia in reaction to Doe's harsh actions, and has grown in foreign quarters when Taylor stated the years he spent training in Libya did not make him a tool of Libya and that Libya is providing no support. Although several of Doe's cadre claimed they were trained by Libyans and could speak some Arabic, Taylor claims, "We are American in terms of our philosophy on government and on economy."

Meanwhile, domestic and foreign support for Doe has been on the wane. His call for help from the United States to quell the "Libyan sponsored" uprising went unanswered. Desertions from Doe's army have cut his forces in half, leaving Doe and Taylor evenly matched. Truce talks were held, but neither of the principals attended. As we go to press, Doe is barricaded inside his mansion with his 500-man bodyguard, who vowed that they wouldn't let Doe leave without them. Doe states that he will remain until "a clear victor emerges."

Time will tell. In the meantime, stay off the streets of Monrovia. — Don McLean

Waterside district and rounded up a couple truck loads of "rogues" (thieves), had their heads shaved, and put them in the army. As soon as they finished brief training and were issued weapons, however, 90 percent of them ran off with the weapons and were soon using them in their regular business — robbing the citizens.

Likewise, his new recruits were being sent out with little training, scared and incompetent. Many were killed immediately by rebels and their weapons used to increase the rebel arsenal. Others just joined the rebels and took their weapons with them.

The former Minister of Finance, Mr. David Farhat, held a reception for U.S. Ambassador James Bishop, whose term was nearly up. He left not long afterward, and his replacement Peter De Vos, an old Africa hand, had to use a special plane to get to his post, as the international airport at Roberts Field had been blown up by rebels. Ambassador Bishop developed a contingency plan for the evacuation of the embassy in case it was needed, however,

before his departure.

Just 11 days after the reported "killing" of the missionaries, another American was killed, this time in downtown Monrovia. Martin Joseph Millay, 40, a civilian employee of Gibacol Air Services, was driving shortly after midnight when soldiers manning a checkpoint near "Our Lady of Lebanon" Catholic Church on the St. Patrick's High School campus, fired on him, striking him in the lower leg. The next morning he had surgery for removal of bullet fragments, and died of a coronary attack during the surgery. As far as is known, he had no previous history of heart disease. A government statement said that he was shot for driving through a roadblock near the executive mansion.

Doe's army recently went into the bush and slaughtered all the patients in a leper colony. They then executed 130 of their own soldiers for being members of the Gio and Mano tribes. Beheadings continue, and now include women, if they are Gio or Mano tribe members.

Numerous reports were received con-

cerning army troops being slaughtered in groups by rebel mortar fire. They were attempting to patrol roads looking for rebels, but remained in the trucks. The rebels hit them with mortar fire from concealment and all were killed. The rebels then took all the weapons they could find, further increasing their firepower. The number of troops killed in this manner is not known, but is said to be considerable.

During the week of 23 April, President Doe held a news conference, during which he stated that the press would be treated as rebels if they printed anything the government didn't approve of. The front page of the 27 April issue of the *Daily Observer* was completely blank, except for the name and date.

By the end of the first week in May, all Peace Corps volunteers had been evacuated, as well as most of the American embassy staff, leaving only about 70 people



Rebel with Romanian AKM and Soviet-style grenades. In spite of the heat and rapid decomposition, burial detail has a low priority in African wars.

at the embassy. Also, by then, the U.S. dollar was worth about three times as much as the Liberian dollar. Before the December coup, they had been about equal, (black market aside) but the U.S. dollar had begun easing upwards as the war escalated and more and more people with U.S. funds left.

There is a saying in Africa: "When elephants fight, grass feels the pain." The common people in Liberia are like the grass, and their pain is impossible for a foreigner to know. Yet, some of it shows in ways that can't be missed by a passerby. One group, for instance, is the "Charlies" or street vendors who sell African art, some of it of museum quality in the United States. Hand-carved statues made of hardwoods, some of them very large, wooden masks in all sizes, some exquisitely ornate,

brass vessels and figures — the list is, or used to be, endless. Now, the Charlies are selling anything for a pittance in U.S. dollars, just any amount to keep from abandoning their wares in the streets or in their huts. The rebels now appear to have control of the entire country, except for Monrovia, and the Charlies throw away hope for a few U.S. dollars, so they can leave the area before the bloodbath begins.

The U.S. government is making every effort to get all Americans out now, except for a skeletal staff of official personnel. The Spriggs-Payne airport in Monrovia is being used to bring in charter planes to take out anyone who wants to go. This airport is so small it can only take small "commuter-type" airplanes, but it is the last chance to fly. As we go to press the phone service has been down for a week. Mail service is essentially nonexistent.

The mail here has always been poor, and has always been subject to theft by anyone who thinks it might contain money or valuables. So, other than sending letters or

packages with people who are leaving, the last option is the "Shooters," men who run in the night, in and out of the country. They are a sort of barefoot Pony Express of the jungle shadows, but you can't get a schedule. Fax machines died with the phone system. For some time now, the government has been shutting off the electricity for several hours a day on a non-scheduled basis. Not necessarily every day, but it is a common thing to suddenly have it go off, with no way to find out how long it will be before it is back on. Those with the need to have electricity for business or official reasons have to rely on generators for use during these shutdowns, and fuel is running low even at the U.S. Embassy. There has been no water for a week, as government workers quit to join the demonstrations against Doe.

Most of the stores have closed, and food and essentials are running low. It would be a lot worse, if so many hadn't left the area, but even so, it is soon going to be a desperate situation for everyone here. The

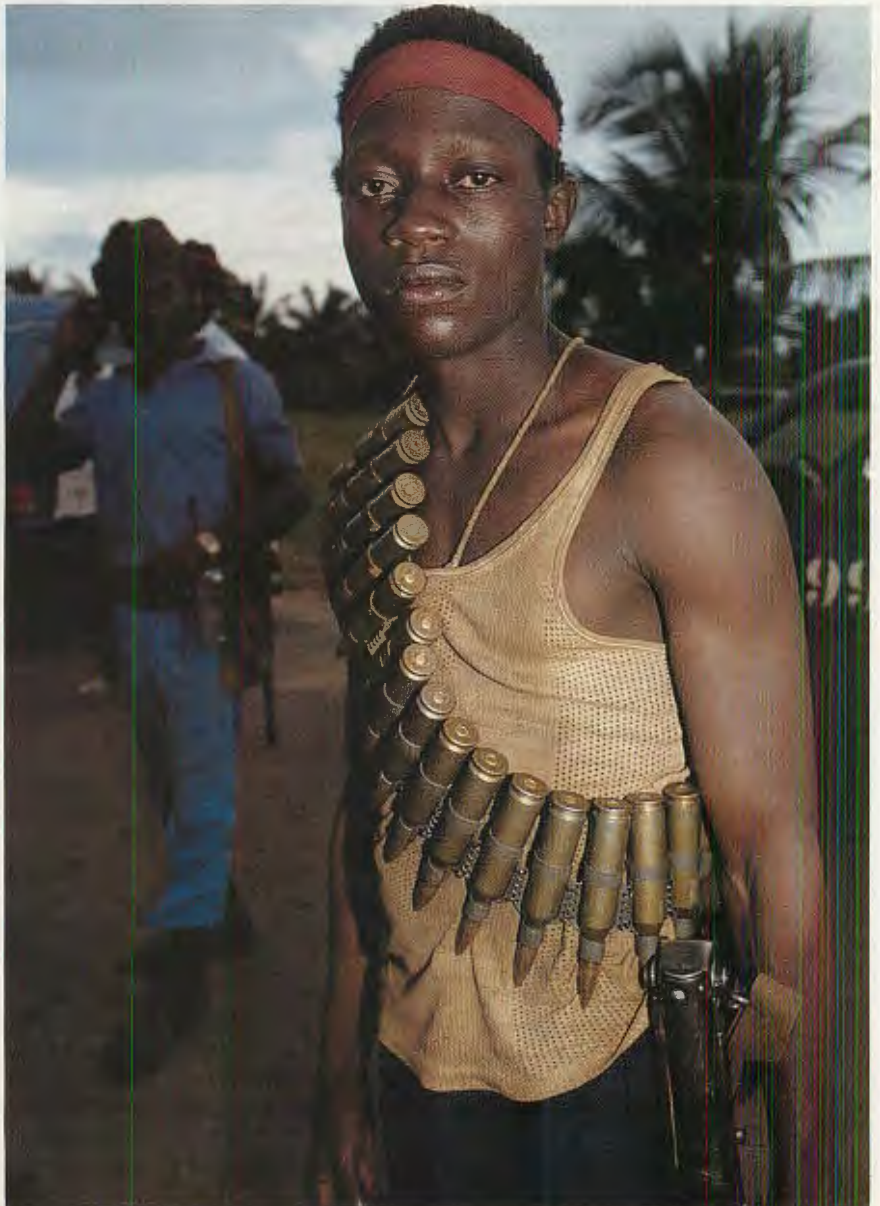

Rebel soldier carries HMG ammo and a PPS M1943 much older than he.

LIFE IN LIBERIA

Liberia is unique. Nestled in the western corbel of Africa between Sierra Leone and the Côte d'Ivoire, bounded on the northeast by Guinea and on the southwest by the Atlantic ocean, Liberia was founded on lands purchased by the U.S. Congress from native chiefs, for the resettlement of freed U.S. slaves.

The first settlers came in 1822, the Commonwealth of Liberia was founded in 1838, and in 1847 Liberia became Africa's first independent republic. Her capital was named after President James Monroe. Her form of government, constitution and flag were adapted from the United States. When founded nearly 150 years ago, her leaders were men of intelligence, vision and principle. Politically, it has been largely downhill ever since.

Although, by sub-Saharan African standards, Liberia has intermittently enjoyed one of the more productive economies, her history has been one of political corruption and internecine strife based on ethnic tribal differences. Particularly in more recent times, the current ruling class would openly discriminate against those in the general population not of the same tribe. Liberia comprises 16 distinct ethnicities, few of which get along with any of the others. General and individual conflicts based on tribal dissimilarity usually assume a Hatfields and McCoys dimension.

Liberia receives more per capita economic aid than any other sub-Saharan country. The last decade has seen \$500 million from the United States alone, and Liberia has hosted some 4,500 Peace Corps workers. Firestone Tire and Rubber maintains the world's largest rubber plantation just 30 miles east of Monrovia, as do B.F. Goodrich and Uniroyal. Her primary export is iron ore. This provides 60% of her foreign exchange, but the labor-intensive rubber industry is the largest employer. She is blessed with good resources, and an open port on the Atlantic for access to potential markets in Europe and the Americas. Her ties with the United States have always been close and significant. But so have her ties to the aboriginal past.

Voodoo plays an integral part in the beliefs of the Liberian common folk. A local tribal chief was arrested for turning into a baboon and attacking and killing people, despite his loud denials. A pig was recently incarcerated for being possessed by evil spirits. If natives don't want someone to go down a particular jungle trail, they will braid leaves or branches together as a warning — a foreigner who ignored one of these was captured by tribesmen who burned his eyes out, because they believed he had seen something he was forbidden to see.

A visitor being escorted on tour by a native driver saw a comely young native woman, walking naked along the roadway, painted white. The visitor asked the driver the reason for this, and the driver

became very agitated, saying he had seen no one, he had seen nothing. And he refused to talk to the visitor the rest of the tour. The foreigner was later told that the girl was undergoing a rite of passage into womanhood, which included a clitorectomy along with the white paint and other rituals. No one but the tribe she belonged to could "see" her. She was an "invisible woman."

Under traditional law in Liberia, an individual who has a conflict with someone may be ordered to appear at a Ju-Ju tribal truth ceremony called a "Sassywood Trial." This is most often the case when one person feels another has given him a "bad name" for no reason.

At such a trial, the witch doctor has all the participants either drink a poison or allow a red-hot sword to be placed on his/her leg. If a person is telling the truth, the poison will not harm him nor the sword burn him. Conversely, if he is lying he is made very sick or dies or is scarred for life. Some locals claim it works, but an outsider would be in big trouble if it didn't. The advice is to not do it. This practice is, in theory, now illegal under the "democratic" government, but the government sometimes orders it, and grants permits for it upon request.

Such facets of life in Liberia draw one toward the conclusion that the republican political structure, the 20th-century technology, the infrastructure of commerce, and the trappings of civilization are at times only a thin veneer overlying a stunted tribal society that today is largely the same as it has been for centuries, with modern ideas and institutions living only in mimicry.

The 12th of February is Armed Forces Day. There are no family picnics, cold beer and fireworks. In Monrovia the people on the streets give the armed soldiers money, out of "appreciation." Many of the soldier are drunk, and it is wise to follow the local custom — or hope up like the Americans and other foreigners do. This year when automatic weapons fire was heard one did not know if it was a soldier celebrating, shooting someone, or perhaps one of Taylor's rebels on a hit-and-run mission.

While Doe waits, the country waits. And the tenuous infrastructure crumbles. People are slaughtered in Nimba county and elsewhere and thousands of others flee, while many others die of Malaria, dysentery, and the traditional infectious diseases that have always plagued Africa.

Both warring political factions wish to protect foreigners because of the money they get from them, up to and including World Bank loans. But the overriding fear of foreigners is that the situation will deteriorate into anarchy, in which uncontrolled and possibly even unallied individuals might just start berserkly shooting, looting and burning.

— Thorn Green and Don McLean

foreigners who remain took care to stock up long ago, but there is a limit to all supplies, even if they are not destroyed or stolen by one or both parties in the conflict here.

And the terror in Monrovia continues. This morning three bodies were put on display at the JFK Memorial Hospital morgue. Their bodies were in one place, their heads in another. The hands had been tied behind the backs and remained so. Police said they put the heads on display so the dead could "be identified." As usual, there are no suspects, but it is believed to have been the work of the Liberian army. They had been horribly tortured, as marks on their bodies witness. A fourth man was said to have been found in a different place, his genitals cut off.

The vice president has been placed under house arrest after he suggested to Doe that he step down, while they were meeting with some legislators. Reports say that Doe then slapped him, he slapped Doe, and Doe then kicked him, after which they were pulled apart. His fate seems tenuous, at best.

The army hires a few bush pilots to fly ammunition to them, and yesterday one barely made it back to Monrovia, with a chunk shot out of his aircraft's tail.

The local airport is now closed, and some foreigners were evacuated to Freetown, Sierra Leone, by ground caravan, so they could catch planes to anywhere. That pretty well wraps it up for foreigners leaving. Some have chosen to stay, most of whom have lived in various parts of Africa for a long time and feel they are safe from the Liberians.

The ships standing off the coast are only for the evacuation of American embassy personnel and any other American officials remaining here, if it becomes necessary.

The "peace-talks" that led to the present cease-fire were not attended by Doe or Taylor, and both have said they will attend no talks, but will continue sending representatives. They have both agreed to allow food and medical supplies to be brought in and taken to where they are most needed, with the stipulation that they be allowed to inspect everything first.

The people do not believe the "truce" will last. The sense here in Monrovia, with the rebels surrounding it and closing in, is that of a cobra's prey, paralyzed in fear, waiting for the strike of that great poisonous killer, war, that runs through the heart and mind before it finishes the job.

Thousands of people marched on the capital, calling for Doe to step down and avoid the bloodbath, and the next day marched on the U.S. Embassy, calling for *somebody* to do something. Taylor gave Doe and his party a week to leave the mansion. A deal was worked out whereby Doe and his people would be given sanctuary in the United States. But Doe remained steadfast behind doors barred by the "Satue," his crack set of troops.

Continued on page 144

OUTLAW JUMPERS

"The Moment" of Living Dangerously

Text & Photos by Peter Douglas



I FELT sick as a pig. It seemed the odds of landing on dry land were, at best, slim. With weak knees I mounted the railing. I could hardly believe I was about to leap off a bridge. Deep down I was by now convinced that I wouldn't! I balanced on the edge of the precipice for a few seconds: a small eternity. I took a deep breath and, from nowhere, a feeling of great calm came over me and I knew I would jump. Suddenly I threw myself from the railing before I could change my mind.

Three potential landing sites awaited me: one next to a main road, where I could be hit by a car; two, next to railroad tracks, where I could be hit by a train; three, in the river, where I could drown! It was my first BASE jump and, being used to a minimum parachuting altitude of 2,500 feet, it looked very low.

I wasn't the first to take the plunge today. The first jumper hauled himself up onto the railings and without a second's pause threw himself from the bridge. The rest of us flinched involuntarily, then craned forward to watch the lead jumper fall away. His parachute streamed out from the backpack and snapped open with a roar of wind-whipped nylon as it caught the air and inflated.

Soon our horribly cheerful dispatcher barked out "Next," and the next jumper, wishing to get this over as fast as possible, bounded up onto the railings and didn't so much as leap off as step off. He plummeted straight down and vanished underneath the bridge. His parachute swerved violently to the left before turning back toward the river bank. It seemed obvious that he wasn't going to make it to dry land. He let out a string of abusive oratory before plunging into the dark waters. The previous jumper had by now been safely hauled in and was crawling up the river bank. As soon as he was safe the words I was dreading were called: "Next!"

Off I went.

Arms thrust forward for balance, eyes fixed on the water below,

for a split second nothing seemed to happen and then the river raced up toward me in a blur of motion. In that same second the parachute opened and I grabbed the right-hand steering toggle and hauled it down past my kneecaps in a desperate bid to face the parachute toward the footpath. This reflex action was so sudden that the canopy turned violently and pointed straight toward the stone support-pillar of the bridge. Wide-eyed with alarm, I had just time to effect a dramatic turn to the left, flash past the stone support and clip the branches of a small tree, before pulling down on both steering toggles, which act as brakes. The canopy stalled and I impacted on terra firma with a resounding thump, much surprised as I could see the footpath still 30 feet below me.

I had landed on a 6-foot concrete ledge above the entrance to a railroad tunnel. The other two jumpers were by now loping away along the footpath, toward a car parked some 300 meters further on. My predicament was unsettling, the only way down seemed to be a slide down an ice-encrusted concrete column, which sloped down to the footpath. To delay was to invite apprehension by the "Base Patrol," to slide seemed to invite broken limbs. With more bravado than common sense I sat on the column and slithered down with alarming speed. At the base I was thrown onto the path in an undignified heap at the feet of the first man to jump. He was scooping up his parachute and advised me to pick myself up and run like blazes if I wanted to effect a good escape.

Needing no further encouragement I leapt to my feet and hastened after my departing comrades. The escape car was ready with its engine revving as we, with three sopping wet parachutes, dived in and covered ourselves in warm dry blankets. A clean getaway, an essential part of a successful BASE jump, had been effected.

BASE is an acronym for Building, Aerial (TV transmitter tower), Span (Bridge) & Earth (Cliff). Each represents a fixed object from which a BASE jumper must make a parachute descent in order to qualify as a full-fledged member of BASE. The structures must be of sufficient height to be non-survivable if made without the aid of a parachute.

In sport-parachuting altitude is sacrosanct — "Ignore not your altitude or the ground shall rise up and smite thee dead." BASE jumpers also desire the safety afforded by altitude but, due to limitations of fixed object jumping, seldom find it.

BASE began as a sport in the USA, home to some of the world's tallest structures, as well as natural, almost vertical, cliffs, thousands of feet tall.

Early BASE jumps were from structures tall enough for freefall. However, when the BASE bug hit Britain in 1982 there was a severe shortage of suitable structures. By contemporary estimates there were not sites of sufficient height. This led to a radical solution, static line descents with Ram Air parachutes, allowing objects to be

BUILDING ...

Balanced precariously on the narrow wall ... the whole of London seemed spread before my feet. Almost without realizing it, I threw myself from the wall ... I distinctly heard the roar of nylon as the parachute filled and inflated. Reaching for the steering toggles, I instantly put on full brakes in order not to overshoot into the canal, letting them up at the last moment to surge forward and flare the canopy for a stand-up landing ...

jumped that had previously been thought impossibly low, indeed non-survivable.

While technically no laws are transgressed in Britain in making BASE jumps (providing no damage is caused in gaining entry to the site), such jumps are seriously frowned upon by authority. Jumpers can expect hours of explanation and hassle if apprehended, and even temporary confiscation of parachutes. Added to this in 1982 was the negative attitude adopted by the governing body of sport-parachuting in Britain, which threatened life bans on any sport parachutists BASE jumping.

These two factors, coupled with the unforgiving nature of the sport, ensured that high standards of planning and preparation were maintained by BASE jumpers in what became for all intents and purposes an "underground" sport conducted in great secrecy, with non-detection and clean getaways essential for a truly successful BASE jump.

Span

The first BASE jumps in England were from the easiest of all BASE objects, a bridge (Span). While the jump itself is easier from a bridge (having jumped you are immediately clear of dangerous obstructions) landings can be more of a problem. As bridges normally exist for the very purpose of crossing over such inconvenient obstacles as rivers and rocky gorges, a bridge of suitable altitude, with an acceptable landing site, can be hard to find.

The most jumped bridge in England crosses a fast-flowing river and is only 245 feet high. Its main drawbacks are a wide river below with a busy road on one bank and a railroad on the other.

I made a BASE jump there in the winter of 1982. Since the first BASE jumps were made off this bridge in 1982 it has remained the most popular BASE site in Britain.

Earth

A cliff (Earth) jump is required to qualify for BASE. Sadly those available in Britain are humble fare. More dangerous than bridges, due to the danger of contact with the cliff face (described by some as "jumping by Braille"), which collapses your parachute. They do however have the advantage of normally being sited in remote locations with little risk of detection.

The best cliffs are those that face out to sea, providing there is a suitable beach to land on. I was fortunate enough to be present during the first cliff jumps in England. Careful reconnaissance had been made to locate a suitable cliff. One of 500 feet was rejected, as the landing site was strewn with large boulders and thought too hazardous. A year later, other less safety conscious BASE jumpers attempted it, and suffered limb fractures on landing.

The cliff we chose offered a 280-foot vertical drop onto a flat pebble beach. It was also isolated and therefore free from casual or official observation. On a bright sunny day, with a moderate breeze blowing out to sea, and *not into the cliff*, our group of BASE



jumpers set off to "jump rock."

The cliff face began, not vertically but as a graduated curve, becoming increasingly vertical. The major question on everyone's minds was whether one could launch with sufficient vigor to clear the curvature of the cliff. We paced up and down looking for the perfect launch point. There was much debate. Rocks were thrown

AERIAL ...

There is nothing so lonesome as being right on the edge of a sheer drop just before a BASE jump ... With a sharp intake of breath I braced, and dived from the platform. The canopy opened fast and clean. I released the steering toggles and made a straight glide ... A wave of adrenaline washed over me as I turned to see my companion leaping clear of the tower ...

over the edge and ears strained to hear if they fell free of the cliff or ricocheted their way down. Those that cleared the cliff were applauded with optimistic comments, but others made distressingly loud contact with the cliff-face.

Possible launch points were narrowed down to one. More rocks were thrown. More consultation. Finally, running out of loose rocks, a general agreement was reached that, in theory, it was feasible. To test the theory someone would have to jump and hope not to meet the cliff on the way down. Much muttering, head-nodding, and general positive comments were expressed without actually addressing the crucial question of *who* was going to be first! One of us eventually declared that he would go for it and the rest heaved a collective sigh of relief, and, with disgraceful speed, helped him into his parachute harness in case he changed his mind.

With the decision to jump made, and the static line firmly secured, the jumper was carefully checked out. The launch point was on a short spur that jutted out from the rest of the cliff line. The jumper paced out the run up, to ensure he would have a clean launch. The rest of the group double-checked the static line and then backed off to positions that offered a clear view, and gave the jumper a few seconds of quiet contemplation as he psyched up for the jump.

He stood still, staring intently at the cliff edge a few feet in front and then up toward the horizon, fixing the launch point in his mind's eye. He practiced the arched launch position, remembering to throw his head well back to look above the horizon, there being a tendency for the body to follow the direction of the eye line at the point of launch.

When standing on the cliff top you had an exaggerated impression of height as the view out to sea offered nothing with which to gauge scale. After a minute the jumper took a deep breath and surged forward with total commitment. With three long strides he reached the cliff edge and hurled himself off, arms stretched forward reaching for the horizon, head tight back. A perfect BASE launch.

The onlookers tensed as the jumper arched out from the cliff, the static line braced taunt as the parachute snaked out of its pack and the jumper began to plunge toward the beach 280 feet below. A mesh of nylon parachute guide lines stretched straight above the falling jumper before the canopy snapped open just as the 100 pound break ties, which attached the canopy to the static line, broke. The Ram Air parachute deployed perfectly as the jumper reached up and hauled hard down on both steering toggles to speed deployment. A triumphant yell went up from those lining the cliff top.

He glided over the sea, made a sharp right turn back toward the beach and executed a perfect stand-up landing. The first BASE jump from a cliff in Britain was a success.

Buildings

Buildings are a bitch. Few are of acceptable height and entry to those that are is often restricted. Finding a suitable building in Britain involved visits to many potential sites that drew blanks. To remain within the law, there could be no question of forced entry. Finally a site was located in London, a building of 270 feet.

It was the second tallest apartment block in Britain, it also had a tight, but acceptable, grass landing site on one side. There was plenty of incentive for an accurate landing as overshooting would



SPAN ...

I threw myself from the railing before I could change my mind ... Arms thrust forward for balance, eyes fixed on the water below, for a split second nothing seemed to happen and then the river raced up towards me in a blur of motion. In that same second the parachute opened ...

mean dunking in a canal that ran along beyond the patch of grass. Wind-speed and direction would have to be just right for a jump to be possible.

A close reconnaissance was called for. The exit point would have to be off the tallest part of the roof, above the lift shaft. Buoyant with suppressed excitement, we casually sauntered across the lobby and into the lift. The lift stopped three flights of stairs short of the rooftop, entry being via a caretaker's door. With no one about we slipped through this door and cautiously walked up two flights before being stopped by a padlocked iron gate. Bitter disappointment all around was not helped by the fact that the door onto the roof was in sight, tantalizingly close at the top of the last flight of stairs.

Forced entry was out of the question. There was no alternative but to be patient. One jumper was to check the padlock after working hours each day. We struck lucky on the second day; the chain was wrapped around the padlock in place but it was not locked. At first it was assumed that the caretaker was working late. A return visit was made two hours later to check the padlock. It was still unlocked.

In the early hours of the following morning, after a sleepless night, our van pulled up outside. My finger tips tingled with nervous excitement as we approached the iron gate. It was still unlocked. The jump was on. A few quick steps and we were through the gate, up the stairs and onto the roof, riding high on a mixture of adrenaline and fear.

The rooftop was surrounded by 10-foot concrete walls. Once up on top we found it to be distressingly narrow, so that our toes and heels were free of the brickwork. There was also a lot of visual feedback from other buildings and cars parked below, not encountered on BASE jumps from other objects. This had the effect of reminding you, in a horribly clear way, just how low you were.

Balanced precariously on the narrow wall, with one hand holding onto a thin metal pole that jutted out from the corner, the whole of London seemed spread before my feet. Almost without realizing it, I threw myself from the wall, forcing every muscle into a spreadeagled position.

In the still air of early morning, I distinctly heard the roar of nylon as the parachute filled and inflated. Reaching for the steering toggles, I instantly put on full brakes in order not to overshoot into the canal, letting them up at the last moment to surge forward and flare the canopy for a stand-up landing. I turned just in time to see another launch from the corner of the building. Snap, canopy open. Stall, surge forward and flare for landing. As soon as he touched down I bolted for the parked van. The rear doors were thrown open by a support team member and I dived in; the next jumper was hot on my heels. When he arrived we slammed the doors and the van pulled away. Hot dive! Euphoria.

The buzz of a successful BASE dive off a building is, I think, the best of any of the four objects. Not least because they are the hardest sites to locate, dive and get away from, but also because they offer the most frightening visual experience, with all that ground feedback screaming loudly in your head.

This building was the most popular site. Later someone discovered that keys from the make of the padlock used to secure the iron gate fitted all others of the same type. The question of legality of entry was hotly disputed between BASE members but was never



EARTH ...

He stood still, staring intently at the cliff edge a few feet in front and then up towards the horizon, fixing the launch point in his mind's eye ... With three long strides he reached the cliff edge and hurled himself off, arms stretched forward reaching for the horizon, head tight back. A perfect BASE launch ... The onlookers tensed as the jumper arched out from the cliff, the static line braced taut as the parachute snaked out of its pack and the jumper began to plunge toward the beach 280 feet below ...

put to the test and the site was abandoned after the death of another BASE jumper who broke a golden rule of BASE and failed to have a pre-jump equipment check, which may have revealed that his static line was only tucked into his pack and not tied to his canopy. There is absolutely no room for error in BASE jumping. Error is death.

The tallest building in Britain has been BASE jumped at least once. Due to the secretive nature of the sport, accurate records are almost impossible to establish. However the experience of the first man to BASE this building may have been enough to deter all others.

Security was tight and vigilant. After many months of repeated reconnaissance an open door was discovered up the rear fire escape. It led straight up to the roof. The opportunity was too good to miss.

He was soon on the roof and kitted up for a jump he was sure would be a once in a lifetime experience (in retrospect I'm sure he hopes this is the case). Standing on the edge of the 300-foot drop he pushed off into a clean BASE position and had a fast opening. Unfortunately, however, to his shock and dismay, he realized that the canopy had opened with a twist, which turned the parachute straight toward the building.

He impacted with the solid concrete wall and the canopy collapsed and fell away. Fifty feet down the canopy caught enough air to re-inflate and surged forward back into the building. It collapsed a second time and he fell again. Unbelievably it re-inflated a third time and much to his distress flew straight back into the building. This time he smashed into the building by a set of railings on a balcony. Desperately he grasped at these and secured a firm grip. The canopy collapsed and draped itself over him, rigging lines tangling like spaghetti around his flaying limbs. He screamed for help. None came.

Shrouded in the canopy, hanging 200 feet up, he knew the next fall would unquestionably be his last. He realized he could not hang on indefinitely and had to struggle free of the parachute sufficiently to attempt to climb over the balcony. This meant hanging on with one hand, not an enviable situation. With strength born of desperation he managed it without falling.

Now, untangled somewhat from the constraints of the parachute, but still dangling from the railings, he found himself staring into a living room at floor-level. Seated inside, with their backs to him, was a family watching television with the volume blaring. Several more screams for help went unnoticed. Things were bad and getting worse as his strength began to fail. A shaggy dog shuffled to the window and gazed quizzically at him, refusing to bark. Hardly believing that he would be able to haul himself up and still

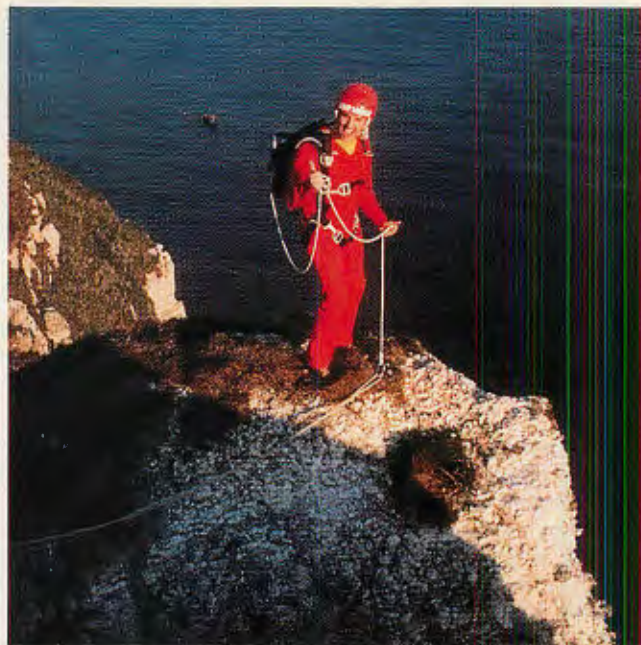

encumbered by the parachute, he gave it a try (given the consequences of failure, he had plenty of incentive). To his own amazement he made it onto the balcony.

Still hoping for a clean "getaway," he jettisoned his parachute by the quick release capewells. The only way out of this mess was to pass straight through the private front-room of the Soap-watching family. As this raised a question of illegal entry and possible repercussions, he knew he had to move quickly. He stared past the shaggy dog and the insensible family and saw two possible doors to go for, only one of which lead to the outside corridor and freedom.

He chose a door, threw the glass balcony doors wide open, bolted past the dog, hauled the door of his choice wide open and stared into a kitchen. Spinning on his heels, past the family, glued to their chairs with astonishment, he lunged for the second door, burst into the corridor and ran for the stairwell never, ever, to return to the scene of his worst nightmare.

Aerial

TV towers (Aerial) offer greater altitude but similar difficulties of access as buildings. They are generally surrounded by high barbed-wire fences and frequently manned by security staff. The jump itself also has unique hazards. The towers are tethered for stability to heavy-duty wire hawsers running from each corner. If a parachute turns on opening there is a real danger of colliding with a wire hawser, collapsing the canopy and falling several hundred feet to your death.

The day of my first tower jump was spent in checking and rechecking the equipment. In the late afternoon we made a last daylight reconnaissance close to the tower, under the pretext of walking dogs. The weather held and in the early hours of the morning we crept up to the wire fence surrounding the compound. Support team members braced themselves against the fence to enable myself and one other jumper to climb up and have, from their shoulders, only a short section of fence to step over.

A light shone out of the building in which security personnel might be present. We were worried in case there were security dogs and wasted no time in crossing the compound to the base of the tower. With a 600-foot vertical climb up a ladder we took the precaution of wearing leather gloves, the ladder rungs being extremely cold at such an hour.

There are two ways of climbing a vertical ladder. Most people use their arms hand-over-hand to pull themselves up. On a long climb, the arms are soon exhausted, with a danger of muscles seizing up. A more effective technique for making such a climb is to use your legs to push your way up the ladder rather than arm muscles to drag yourself up. Either way it is a tiring climb and requires frequent halts. At first these were made at each staging platform, set every hundred feet. However, we began to tire and needed to rest more frequently while clinging to the ladder. This had also been foreseen and we wore a nylon harness with a strop and carabiner attached to clip ourselves to the ladder, allowing a slightly more relaxed rest.

Each staging platform was gained by squirming through a tight fitting hatchway. We therefore had to check each others' parachute packs to ensure that they were still securely closed and that the parachute had not been snagged or ripped. Had the packs burst open the breeze might have inflated them and dragged us into the central core of the metal framed tower.

The climb took approximately an hour and a half to complete, the reward for which was a one hour wait for dawn, soaked in sweat and exposed to a chilling breeze. After dawn the support team appeared in the field below and laid out luminescent air panels to indicate the ground wind direction. We threw a weighted length of crepe paper, called a "streamer," which drifted down the upper wind line. This is essential in order to gauge the correct flight path to follow under deployed parachutes.

This being the early days of low level BASE jumping we attached static lines for the jump. Later, with more experience, 600 feet would be considered easily freefallable using giant 52-inch pilot chutes specifically designed for BASE freefall.

Having secured the static line the next phase was stomach-churning as you had to climb over the metal safety bars, forced by the width of the parachute to lean out over the 600-foot drop with arms tucked behind clutching the bar. Looking directly out from the

B.A.S.E. in the U.S.A.

Large-scale BASE jumping got its start in the United States in 1980 when a group of parachutists jumped off El Capitan in Yosemite National Park. Shortly thereafter jumpers began forming groups, publishing articles and establishing a national organization. The U.S. BASE Association was founded in 1981.

Jean Boenish, whose husband founded the association, is currently executive director. What's odd about this organization is that they don't actively seek members. According to Boenish, "We try to take the most responsible approach to meeting the recreational needs of the individual and the environment. Most of our members want to pursue it (BASE jumping) in a very individualistic way and don't want a rigid organization. Also, most have a very solid background in jumping from aircraft. If not, we steer them away from BASE."

One standard they've adopted is a sequential numbering system for those who've jumped the four required obstacles. BASE jumping pioneer Phil Smith holds the coveted number 1, while Boenish holds number 3. At press time the latest qualifier received the number 281. The U.S. Parachuting Association, unlike their British counterparts, does not enforce any sanctions against jumpers who participate in BASE.

"The sport has grown steadily since 1980 and as the technology increases, membership should likewise increase," according to Andy Calistrat, editor of *BASE Gazette*, a publication for the BASE community. BASE jumping's public awareness peaked in the mid-80s as jumpers enjoyed the publicity and often made jumps in large metro areas in daylight, having alerted local media. This generally resulted in jumper arrests and subsequent fines and battles with the legal system. Today clandestine jumps are the rule and few jumpers purposely seek publicity.

That's not to say that BASE jumping is illegal per se. When jumpers get caught they're usually charged with whatever the police can think of to hang on them. Calistrat told me, "I've been charged with reckless endangerment, disturbing the peace, being a public nuisance and even invasion of privacy (landed in some lady's back yard). But the most common charges are criminal trespass and reckless endangerment."

There are several places in the world where BASE jumping has specifically been outlawed. The first was the Royal Gorge Bridge in Canon City, Colorado, later came a San Antonio, Texas, office tower called the Tower of the Americas. It's 500 feet high and offers easy rooftop access so its appeal to BASE jumpers is obvious. Jumping from either of these is a Class C misdemeanor. Auburn Bridge in northern California and Trollveggen cliff in central west Norway are also on the specifically prohibited list.

On the other end of the spectrum there's West Virginia's New River Gorge Bridge, near Fayetteville, which has BASE jumping as part of its annual Bridge Day festival. The festival is generally the third Saturday of October and has been growing each year with an average of 300 jumpers, from seven to 10 countries now participating. Fayetteville apparently enjoys the economic benefits it receives from the nearly 250,000 spectators who come to watch.

Calistrat and Boenish both estimate the total number of currently active BASE jumpers in the U.S. at 100-200 but venture to say that worldwide upwards of 4,000 have met at least one of the requirements.

Two main publications serve the BASE community: *The Fixed Object Journal*, Box 195, Oceanside, CA 92049-0195 (sample issue \$5, yearly sub \$20) and *BASE Gazette*, 3202 LaQuinta Drive, Missouri City, TX 77459 (Sample issue \$4, yearly sub \$12). The U.S. BASE Association also publishes a newsletter — *The BASE Monitor* — irregularly and should be contacted for further information on BASE jumping at 12619 S. Manor Dr., Hawthorne, CA 90250.

— Tom Slizewski

tower knowing you were about to jump was horrible, looking down was worse. For a clean deployment you had to fall stable. This meant a good positive push-off on launch with head well back

Continued on page 114

NO HONOR AMONG MERCES

Deceit, Treachery and Death in the Jungle of Suriname

by Peter Douglas

Photos courtesy the author

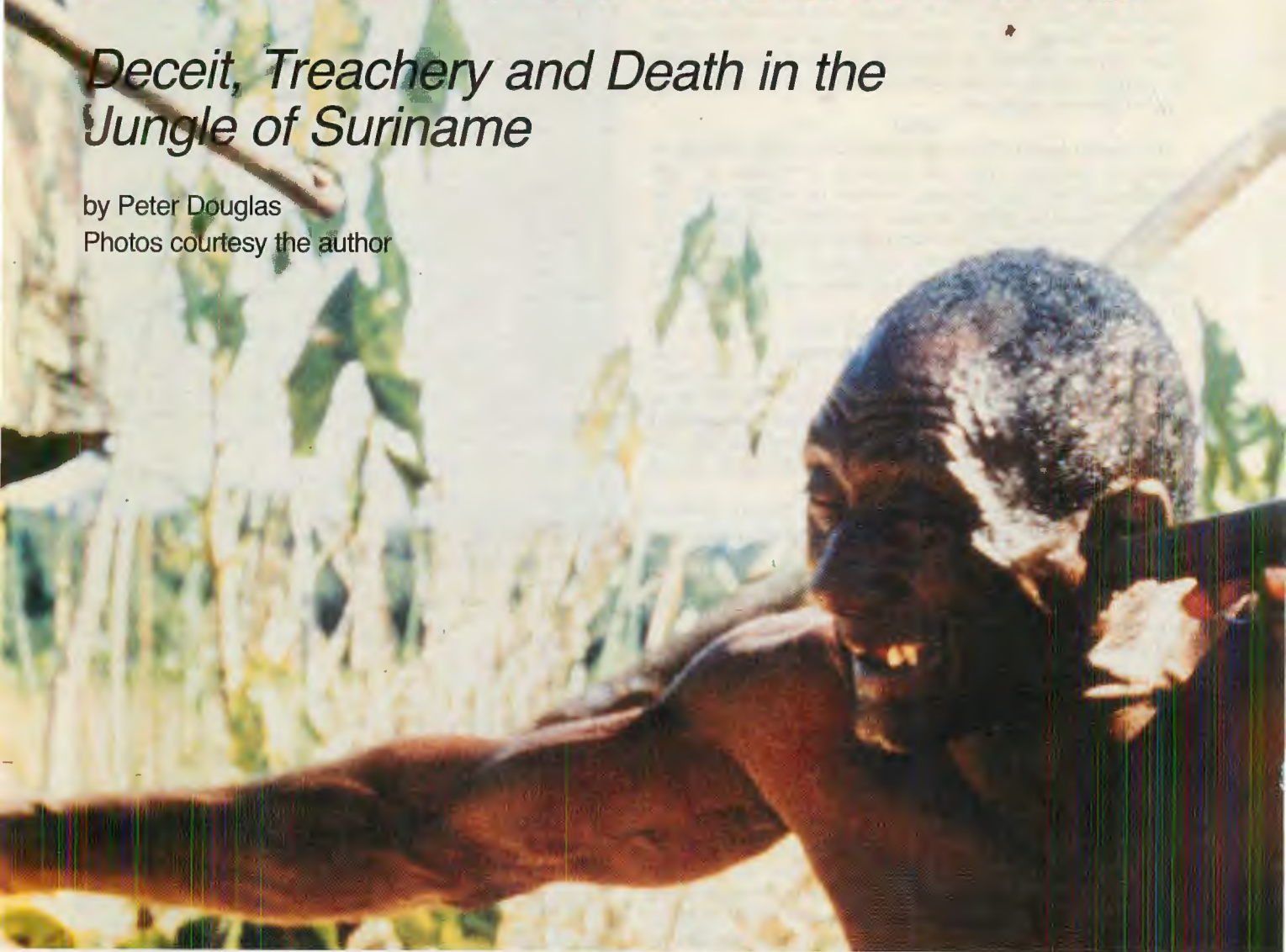

For various (and obvious) reasons, names of the mercs in this story have been changed — with the exception of John Richards, who now probably doesn't give a damn one way or another.

THE night was hot and balmy, the tropical air heavy with the fetid smell of rotting vegetation. The quayside was deserted when a van drove up and a mixed bag of six mercenaries and two journalists climbed out, unloaded their backpacks and padded across to the quayside. There below, silently waiting for them in the shadows, were two men in a dugout canoe. Edward, a tracker for the Jungle Commandos, whom they were on their way to meet, quickly helped them load their packs. The

second man was a Surinamese Bush Negro smuggler, sympathetic to the Jungle Commandos and the fee they were paying. He sat in silence, ready to ferry the group across the wide Marowijne (Maroni) River, which forms the international border between French Guiana and Suriname.

Everyone was keen to get going; there had been enough waiting around already. The quayside was in St. Laurent, French Guiana, and gendarmes patrolled frequently. With the dugout loaded, the boatman pushed off from the quay and started the small outboard. It sputtered into life, and in the still night, seemed to make enough noise to wake the dead. Relieved to be away, the men watched St. Laurent recede into the distance as the boatman

steered out to midstream before heading upriver.

The lights of Albina, an army post on the Suriname side, sparkled from the dark band that marked the far shore. A gunboat with twin .50 Browning HMGs was stationed there. Reputed to be anchored at midstream each night, the bored crew was doubtless drinking warm beer to pass the long hours — but you could never be sure!

Putting along in the dugout was pleasantly cooling and blissfully mosquito-free. The boatman cut the outboard and drifted, listening for any sound of the gunboat. Hearing nothing, he turned the dugout toward the Suriname shoreline. A searchlight in St. Laurent was dancing across the water, its restless beam randomly stabbing



the darkness. The eyes of everyone in the dugout were riveted on the beam of light swinging out across the river. They knew if the beam chanced to touch on their dugout, their presence would be betrayed to the gunboat.

For the most part, the searchlight swept the distant shadows of the far shoreline. Suddenly, the beam swung around, probing toward their position. Edward, the tracker, hissed for everyone to lie down. The boatman cut the outboard again. The searchlight cut across the water, seeming to stop right on them. "Shit," muttered one of the men. This was not good news. Armed with slide-action Mossberg shotguns legally purchased across the counter in French Guiana, nobody felt ready to tackle

the gunboat with its .50 cal. Brownings. A sick feeling of helplessness overtook them. Finally, the searchlight lifted and moved on, the night remaining perfectly quiet except for the gentle lap of water against their dugout. The men breathed again—they were probably too far out for the searchlight crew to spot such a low profile. Nonetheless, everyone was now very keen to reach terra firma.

The boatman started up the outboard and continued to edge toward the far bank. Almost there, he cut the outboard to drift again, listening for suspicious sounds before paddling the last few yards. Around midnight, with a soft bump, the dugout hit the shore. Everyone leapt out at once, glad to be back on solid ground.

Information-gathering session. No quarter is asked — or given — by any of the opposing factions.

John Richards, the mercenary who recruited them in England, appeared more at ease than the others. He had been in Suriname before. Like two others on the trip, he was ex-French Foreign Legion (2nd REP). He casually lit a cigarette, illuminating the dark jungle with the flare of his match. This cavalier attitude, at such a potentially dangerous point, did not go unnoticed by Finny and Alan, who were beginning to entertain some serious doubts about Richards.

Both Finny and Alan had served in the British Royal Marine Commandos and then

signed on with the British Parachute Regiment. They had Falklands and Northern Ireland experience between them, and prided themselves on being professional soldiers. The work in Suriname had come about when a friend, who knew that Richards was recruiting, put them in touch. They had accepted the contract in a spirit of adventure, but had niggling doubts about Richards' ability to command or lead a mercenary operation.

The contract was to work with Bush Negroes fighting a very low-key guerrilla war against the military dictatorship of Desi Bouterse, a one-time Suriname army NCO. The Bush Negroes are led by Ronny Brunswijk, a former bodyguard of Desi Bouterse. They operate as members of the Suriname National Liberation Army (SNLA). Also used is the more colorful title of "Jungle Commando," a name that endows them with an image of professional competence not necessarily matched by the facts.

Whilst recruiting in England, Richards told Finny and Alan that there would be no command structure within the mercenary group. Each man was to hold equal rank and be in charge of training a troop of Jungle Commandos in basic military skills. Realizing that to be effective a military force must have a chain of command, the two men were not impressed with Richards' dismissal of the idea as bull. Although accepting the work, Finny and Alan made a pact between themselves to watch out for one another.

The rest of the team was met at a brief stopover in Paris, before flying off to French Guiana. Like Richards, Liam was British and ex-Foreign Legion (2nd REP). Sven was Norwegian with the same credentials. Pat was a Brit who claimed, a bit too loudly, to be ex-SAS. Then there was Bill, another Brit, again ex-Foreign Legion (2nd REP), and the only one with whom Finny and Alan felt at ease. Even at the first meeting in Paris, a subtle split into two camps had begun. The Legion's ex-2nd REP camp was composed of Richards, Liam and Sven. Finny and Alan formed the ex-Marine faction into which Bill, with his calm, confident manner, easily slotted. This left Pat, with his claimed SAS credentials, sitting in the middle. Uncomfortable there, he quickly joined the more boisterous ex-Legion camp.

Sitting on the periphery of both camps were the two journalists whom Richards had allowed to accompany the group. Unaware of the split that had formed, they were anxious to be considered a part of the whole team, and bought generous rounds of drinks for everyone. The Legion camp courted them with loud and outrageous tales of past exploits, enjoying the attention.

Now, in the Suriname jungle, without the chain of command strongly recommended by Finny and Alan, the rift between the factions began to widen. Richards encouraged a casual attitude,



quickly taken up by those in his camp. This fostered a swaggering bravado, a contemptuous disregard for the opposition and, in time, an equal contempt for the Jungle Commandos, the very men they were there to train.

Finny, Alan and Bill drew themselves apart, determined to maintain a professional approach. They had lost confidence in their companions and decided that they would "stick together like glue and watch each others' backs."

The dugout was dragged into a small inlet until the water was too shallow to drag it any farther. Here the men shouldered their heavy backpacks and followed Edward as he led them through the jungle. Under the trees, the night was pitch black and alive with flying insects, most of which seemed to bite or sting. Mozzie repellent seemed to attract them. Dripping sweat stung the mens' eyes. Underbrush snagged and snared their feet, causing them to stumble. Thorns and mysterious spiked plant life, invisible in the dark, slashed any exposed portion of skin. The backpacks, which had seemed of reasonable weight in the air-conditioned comfort of a St. Laurent hotel room, now felt as if they were full of rocks. Everyone regretted having packed some treasured luxury or another.

Of more concern was the noise being made by Richards and his faction. Just trekking with them was enough to see they were like boy scouts. They thought this was just a game. Even whilst buying their shotguns, they were running around pretending to shoot at each other. Before leaving French Guiana, they had already started to disagree among themselves about routes, targets, tasks; they began to argue about anything and everything. Finny and Alan were growing increasingly worried about this.

The lack of normal unit discipline was

Brit merc on bank of the Marowijne (Maroni) River. As a past SOF correspondent noted, "Suriname is interesting. You've got guerrillas who're into voodoo led by British mercenaries fighting with shotguns, crossbows and dynamite against a...dictator in this incredible malarial jungle teeming with anacondas and piranhas." He only left out the dinner plate-sized spiders and 8-inch-long scorpions.

INSET: Jungle Commando "Mad Man" (left), so called because his name, Madan, sounded like it — and because he actually was. Mad Man had served in the French Foreign Legion, rejoined and deserted, and along the way escaped from a mental asylum in French Guiana.

causing problems. Words were exchanged. There were hissed requests that the Richards faction shut up and knuckle down. Richards' cohorts would respond by staging a pantomime of exaggerated vigilance for a few minutes, then collapse into fits of giggles. This did not bode well for the future.

A couple of hours later, the group harbored up for the night. It hadn't been a long trek, but it was late and everyone was ready for sleep. A rota was worked out for sentry stags. Supper was a quick, uncooked snack. Jungle noises were drowned out by loud debates among Richards' faction about what to do next. Richards seemed to thrive on the anarchy. After much argument it was decided that in the morning, Richards would lead his faction on a reconnaissance patrol of the army base at Albina. Edward assured them that the army never came out on night patrols, or for that matter, only rarely on daylight patrols!

Finny, Alan and Bill bivied in the same area, physically demonstrating their solidarity. The rest were scattered about randomly. Pat, despite his claimed SAS past, sat on his backpack examining his feet and

complaining about blisters. The two journalists, too tired to talk, were already asleep.

Everyone was up with the dawn. At 0500 hours, Richards, Liam and Sven set off on their recce. Pat remained behind with the Marine faction to nurse his blisters. That afternoon, after Richards' return, the Marine faction went to recce the same position. It was carried out more for curiosity than for any military plan. That the army in Albina was extremely slack in its security precautions was confirmed. When sentries with an LMG manning an observation bunker came off-duty, they walked off to call their relief, leaving the LMG un-

Merc leader John Richards, AKA John Andrews, inside Suriname. Different sources have stated that Richards approached Suriname government officials overseas, offering to kill Brunswijk for a price. He then took a mercenary contract to work *with* the Jungle Commandos. End result? Richards attacked Brunswijk but was gunned down first.

guarded in the bunker!

Having satisfied their curiosity, the group prepared to push on toward the Jungle Commando base at Moengo. Moengo had been captured by the Jungle Commandos a few months previously. It was a bloodless victory, won by stealth.

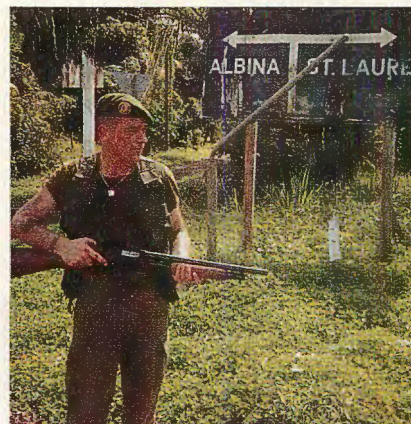

SOF IN SURINAME

Suriname first came onto SOF's screen after Desi Bouterse's military coup in 1980. Coups are always of great interest to SOF's Editor/Publisher Robert K. Brown, especially, as in this case, when democratic governments are ousted by gun-toting thugs. Our initial reaction was "Where the hell is Suriname?" followed by "Let's get a team down there!" Busy with events in Africa and Asia and then Central America, however, it was several years before we actually went. Uncle Bob's interest in Suriname was whetted once again late in 1986 when news of a rebellion against Bouterse's now-communist government filtered out of the jungle. Anticommunists, especially those with rifles, occupy a high priority in SOF's world, so a serious effort was made to get some of our "action-journalists" down there on the scene.

In March 1987, a three-man team, led by our intrepid publisher himself, deployed to South America. Our missions were to contact the guerrillas, document their situation, join them on some combat operations, then bring the news out to our anxiously waiting readership. Execution of the plan was not quite so clear. We traveled to Cayenne, French Guiana, where we sampled a variety of hotel accommodations while trying to reach our rebel liaison officer. One of the hotels came complete with hot and cold running rats, and another had hot topless ladies scattered around the swimming pool. No prize for guessing our preference.

Several days later, we received a message saying we should move to a small town closer to the action and contact a Mr. "X." So in a rickety taxi, off we set. Many hours and many francs later, our destination came into view. Used as the setting for part of Steve McQueen's movie version of "Papillon" (concerning the notorious prison of Devil's Island), St. Laurent du Maroni is a sun-beaten village on

the bank of an Amazon-like river called the Marowijne in Dutch, Maroni by the French. We were soon to see more Maroni than any of us wanted.

After we checked into our plush, six-dollar-a-day room — RKB noted that there was no extra charge for the cockroaches — we skulked around town looking for our contact. Amazingly, we found him. He said we had to go upriver to meet the commander of the guerrilla "army," known locally as the "Jungle Commando." Because of stringent security measures, he said, our departure had to be before dawn to avoid enemy agents and river patrol boats, so we turned in early to get up early. The hot, moist, pre-dawn air on the river bank muffled our sounds as we surreptitiously slipped into a waiting dugout at 0400.



Gary (left), Ronny Brunswijk's chief bodyguard, killed in March 1990 Paramaribo shoot-out when Brunswijk was taken prisoner by Bouterse.

Congratulating ourselves on our successful clandestine approach, we looked around for Mr. "X." He wasn't there. He still wasn't there at 0530 when the sun came up. At 1000, long after we had disembarked and found some shade to sit in, he came sauntering down to the dock, obviously having partied all night long. Tough work being a guerrilla spy in St. Laurent! After pushing our way through the throng of various and

assorted beggars, ragamuffins, government spies and other onlookers who had gathered around us in the hours since dawn, we silently resumed our seats in the dugout and set off to find the answers to life in the jungle.

Except for a few incidents, the 10-hour trip upriver was uneventful, even boring. After all, who can get excited when an enemy gunboat appears, or when nearly capsizing in piranha-infested rapids, or when a snake drops out of an overhanging branch and makes for the nearest dugout? Certainly not SOF staffers. As long as our cameras stayed dry, we were happy. And a scorching sun must have helped the cameras, if not our film. In due course, we made it to the hall of the jungle king, a chap named Ronny Brunswijk.

Ronny had been one of Bouterse's bodyguards until 1986, when for reasons perhaps unknown even to himself, he decided to leave the army and form one of his own. Perhaps his instant promotion from private to commander-in-chief had something to do with it, or perhaps he was facing a court martial. A Brit merc working with him at the time described him as "a 25 year old with the brain of a six year old." Whatever the circumstances, he was boss, and had even convinced some twit of a journalist to nickname him "the Robin Hood of Suriname."

Limited space precludes a full description of our investigation (otherwise detailed in SOF's June and August '87 issues), but when we gratefully departed rebel HQ many days later, we decided that, despite multiple, glaring deficiencies, Brunswijk's Jungle Commando had sufficient merit as an opposition to Suriname's murderous military dictatorship to warrant support. A follow-up visit was made to Holland to confirm

Continued on next page



Jungle Commando Stanley and Brit merc Finny armed with FN FALs, standard personal weapon for the insurgent force.

One Saturday, the entire army garrison attended a local football match. The Jungle Commandos simply surrounded the stadium and captured the unarmed soldiers as they left after the match.

As the mercenaries prepared to move out, the two journalists unexpectedly announced that they were going to turn back. Reaction was divided. Richards and his

faction were disappointed, having imagined they were to be the subject of some glowing press report. Finny, Alan and Bill were quietly pleased, feeling that it had been a mistake to allow them to come along in the first place. Pat, loudly suffering from his blisters, announced that he too was throwing in the towel. By this stage, it had been established that he had never served in the SAS after all, but was only anxious to secure peer acceptance.

With these three gone, the six remaining men set off for Moengo, 30 miles away. To

SOF IN SURINAME

the legitimacy of the rebel political leadership, and another SOF team was sent back to the jungle some months later to check on a few specific requirements.

Meanwhile, RKB tried to find someone interested in providing them medical or other humanitarian aid. The meeting in Holland with a former prime minister of Suriname, Henk Chin-a-sen, was a good one, and the report from our team in the jungle was also very favorable. Unfortunately, though, no one else in the world was in the least interested, and we had to turn our attention back to other matters.

For two more years, the situation developed without much notice from us or anyone else. Due to continued rebel pressure and deteriorating economic conditions, Bouterse had to allow elections — of a sort — but he held onto his position as commander of the armed forces, and de facto control of the country, while tolerating some activity by elected officials. He ignores them when it suits him to.

In late 1989 SOF sent then-Assistant Managing Editor John Coleman down for a look, his primary mission to verify an interesting rumor that had come our way. According to what we considered a valid source, Ronny had received at least one, if not more, substantial shipments of new weapons ranging from M16s and M60 machine guns to LAWs and mortars. If true, we figured it would substantially alter the balance of power and perhaps even shoot Ronny into power.

Coleman spent an interesting week dealing with a variety of spooks, gunrunners, guerrillas (and all their would-be counterparts), French military, and the normal flotsam and jetsam who inhabit places like St. Laurent. Along with being asked (quite politely) to depart the country by certain official security types, he came away with the answer that the supposed vast shipment of arms was a figment of someone's overactive imagination. As has be-

come the standard on our trips, however, he was hit up for cash — and lots of it.

"This time around they wanted a quarter-mil — down from the half-mil of a couple years ago — and said that would be enough to equip Ronny's forces with enough firepower to put them in the capital within two weeks," Coleman said. "My initial thought was that a quarter-million dollars would go a long way toward making someone's retirement a comfortable one.

"I dodged the issue of money and asked what sort of weapons they

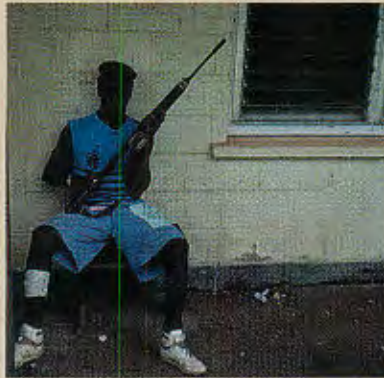

Jungle Commando Dougie, killed in Paramaribo shoot-out as one of Ronny Brunswijk's bodyguards.

actually wanted. When they realized that I wasn't going to pull out a checkbook then and there, they came back with a shopping list that was quite reasonable for the force they were fielding: RPGs, 2-inch mortars, more GPMGs and LMGs, that sort of thing.

"I was told that they preferred to have the weapons rather than the cash, but, since it would be easier for *them* to obtain the weapons legally, they'd just as soon have the money after all.

"SOF may be generous with its money when it comes to good causes, but we're not *that* generous..."

After the elections, guerrilla activity, never very intense, declined fur-

ther while Brunswijk and his men waited to see what changes would be made. Talks were held, treaties were signed, but not much changed on either side. Brunswijk was then invited to a meeting with Bouterse, under a temporary truce, on 26 March 1990. He went to the meeting accompanied by two bodyguards, but should have taken 20. Leaving his protection at the foot of a stairway leading to Bouterse's office, he was in the midst of discussions with Bouterse when several volleys of automatic fire from downstairs disrupted the proceedings. Minutes later, several blood-splattered soldiers entered the meeting room and told Bouterse that his orders had been carried out and that the bodyguards were dead. Brunswijk was then arrested.

Undoubtedly that would have been the end of our guerrilla leader had some unknown individual not quickly devised a plan to spring him. On 27 March, the Jungle Commandos seized a major hydroelectric plant and turned off the power to a large part of Suriname. The power would stay off, Bouterse was informed, until their chief was set free. Hard hit were bauxite mines, at least one major city, and an aluminum plant with molten metal suddenly — and potentially disastrously, from an economic point of view — hardening in electric crucibles. It was a slight miscalculation on Bouterse's part. His glee at capturing a longtime adversary must have turned quite bitter when he was forced to release Brunswijk on 28 March.

As we go to press, Suriname is still in turmoil, but with peace possible at any time. The biggest impediment to peace remains Desi Bouterse's refusal to acknowledge any authority but his own. We think he should take a long vacation. Devil's Island is not far away, and Desi would fit right in amongst the local ghosts.

— Robert MacKenzie

avoid the oppressive heat of the day, they opted to march at night. Whilst it proved to be a hard, grueling slog, they managed the full distance in one long night. The leader of the Jungle Commandos, Ronny Brunswijk, welcomed them, and life soon settled into a routine.

Whilst the Jungle Commando base itself was a mile out of Moengo, the mercenaries were billeted in town, in the old YWCA building. Moengo also boasted a bar, the "Tasty Bite." After sampling its dubious culinary delights, the Brits duly christened the place the "Nasty Bite."

Even with Moengo totally under the control of the Jungle Commando, the local police carried out normal duties. That they were able to operate within Jungle Commando-controlled territory is an interesting insight into the quirky nature of the war in Suriname. The police endeavor to maintain a position of neutrality. As unlikely as it may sound, the system seems to work.

Without the structure of a military unit, it was difficult to set up a proper training program. Finny, Alan and Bill attempted to initiate regular training sessions. This included lectures, as well as practice on all basic military skills. Range shooting was limited as ammunition was not abundantly available. Whilst the three did what they could to motivate the Jungle Commandos to take advantage of the expertise they had to offer, the dwindling cooperation between the two mercenary factions hampered progress.

Richards' faction eased into a routine centered around the shade of the bar in the Nasty Bite, downing cold bottles of Parbo beer, with abstract talk of future operations. This was interrupted only by occasional attempts at rudimentary training sessions, usually when Ronny Brunswijk was in Moengo. As time went on, however, Richards and his compatriots seemed to develop an increasing contempt for the Jungle Commandos. Their training efforts dwindled.

Richards' faction gained an addition with Brit mercs fuse home-made grenades inside Suriname. Efforts such as this helped allay some of Ronny Brunswijk's suspicions about part of his foreign merc force.



the arrival of Joseph, yet another ex-Foreign Legion Brit from 2nd REP. Joseph was already well known to Liam and Sven, and fitted in comfortably with that group.

Initially, the Jungle Commandos responded enthusiastically to the training being conducted by the Marine faction of the mercenaries, despite the demanding nature of physical fitness sessions under the hot sun. By the end of 10 days, however, they had tired of the vigorous activity being imposed by their (still keen) instructors. Attendance tailed off. Ronny Brunswijk was unwilling to enforce any real discipline to make his men attend. Instead, he adopted a more philosophical attitude: the men could attend if they wanted to, and not attend if they didn't want to. Without Ronny Brunswijk's full support for the training program, however, the "didn't want to's" began to outnumber the "want to's."

As the popularity of the training sessions dwindled, the Marine faction kept busy by overhauling the Jungle Commandos' weapons. There was a large variety to choose from, including Beretta PM 12 9mm SMGs, UZIs, shotguns of various and dubious types, AK-47s, FN MAG 58 GPMGs, and the staple weapon of the Jungle Commandos, the 7.62mm FN FAL. The weapons all had one thing in common: they were in desperate need of cleaning. That each FN FAL had a cleaning kit in the pistol grip was a revelation to the Jungle Commandos; how to use them, an even greater mystery.

At this time there was a ceasefire between Ronny Brunswijk and the army. For this reason when, after three weeks, Richards decided to set off on a fighting patrol, it was targeted not at the army, but the Tacujana Indians, with whom the Bush Negro Jungle Commandos are also at war.

The Tacujana Indians are the indigenous people of Suriname, the Bush Negroes being descendants of escaped slaves of European settlers. The Suriname government of Desi Bouterse exploits ethnic hatred between the Tacujana and the Bush Negroes by arming the Tacujana with modern weapons and encouraging them — though they need little encouragement — to fight the Jungle Commandos. Richards intended to locate and kill a local Tacujana Indian leader, Commander Thomas.

Before setting off, Richards requested that Finny and Alan hand over the FN FALs which they had cleaned and zeroed for their personal use, together with their supply of grenades. As there were plenty of other weapons to choose from, they refused to



tacked Kraka.

In due course, a message arrived for Finny, Alan and Bill to see Ronny Brunswijk. When they arrived at the appointed meeting, Ronny was surrounded by an unusually large escort that was strangely quiet — almost sullen. They were all heavily armed. Something was up. Something unpleasant.

It was confirmed that Richards, in direct violation of Ronny Brunswijk's orders, had attacked the army base at Kraka (killing seven soldiers and wounding 14). He had endangered the ceasefire. While this alone was cause for concern, it soon became evident that it was only the tip of the iceberg. Events had obviously taken a very nasty turn. The remaining group of mercenaries were ignorant of what was at the root of all this, but the atmosphere was defi-

LEFT: Mercs during their first day inside Suriname. Problems had already arisen between the ex-Foreign Legion and ex-Brit Army factions; later, all were close to death because of John Richards' treachery.

hand them over. Richards was extremely angry and a public argument raged briefly about ownership of the weapons. At the end of the day, possession proved to be nine-tenths of the law. As the Marines seemed willing to use the weapons in order to keep them, Richards backed down. Neither faction realized at the time that this argument would later indirectly save the lives of the Marine faction, as well as seal Richards' fate.

The split between the two factions was now complete. Bad feelings festered like an open jungle sore. Several of the Jungle Commandos, with whom Finny, Alan and Bill got along, said they had heard Richards and Sven plotting to kill them! The lingua franca for the Bush Negroes is "Taki-Taki" (literally "Talk-Talk"), but many speak Dutch (Suriname being an ex-Dutch colony) and English, for which the Marine faction was now very thankful.

Nothing came of this rumored death threat, but it could not be taken lightly, and the Marine faction kept a close watch on Richards. Eventually, he and his men set out with some of the Jungle Commandos.

That Richards and the others had set out on a fighting patrol with nothing more than a couple of first-field dressings for a medical kit came as no surprise. Finny and Alan both said their packs were well-stocked with vital medical kits, and were pleased to discover that the only ex-Legion member to side with them, Bill, was an extremely competent paramedic.

After Richards' departure, the camp became more relaxed. Not only had there been friction between the divided mercenary factions, but also between Richards' group and some of the Jungle Commandos. The Jungle Commandos felt slighted by the off-hand manner of Richards and his followers, who had been playing the "Big White Boss" role to the hilt. Everyone was pleased to see their backs moving into the



Typical Suriname guerrilla/mercenary kit: Mossberg shotgun, UZI, sawn-off shotgun, and homemade grenades.

distance.

As Ronny Brunswijk assigned no tasks to the remaining mercenaries, they had to find ways to keep themselves busy. Having cleaned every weapon they could find, they began assembling homemade hand-grenades and claymore mines, utilizing a supply of explosives, detonators, scraps of metal and ball bearings salvaged from an abandoned bauxite mine. The resulting handicraft looked more dangerous to the user than the target! Later events were to prove otherwise.

After Richards had been away for a few days, a rumor spread that an army base at Kraka had been attacked and overrun by his faction. As there was a ceasefire in effect, this made little sense. No one could think of a reason why Richards should have at-

nity threatening. It was to be a long, tense afternoon.

Ronny questioned them in great detail about Richards and how he had recruited them. He also asked if they had ever heard of "John Andrews." Those from the remaining group told Ronny this was an alias that Richards often used. Their frank admission that they knew of this alias seemed to subtly alter the atmosphere in their favor.

After several more hours of questioning, the facts slowly began to emerge. Ronny claimed to have received information from Dutch intelligence that Richards had actively tried to secure a contract to kill him. According to Ronny's source, Richards had visited the Suriname Embassy both in Holland and French Guiana in connection with this contract. The three Brits realized that their fate hung by a very thin thread. They were obviously on trial here to establish their part in a plot to kill Ronny



Brunswijk.

The bad blood between the two mercenary factions had been noted by Ronny, however, and this was now in their favor. The effort they had put into military training and overhauling the weapons, together with the small arsenal of home-made mines and grenades they had constructed, also reflected well on them. Adding to their defense was the public argument between themselves and Richards, shortly before his departure on the fighting patrol.

Eventually, Ronny Brunswijk expressed his belief that they were not involved in the assassination plot. After the mercenaries assured Ronny of their continued loyal support, they were allowed to leave. It was a sobering experience to realize that, while recruiting them with one hand, Richards had been selling them down the river with the other.

ABOVE: Ronny Brunswijk's latest crop of merc advisers inside Suriname. Merc leader John Richards (bottom, center) failed to establish a chain of command or enforce much military discipline, which helped create a rift in the merc camp.

BELOW: Mercs set up in ambush position. It was well executed — and quite deadly.



In order to get close enough to kill Brunswijk, Richards had accepted a contract, financed by Dutch sympathizers in Holland, to supply mercenaries to the Jungle Commando. It afforded him a perfect cover, but one that placed no value on the lives of the men he had brought with him. As Ronny Brunswijk is idolized by the men of the Jungle Commando, it was hard to fathom how Richards had hoped to escape after the assassination.

Richards could not know that his plot had been discovered. Meanwhile, Finny, Alan and Bill kept up the training and mingled as much as possible with the Jungle Commandos, defusing the suspicion which had fallen on them and trying to maintain the



ABOVE: Finny lays explosives in preparation for ambush on Tacujana Indians — yet another faction fighting for indeterminate reasons in Suriname.

easy rapport which had served them so well before.

Finally, Richards, Liam, Sven and Joseph flew back in from Langatabbitje on a small Cessna belonging to the Jungle Commandos. Ronny Brunswijk was waiting for them with a reception committee. He greeted Richards, trying not to betray his hand whilst questioning him about the Kraka attack. Richards was defensive, and dismissed the possibility of the attack affecting the ceasefire. Angry words were exchanged, and Richards must have sensed something more behind the charged atmosphere. Without warning, he and his men suddenly turned on their heels and bolted for the cover of the nearby jungle. The Jungle Commandos were taken unawares and in a few short strides, Richards and his men had vanished into the deep shadows. It was too late for Ronny to issue orders; the treacherous mercenaries were gone.

Unwilling to risk the lives of his own

Continued on page 114

Rendering of successful ambush by Brit mercs against Tacujana Indian attack force. Two of the mercs commanded the kill group while the third controlled the cutoff group.

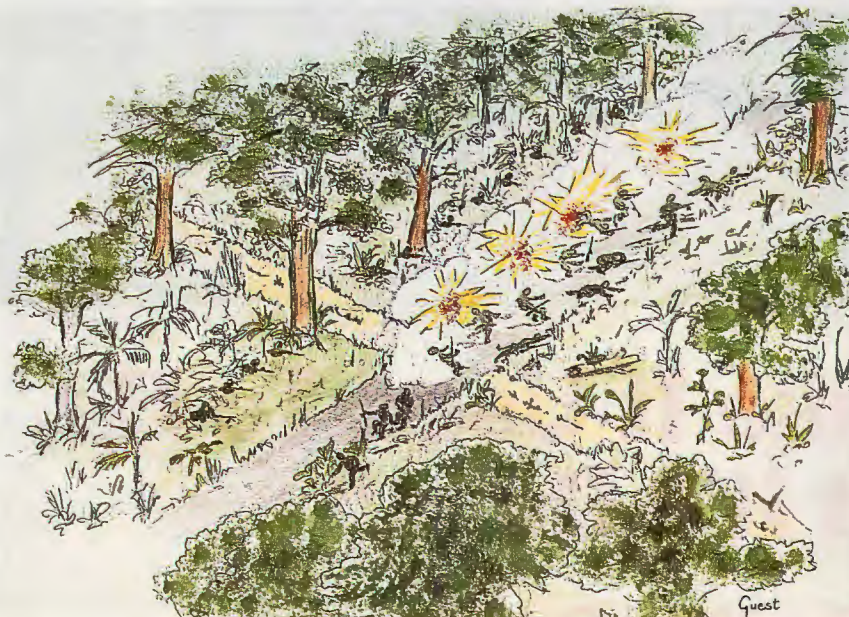



**“It Ain’t Like It Used To Be,
But It’ll Do ...”**

The Wild Bunch

SOF TRAINS CONTRAS

Under Rockets Red Glare

by Harry Claflin

"On March 14 [1985], Mr. Singlaub reported to [Lt. Col.] North on his recent trip. He said that he had met with several FDN leaders and that he had agreed to recruit and send 'a few American trainers' to provide 'specific skills not available within this (sic) current resources.' Mr. Singlaub specified that 'these will be civilian (former military or CIA personnel) who will do training only and not participate in combat operations.'"

—Tower Commission Report
President's Special Review Board, p. C-4.

With these words, yet another intriguing chapter in the famous Iran-Contra Affair was written — intriguing, but ambiguous. Perhaps appropriate in a dry government report, there is nothing more about these "few American trainers" and their experiences in the battle zone. Nothing about dark nights filled with automatic weapons fire, exploding "Katushka" rockets or invading Sandinistas on the horizon. For this, one need look no further than the pages of SOF.

— R.K.B.

MAJOR General John K. Singlaub, a staunch supporter of the war against the communist Sandinistas in Nicaragua, wanted a team of experts to train a Nicaraguan Democratic Front (FDN) Special Operations Commando (COE) unit for deep penetration into Nicaragua. The COE was an elite unit of the Nicaraguan resistance, the contras. Singlaub contacted Robert K. Brown of *Soldier of Fortune* Magazine and requested he recruit appropriate personnel through his "old boy network" for the mission.

The team would consist of a team commander, a combination medic/intel specialist, a demo man, a weapons and commo man, and a special operations man, all of whom would have extensive combat experience in unconventional warfare in various hot spots around the world. My first meeting with four of the team members eventually recruited by RKB took place at Singlaub's mountain hideaway in Colorado. The General called us into his SOF's "A-Team" recruited by Robert K. Brown to provide private sector training to the contras. RKB mounted; author is standing left rear. Photo: Topaz

briefing room where we sat down around a table. None of us had really spoken to each other before, so introductions were in order.

The team RKB rounded up included Colonel "Devin Benson," who was to serve as team leader. Benson had recently retired from the U.S. Army, with credentials ranging from Special Forces in Vietnam to CO, Ranger School. He had also been assigned to the MilGp (U.S. Military Group) in El Salvador. "Phil Topaz," the medic, had served in Vietnam. I.W. Harper, the demo man, had 20 years CIA experience under his belt. I was to be the weapons and commo man with a background in Force Recon in Vietnam, with more recent experience in El Salvador as a military adviser. Jack Thompson, to be in charge of marksmanship and special operations, had been with the Marines in Vietnam and the SAS in Rhodesia. RKB would serve as liaison.

After some small talk, we got down to discussing the reason we were there. Singlaub's mission statement was clear and concise, to the effect of: "Gentlemen, you will leave here and travel to Tegucigalpa with your equipment and link up with members of the FDN. You will then be taken to Camp Las Vegas on the Nicaraguan border. There, you will set up and conduct training for select units for deep penetration operations into Nicaragua.

"The length of training for the mission will be 90 days, starting from the time you get to Camp Las Vegas. Training sites have already been established, and the select units will be there waiting for you. Each of you are experts in your field, so you need

not be told what to do. Thank you, and good luck."

The trip from Colorado to Tegucigalpa was uneventful. Luckily, our contacts were waiting for us when we arrived. Even with our hundreds of pounds of military gear, clearing customs was no problem. After loading us and our gear into waiting vehicles, our contacts took us to a safe house in town, where we met up with the local FDN officials. They were friendly enough, but a little confused regarding why we were there. Benson and RKB explained to them that we were the team sent down by Singlaub to set up their training program. Our hosts' faces went totally blank — they were going to have to make some

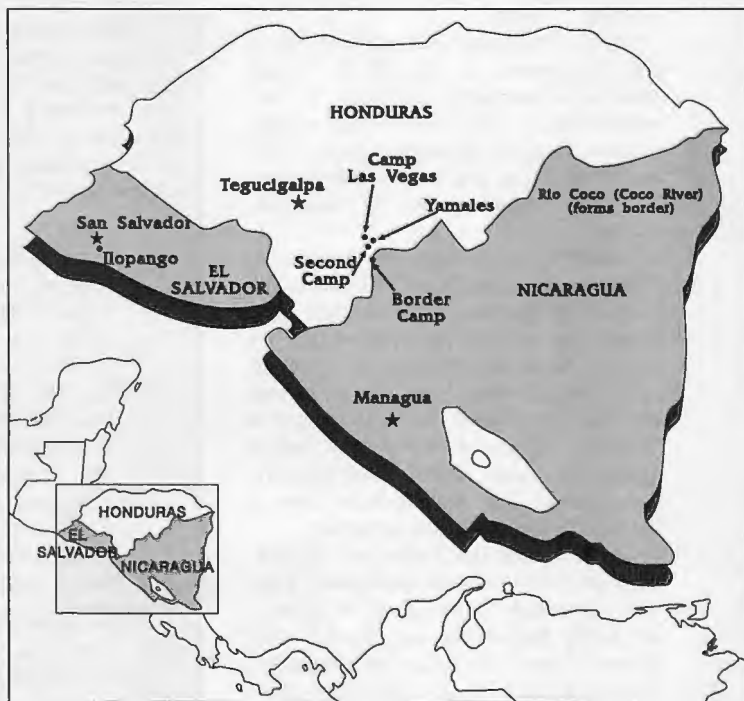

phone calls.

So we sat around for a couple of hours twiddling our thumbs while our friends made their calls. Finally they came back to say there would be transportation for us to Camp Las Vegas leaving tomorrow. Fine, we thought, but what about tonight? No problem — we would check into a local hotel. This seemingly easy task was accomplished only after another two hours wait for transportation to the hotel. So far, so

QUESTIONS FOR THE CIA

Having spent several weeks at the contra command and training complex, we certainly had questions regarding what the hell the CIA had been doing there and why.

When the U.S. Congress pulled the rug from under the contras and terminated aid in October 1984, the CIA, with the exception of a few liaison personnel, simply packed up and went home. The CIA, who up until that time had been responsible for all logistics, left the contras without any idea how to procure weapons, ammo, boots, uniforms, field gear or any of the necessary items to run a guerrilla war. I mean, if you're in the middle of a jungle fighting a vicious war, your troops need a new pair of boots every three months, so where the hell do you get them? There are no Army-Navy stores in Yamales. They didn't even instruct them on how to operate the sophisticated commo vans they had provided.

Then there was the problem of resupplying units in the field. It took a

minimum of three to four weeks to walk to some operational areas. While supported by the CIA, the contras were almost entirely resupplied by air. Suddenly, the "air" was gone. I remember one of our SOF teams with the contras in February '85 saying Colonel Enrique Bermudez, military leader of the FDN, bemoaned the fact he had no way to resupply his units inside. Couldn't the Agency have told them to get mules? (They did get mules by the time we got there in April.) Bermudez was also complaining about how he could no longer run battalion-size ops. Why didn't the Agency point out that he could conduct company- or even platoon-sized ops and still cause the Sandinistas a lot of heartburn?

A former high-ranking State Department official told me that early on, the basic error in strategy the Agency made was in emulating the CIA operation in Laos — using only aerial resupply.

The CIA also made no effort to

develop a resistance infrastructure.

When, on the odd occasion, the contras tried to develop an underground organization on their own, it was quickly wrapped up by the Sandinista secret police. Toward the end of our tour with the contras, I remember six civilians were brought into our camp from Managua to receive a crash course in demo and sabotage. Every rule of tradecraft was broken. It took them three weeks to walk to our camp, one week for training, and three weeks to walk back to Managua — with no cover stories! They had no war names; they were not placed in isolation. It was not just suspected, but known, that Sandinista intelligence had numerous operatives throughout the contra organization. Needless to say their whole net was wrapped up within 30 days of their return home. Not exactly a glorious chapter in the Agency's history.

— Robert K. Brown

good! At least we had gotten there and made contact. Now all we had to do was get a good night's sleep and wait for the morning ... Right?

Wrong. Five days came and went before our ride showed up. Ah, life in Central America! Fortunately, everyone in our team had been in this business long enough to know the hurry-up-and-wait game. Still, being told "your ride will be here tomorrow" was beginning to get real old, real fast.

According to our map, the distance to Camp Las Vegas was about 110 miles. We guessed the time to get there would total about three to four hours, providing no serious problems cropped up. Wrong again! Thirteen hours later, we rolled into the camp. The "road" was something of a nightmare, beginning on pavement, which turned into gravel, which turned into dirt, which turned into nothing more than a bulldozed path through the mountains.

As we neared the border, we encountered our first Honduran checkpoint. They were not friendly. After a good 30 minutes, we finally bluffed our way through after Benson showed the officer in charge his retired military I.D. card. From this point, our "road" got even scarier, turning into 100 percent pure shit. From this area, however, we started to see the first contras on the road.

The road marks the border between Honduras and Nicaragua, and we could see Sandinista bunkers on the hillsides maybe 300 meters away. Not a good feeling. Our driver was saying that the Sandinistas fired at him on some days, and on others let him go. Members of our team started joking about what side of the jeep they were sitting

SOF AND THE SUPPORT OF FREEDOM IN CENTRAL AMERICA

Since mid-1985, nearly all of SOF's ES/NDF (El Salvador/Nicaragua Defense Fund) donations have gone to the Nicaraguan resistance, the contras. Over the same period of time, RRI (Refugee Relief International) has sent millions of dollars' worth of medical supplies, first to El Salvador, then to Nicaraguan refugees in Honduras.

The following lists the quantities of some of the major items contributed by SOF readers from 1985 to 1989:

| ITEM | QUANTITY |
|--|----------|
| Jackets, fatigue (total), ea. | 1,469 |
| Trousers, fatigue (total), prs. | 1,088 |
| Caps & hats, ea. | 670 |
| Boots, prs. | 363 |
| Socks, prs. | 2,210 |
| Jackets, field, ea. | 126 |
| Ponchos, ea. | 68 |
| Pistol belts, ea. | 763 |
| LBE suspenders, sets: | 722 |
| Canteens, ea. | 470 |
| Butt packs, ea. | 263 |
| ALICE packs, rucksacks, etc. ea. | 50 |
| Map cases, transparent plastic, 13"x 18" ea. | 760 |

There were many other items donated, such as T-shirts, web equipment and magazine pouches. The above list also excludes the tons of medical supplies shipped by RRI. Replacement value for comparable items at retail prices would be more than \$100,000. Cumulative weight of these shipments was 13,565 lbs. — that's over six tons. Thanks, SOF'ers.

— Alex McColl
Director of Special Projects

on, knowing at the same time it would make no difference if the Sandinistas decided to open fire.

Having passed maybe a dozen FDN checkpoints by this time, our driver leaned over to say we were just about there — only

one more hour. Oh boy! How does that translate into real time? At the next checkpoint, we waited for 30 minutes while guys stood around trying to figure out what to do with us. Finally, the driver was told to take us to the nearest camp for the night.

By this time it was close to midnight, raining like a pig, totally dark, and we were driving down a dozer path filled with 20-foot-high buck brush with mud up to the doors and no idea in hell where we were going. After another 20 minutes, we pulled into a clearing filled with contras. The FDN military leader, Colonel Enrique Bermudez, welcomed us and we were soon billeted in a supply hut. He said he would see us in the morning. After the vicious 13-hour jeep ride, however, no matter what I tried, I could not get to sleep. But I wasn't alone — everyone in our team started telling stories about other shitty places they had been. At around 0300, we dozed off. Oh good! The roosters were starting up!

I looked at my watch. It was 0530 and the roosters were out in force. There must have been 50 of the bastards. By the time we left our beloved Camp Las Vegas, RKB had thought of more ways to get rid of the rooster population than most people could possibly dream of. In the end, he said he would just spit Skoal at them, knocking them dead (or senseless), this up to an impressive 10-foot distance. Meanwhile, we felt like hell. It was almost comical how stiff we were.

As light came, so did some curious onlookers. We had changed into jungle fatigues and were looking forward to getting the show on the road. At 0700, the comandante came by to ask if we wanted anything to eat. Sure, why not? What we ate was to be the same thing we would eat for every last meal for the rest of the tour: beans and rice with black coffee. Yum!

It didn't take long for us to break out the Tabasco sauce and learn to watch out for little rocks in the beans. The coffee was potent — if this stuff didn't wake you up in the morning, you were dead. This place looked like a hobo camp with somewhere around 500 inhabitants. Safe to say there was no police call. Around 1000 hours our jeep pulled up and the driver said we were going to another camp. It turned out to be a copy of Camp Las Vegas — four wooden shacks and a couple hundred blue plastic shelters stuck in the brush.

As on our first day, the reaction was friendly but confused at the new camp. Again as on the first day, we had to explain

More than 500,000 rounds of 7.62x39mm ammo and 288 PG-7 rounds, all manufactured in the People's Republic of China, arrived in our camp in late April '85. They were purchased with private funds. Photo: Robert K. Brown



that we were the training team sent by Singlaub to train the COE. Blank stares. No one had been informed about any of this. As it turned out, the COE was across the border in Nicaragua and would not be back for another two or three weeks anyway. If we wanted to work with one of the other units, though, that would be fine. It took a minute for all of this to soak in. Shocked, we just looked at each other. Communications from the FDN in the States and Honduras left something to be desired.

On this less-than-happy note, Comandante Bermudez said we would be working with him and left. After settling into a tent and downing our mandatory beans and rice, we sat down and tried to figure out what the hell had gone wrong. We never did. And with the rain plowing down again, happy campers we were not.

On the way down here, we had stopped in New Orleans to talk to Mario Calero, FDN chief of logistics, who was in contact with Singlaub, and appeared to be very excited about our team coming down. He said everything would be ready for us here, and that Bermudez would have everything we needed for our training. Obviously, this was not the case.



Lesson learned: Always check around your quarters to see what surprises may await. We found 37 cases of grenades, 52 cases of 60mm mortar rounds, 56 cases of 57mm recoilless rounds 25 feet behind our tent concealed in the bush. We prompted the contras to move it — immediately! Photo: Robert K. Brown

So we got together with Bermudez and his Tigers, the name of the unit we would be training, and asked about what was required. He said his men needed training in everything — ambushes, small unit tactics, weapons maintenance, hand-to-hand combat, demolitions — you name it. We found he had no ammo, no medical supplies, no explosives — nothing but guns and bodies. After a very long pause, Benson thanked him and said we would start tomorrow. What a deal. It was obvious our ability to improvise would be sorely tested.

Topaz said he would set up a medic station with the supplies we had brought, and devise a general first aid course. I would start a weapons maintenance check for all weapons. As night fell, I brought up



Newsweek used SOF photos; was unaware of SOF's contra mission.

the point that none of us had weapons. Others said this little point had been on their minds as well. After some discussion, we decided to let it go until morning. I don't think we slept real well that night, either.

When the roosters hit full tilt, we knew it was time to get started. Within an hour, Topaz had a line of troops waiting at his medic station, and I was up to my neck in rusted-out MGs. These consisted mainly of M60s and RPDs, the M60s having frozen gas pistons. The overall condition of the guns was shit. It was plain the Tigers had not a clue about how to disassemble their weapons, let alone how to maintain them. We took care of that.

That evening RKB and Benson showed up, and we had the first of many debriefings. Topaz had seen around 100 troops that day, reporting most were malnourished with the usual tropical ailments. RKB and Benson had not been able to see Bermudez that afternoon, but had inspected a lot of the camp, which encompassed about five square miles.

The comandante came by that night and said he was very happy with our progress. We brought up the question of weapons for our team, and he said he would take care of it. No problema, senior! Another night with no protection.

RKB said he was going to take a piss and stepped out of the tent, only to come right back with our personal bodyguard, the youngest guard I've ever seen. The kid was not much taller than his AK-47, probably around 10 or 11 years old, and all business. When the roosters cranked up that morning, I got up to answer the call of nature, and there he was, still on duty and standing tall.

The next day, Bermudez had his Tiger company standing in formation at 0800 for



Contras cheered cook shack burning; broke up monotony. Phtot: Topaz

of all types, and M14s. Platoon leaders were taught how to clean the weapons so that they could teach their troops afterwards.

Dinner that night came with a surprise. Like something from a bad wild west movie, some hombre named "Pecos Bill," sitting atop a mule and wearing a mixture of cowboy and combat gear, sunglasses and a big grin, came riding up. He said that

inspection. They looked pretty good, all things considered. The weapons were in the same condition the MGs had been—probably uncleaned since they were made. Quite a mix, too: FN FALs, Spanish CETMEs, AKs

Bermudez had sent him to look after us. Then he got down from his mule and moved in with us.

With Pecos Bill around there was never a dull moment. After putting up his hammock, he commenced to tell us his whole life story. About 30 years old, his family owned one of the largest ranches in Nicaragua. He had been a lieutenant in Somoza's National Guard, but fled to El Salvador after the revolution. He was then an officer in the El Salvadoran army before he went to the United States and became an officer in the Marine Corps. He resigned his commission to return to Nicaragua to fight with the contras, and was now on Bermudez' staff in charge of S-2 (intelligence). While we trusted him to keep an eye on us, most of his stories had more holes than a soup strainer. There was little doubt that one of Pecos Bill's duties here was to keep Bermudez informed on just what we were up to. No problem.

After a thorough cleaning of some

Swedish Ks Bermudez had finally given us, it looked as though they'd do the trick. All had pitted bores, but in a squirt gun, it doesn't make much difference—at least we finally had something.

The rest of the week was pretty smooth. We had all settled into our routines, putting in close to 12 hours a day, when Bermudez decided to drop in. There with some of his staff, he said he

wanted to drive us off to see one of the camps closer to the border. Someone from his staff saw our obsolescent Swedish Ks and suggested we be issued UZIs. Good idea, amigo! Sure enough, in 15 minutes we

Rocket casing from one of 430 rockets fired into contra camp. Photo: Robert K. Brown





Our "security" was little bigger than his AK.
Photo: Topaz

had four brand new Belgian UZIs, complete with ammo pouches. At the new camp, Col. Bermudez wanted to know if we would like some cold beers. This was a surprise, as the Hondurans had supposedly banned

alcohol in this area. But with our answer in the affirmative, he took us to Yamales, a small town about a mile from the Nicaraguan border. We pulled up to a general store, a place right out of "The Wild Bunch." Horses were tied to hitching rails, and armed cowboys looked ready to rob a bank.

After five or six cold cervezas were downed no one was feeling any pain,

TOP: SOF'ers train contra Tiger Task Force troops in small unit tactics. Photo: Robert K. Brown

INSET: Clafin demonstrates how to take out a sentry on Benson. Photo: Robert K. Brown

including Bermudez, who felt like telling a story. "You know," he said, "the Sandinistas have spent a lot of time and money trying to find out what my battle plan is. They try to buy off my staff, infiltrate spies into my command, and still they cannot figure out my battle plan. You know why? Because I don't have one."

We all looked at each other. The man wasn't joking. But since he was the "jefe," we decided not to push the matter. Anyhow, our job was to train the troops — nothing else. It started getting dark; time to head back to camp. When we returned, there was quite a party going on. A band was playing, with the boys dancing up a storm. The place was wild. As with troops in any time or place, ways will be

found to circumvent the rules when breads and booze are prohibited.

Pecos Bill came wandering in about midnight, nearly drunk on his ass. We told him we were sitting this one out, at which point he said, "Well, shit," stepped outside, and let rip a whole magazine from his M16. We all grabbed our weapons, ready to drill ol' Pecos if he didn't start shaping up. Luckily for him, he wandered off and didn't come back that night.

"Pecos Bill" served as our liaison with Colonel Bermudez. Photo: Topaz

For the next two hours, we listened to automatic weapons being fired around the camp (a helluva waste



Continued on page 106

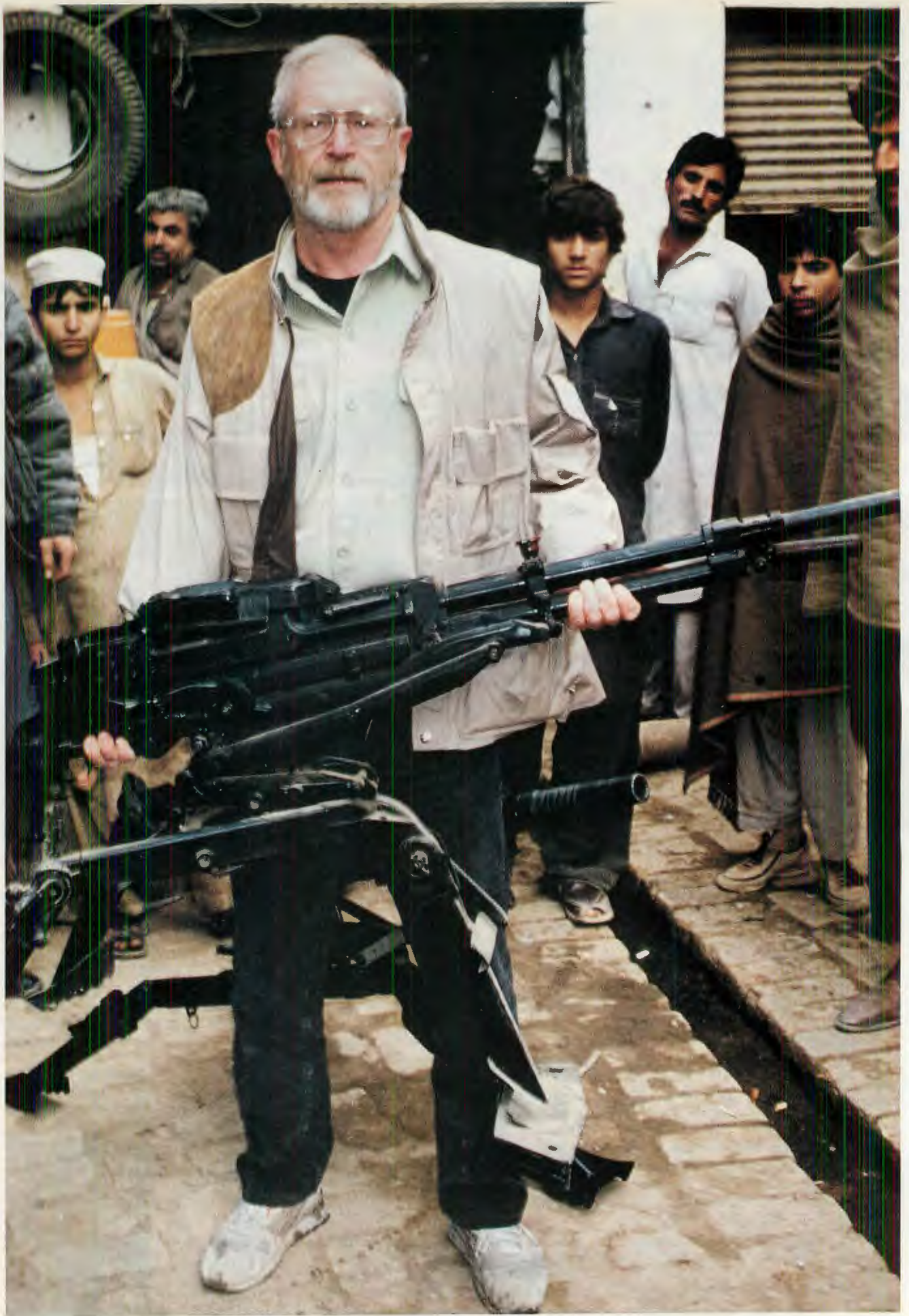

SOF TECH SCOOPS

Exclusive Weapons Coups from Around the Globe

by Peter G. Kokalis

NO other publication can match SOF's unparalleled record of intelligence coups in the field of military small arms. We have outfoxed the KGB, scooped the CIA and beaten every defense journal to the punch on so many occasions that without acknowledgement they have all come to rely upon SOF as a major source of technical intelligence. If the CIA and KGB have nothing else in common, it is the fact that tech intel personnel from each agency read SOF each and every month. And if this sounds like we're blowing our own horn, then so be it.

My first caper on the dark side of these intrigues involved our search for the elusive Soviet AGS-17 automatic grenade launcher in September 1982. SOF had been tracking the *Plamya* (flame), as it is called by Soviet troops, for almost 18 months previously. Our team in Pakistan in 1980 had found the AKS-74 rifle and its 5.45x39mm cartridges, but not the AGS-17. As the months and trips to Afghanistan continued, the AGS-17 continued to elude us. In early 1981 we obtained the first 30mm round for the AGS-17. In February of 1982, SOF staffer Jim Coyne obtained a picture of the AGS-17.

Finally, in September of 1982 Coyne and I found ourselves in a jeep parked outside the shop of gun dealer Hakim Gaz in the village of Darra Adam Khel, weapons mecca of mid-Asia — 40 clicks from Peshawar and well within the forbidding Tribal Lands on the border between Pakistan and Afghanistan. Here, *pukhtunwali* (tribal law) prevails once you step off the road. At that time closed to foreigners for

Only a minor scoop. First picture of tripod of Russian lightweight 12.7mm heavy machine gun taken in Darra in December 1988. Photo: Jack Thompson



more than a year because of a large drug bust at the local heroin factory, Darra Adam Khel overpowered all the senses and my memories of this small village with its narrow, congested main street are still vivid.

The ear was attacked most brutally with incessant gunfire, as customers of the ubiquitous small gun shops stepped out into the street and test-fired weapons they were interested in, aiming directly into the burning sun above. The gunfire was interspersed with the almost constant honking of horns as vehicles of all descriptions swerved in and out on direct collision courses with sheep, people, cattle, vendor's stands and trucks painted in the most garish style imaginable.

First photo published of French antitank Milan missile somewhere in Afghanistan. Brown carries Soviet Dragunov sniper rifle. He's on the left, by the way.

The sense of taste was overloaded and finally dulled by raw onions, harsh cigarettes, half-ripe tomatoes, Coca-Cola, heavily spiced lamb kebab and mint tea. The smell promoted turbulence in the gut — the odor of human and animal wastes, vegetables, fruits, spices, hashish, sweat, the gasoline engine's poison vapors, the primitive gunsmith's hearth and above all the acrid smell of gunpowder. This mélange assailed the eye as well, reinforcing the frenzied messages being sent without interruption to my brain.



EMBASSY OF THE
UNITED STATES OF AMERICA
Defense Attache Office, Islamabad, Pakistan
Department of State, Pouch Room
Washington, D.C. 20520

22 January 1981

U-035-81

TO:

Lt Col Robert K. Brown, 315-30-9054
U.S. Army Reserve
P.O. Box 693
Boulder, Colorado 80306

SUBJECT: Letter of Appreciation

1. I would like to express appreciation for your outstanding service to the United States of America. Through your efforts, the U.S. Government has gained significant insights and better understands the military capabilities of potential adversaries. Your efforts are greatly appreciated.

2. Your aggressiveness and steadfast determination in the face of considerable obstacles exemplify the characteristics essential for officers and leaders. You can be proud of the contributions you have made.

3. Again, please accept my thanks and appreciation for your efforts.

4. Request a copy of this letter be inserted in your personnel folder to document the significant contributions you have made.

Harold A. Mauger, Jr.
HAROLD A. MAUGER, JR.
Colonel, U. S. Air Force
Defense and Air Attache

Letter of appreciation Brown received from U.S. Defense attache after delivering 5,000 rounds of AK-74 ammo (see page 79).

Twice before we had been wedged into the back of a mujahideen jeep and smuggled past the Pakistan army checkpoint. On each of these two previous trips we were told the AGS-17 was still not available, that we should return in a few days and *Inshallah* (God willing) it would be there. Due to our schedule, this was to be our last attempt.

I held little hope for success. Hakim Gaz's glassy-eyed vagueness and lack of enthusiasm kindled little expectation that we would ever lay eyes on an AGS-17, let alone fire one. Eventually we were invited inside the gun dealer's shop, where we sat for a half hour sipping Coca-Cola until a man appeared, silhouetted in the doorway, struggling to bring an AGS-17 inside.

Its presumed part-owner followed and we were immediately told that we could not fire the weapon until we returned with the cash to purchase it — \$45,000. The corpulent, red-faced, orange-haired owner left and Hakim Gaz, who had said nothing during this interval, asked me how many rounds I wished to fire through the AGS-17. I told him 40, a not inconsiderable number as they were \$20 per round.

That settled, we piled into the jeep and followed Gaz to a small rural village several miles deeper into the tribal area. It was nestled against low-lying hills and steep bedrock escarpments that would prove to be our targets. The AGS-17 was

set up by a gunsmith Gaz had brought with him facing the sheer cliffs about 400 meters away. Forty rounds later we had completed the test and evaluation which was to become the first in-depth open source report on the *Avtomaticeski Granatomojot Stankovi* (See "Raiders of the Lost Grenade Launcher," February '83).

The trip of September 1982 was to result in three additional intelligence scoops for SOF. While examining material in a mujahideen arms depot in Peshawar, I encountered an RPG-18, essentially a Soviet copy of the U.S. M72 LAW, about which little was known at the time. Hidden behind a pile of rotting .303 British cartridges and WWII-vintage No. 36 Mills grenades, we were able to

examine it in detail and publish the first clear photos ever taken of this light antitank weapon in our report (see "USSR's Great Leap Backward," February '83).

While SOF had uncovered the AKS-74 rifle and its caliber 5.45x39mm ammunition (around which much confusion and wild speculation had reigned) in Pakistan in 1980 (see sidebar), it was not until September 1982 that we were presented with an opportunity to perform the first detailed test and evaluation of this weapon ever conducted outside of Mother Russia.

Once again I found myself stuffed into the red jeep, this time on the road to a mujahideen training camp near the Afghanistan border. Three mujahideen who rode with us were armed with a curious mixture of weaponry: a Tokarev pistol (the clandestine PRC variant marked "M20"), a rare DWM-marked M1906 Commercial Luger (in caliber .30 Luger), an HK91 rifle (the U.S. import version) and the AKS-74 rifle I had come to examine and test-fire.

We were met at the camp's entrance by guards carrying Egyptian-made AKMs and a P14 bolt-action Enfield (caliber .303 British). A long row of open-sided tents extended the length of the camp's firing range. As I raced to the table that had been set up for me, clutching the AKS-74, I was introduced to Mohammed Kareem, the mujahideen camp commander and a former brigadier in the Afghan army. His magnificent beard and ferocious appearance were enough to qualify him for the cover of SOF. Although Mohammed Kareem proved to be an excellent and cooperative model for our photos, I clearly remember that he was never able to master the AKS-74's trigger

and could not fire anything shorter than a three-round burst. He and I alternated firing the AKS-74 until sundown. By that time we had expended close to 2,000 rounds — without a stoppage and with another SOF exclusive in hand, including a report on the until then unknown dark-brown ABS plastic AK-74 magazine (see "SOF Exclusive: Soviet AKS-74," May '83).

SOF's exclusive T&E of the RPK-74 was another product of this excursion to mid-Asia. Our test and evaluation of the RPK-74, once again conducted at Darra Adam Khel, involved no less than three test sites, the first two of which require some description. Traveling, as ever, in the red jeep, Jim Coyne and I stopped again at the Pakistan army checkpoint and this time picked up an old man I assumed to be a vagrant. A hundred meters past the checkpoint the jeep halted, the old man was handed a 100-rupee note and he departed. Momentarily, I assumed he was a beggar. But I had just been witness to *baksheesh* (bribery). The decrepit, disheveled-looking graybeard was a Pakistani political officer.

Once again, we parked outside the shop

SOF 1, CIA 0 — THE BEGINNING

SOF's AKS-74 Project originated during a meeting in October 1979 between myself and an international arms dealer. In the course of the conversation the arms dealer stated he would pay \$10,000 for one of the new Soviet assault rifles, though there was more curiosity about the round itself. Rumor control theorized that the ammo could include a new flechette, an armor-piercing round, a hollowpoint and a tracer round. But where could SOF get rounds or the rifle?

A good question, as no Western Intelligence agency — including the CIA — had been able to procure an AKS-74 or the round, even though the weapon had been issued to elite Soviet units since 1975.

We speculated that Afghanistan might be the place, due to a growing number of Soviet advisers. But if we obtained one, how could we get it out of Pakistan? The arms dealer replied cryptically, "You get one and I'll send a man to Pakistan who will bring it out and into the U.S." He didn't elaborate. Trade secret, we presumed.

Late in October, Managing Editor Bob Poos, while goose hunting with Galen Geer, discussed the feasibility of sending Geer, who's always looking for a war to cover, to Afghanistan on a dual mission — assess the Afghan war and obtain Soviet equipment. Preferably before the CIA! When we read reports of Soviet airborne units operating in Afghanistan after the 27 December 1979 invasion, our hopes rose. Undoubtedly the Afghan rebels would zap some Soviet paratroopers — and capture AKS-74s and ammo. Off Geer went to Afghanistan.

— R.K. Brown



SOF's Galen Geer found and delivered to the U.S. first AK-74 rounds, scooping all Western Intelligence agencies. Photo: Galen Geer

of gun dealer Hakim Gaz. Once again he had the goods. The RPK-74 was well-worn. It had seen much fighting, but was more than serviceable.

Led by Gaz's brother, we tramped down the street, carrying the RPK-74 and several thousand rounds of ammunition to a vacant lot in the very center of town. I began blazing away at a bedrock outcropping about 200 meters downrange from the rock berm I had rested the bipod on. Apparently the continuous, sustained bursts of fire were too much for even Darra's jaded ears and soon every street urchin in the village was in audience. Between each burst the children scrambled over the berm and raced out in front of the muzzle to retrieve the ejected empty cases. Thirty minutes of this was too much and we decided to move.

We set up again in a meadow on the other side of the village, to the rear of the buildings. Firing into a hill, I suddenly noticed an Afghan hat rising over the crest, directly above the front sight. A face appeared. It was attached to the body of a villager who sauntered into my line of fire, pulling up his pants, as he had just finished relieving himself behind the hill. Somewhat disconcerted, I passed the weapon to Coyne. As he fired, cattle began to migrate across the meadow into the firing zone.

We packed up and relocated once more — this time well outside Darra in a dry wash, where I was able to complete my test and evaluation without further disturbance (see "SOF Tests USSR's RPK-74," September '83).

During this same time frame I was the lucky recipient of two interesting pieces of Soviet militaria via contacts in South Africa. The first was a type of Soviet soft body armor previously unknown (see "Bad News For Boris," January '83). Most amazing were the ballistic panels of this "flak jacket," which consisted of nothing more than plastic bags filled with partially

ginned cotton wadding. Removed from a Soviet army adviser taken prisoner during the Protea raid in Angola, this vest might have stopped almost spent fragments from an HE shell, but little else. The most amusing aspect of this affair was the fact that I paid only \$75 for the vest, but was able to sell it, after we conducted our examination of it, to a U.S. intelligence agency for considerably more than I had invested.

Even more fascinating was the inert (explosive filler and fuze removed) specimen of a Soviet M75 hand grenade that was sent to me. Substantial quantities had turned up in Angola and it appeared to be an exact duplicate of the Austrian Type HdGt 73 made by ARGES (Armaturen-Gesellschaft GmbH), only with Cyrillic markings. Using 2,600 steel pellets set in a plastic matrix covered with a sprayed thermoplastic synthetic, waffle-pattern outer skin, it is an example of the current trend to combine offensive and defensive requirements into a single grenade (see "USSR's M75 Grenade," April '84).

After our article appeared, I was contacted by ARGES who offered to purchase the grenade for a large sum. Expressing



SOF'er Jim Coyne brought out the first Russian PMF-1 antipersonnel mine in 1981. Photo: Jim Coyne

outrage at this blatant pirating of their design, they emphasized their desire to examine the unauthorized copy in greater detail. Five years later I learned that their self-righteous indignation was no more than a smoke screen, when I was informed by South African technical intelligence personnel that, while both the PETN explosive filler and Bouchon-type igniter system were of Bulgarian origin, the body itself was, in fact, manufactured by ARGES through the subterfuge of merely changing the two molded identification markings on the surface of the outer skin (see "Guns of Ovamboland," February '89). Pre-dating such deceit by more than 300 years, La Rochefoucauld commented in 1665 that, "Hypocrisy is the homage that vice pays to virtue."

The Soviets fielded just about every piece of hardware in their arsenal during their years in Afghanistan and SOF staffers scooped it up as fast as Ivan laid it down. The so-called "butterfly mine," also some-

times know as the "green parrot" to the mujahideen, an air-delivered small plastic antipersonnel mine with a liquid explosive, was first exposed to SOF readers in the April 1981 issue. The PMF-1, sown principally by Mi-8 helicopters, with each aircraft usually carrying two 144-mine scattering units, was responsible for the maiming of many thousands of innocent civilians.

In October 1983, SOF Editor/Publisher Robert K. Brown was presented with Soviet body armor liberated by Afghan freedom fighters from a high-ranking Soviet officer who had no further need of it — or anything else for that matter. It featured a Kevlar-type (aramid) ballistic cloth combined with titanium plates. SOF conducted extensive tests on this vest and published its exclusive report in the May 1984 issue. The vest offered protection against little more than 9mm bullets fired from handguns and exhibited pathetic ergonomics.

As a consequence of his frequent trips to Afghanistan, Soviet military authority David C. Isby has provided SOF with numerous intelligence coups. One of his most interesting was an exclusive test report on the Soviet AKR (see "AKR," July '84). Dubbed the "Krinkov," it is a short-barreled version of the AKS-74 rifle. Only 19 inches in length with the buttstock folded, its most distinctive feature is a cylindrical muzzle device which incorporates a bell-shaped flash hider and an expansion chamber to reduce the increased port pressure caused by relocation of the gas block close to the chamber. Asking price in Darra was a mere \$16,000, so Isby traveled to the Khyber Pass where he located a test specimen for analysis without charge.

Other exclusive tech intel reports brought out of Afghanistan by Isby for SOF have included the OG-7 HEAT grenade for the RPG-7, RPO-50 flame rocket launcher,

Over the years, SOF's David Isby provided numerous intel reports including one on the AKM-mounted BG-15 40mm grenade launcher pictured below. Photo: David Isby

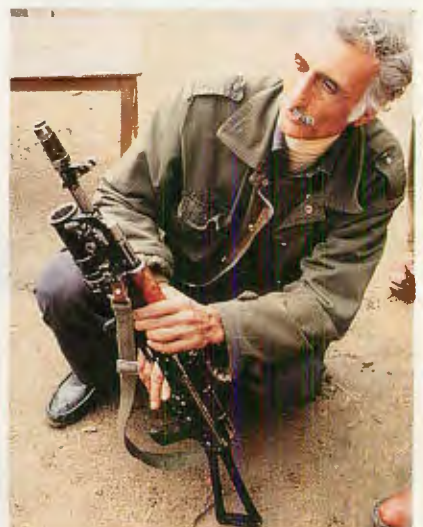



Jim Coyne, above, and Kokalis were first journalists to test fire Soviet AGS-17. Photo: Peter G. Kokalis

Vasilek 82mm self-propelled mortar and a new filter canister for the ShM gas mask (see "Inside Ivan's Army," August '83); a sound suppressor for the AKM (see "SOF Silencer Scoop," August '84); MON-50 Soviet claymore-type mine, rocket-propelled RPG-16 HEAT grenade; flechette ammunition for the 30mm AGS-17 automatic grenade launcher (see "SOF Counts Coups in Afghanistan," October '84); and the AKM-mounted BG-15 40mm grenade launcher (see "Soviet BG-15," July '85).

In 1986 we were invited to the People's Republic of China to test and evaluate the entire spectrum of their military small arms arsenal. The tests were to be conducted at the Small Weapons Research Institute of the People's Liberation Army (PLA) north of Beijing — a weapons facility previously off limits to foreign devils. The most puzzling question was why SOF? Why not any number of prestigious international defense journals? Prior to our trip a wide array of both sinister and bizarre explanations were formulated by our staff and

BELOW: One of SOF's biggest coups was its exclusive invitation to visit the PLA Small Weapons Research Institute near Beijing to test their latest weapons.



ble dissemination among procurement officials and weapons authorities throughout the world. In addition, they wanted me to present a seminar to their engineering staff at the Small Weapons Research Institute.

As friendly as they were, we remained cautious and while in our rooms at the Beijing Hotel communicated via note pads or out on the street in front of the hotel amidst the traffic noise. This proved to be a wise precaution, as I eventually discovered what appeared to be a bug behind the duct grate high up on the wall of my room. Nevertheless, between elaborate two-hour lunches and highly ritualized banquets that included ink fish, sea slugs, ox tripe, chicken feet, fungus, jellyfish, fish bladders, shark fin soup, 1,000-year-old eggs and duck feet, all enhanced with ornately carved garnishes and washed down with unending toasts of Moutai (which to me tasted like Zippo lighter fluid), we test-fired and examined in great detail an amazing assortment of weapons.

All of this resulted in an eight-part series that included exclusive reports on the PRC Type 81 rifle and SAW (see "Guns Behind the Great Wall," September '87), the Type 77 caliber 12.7x108mm heavy machine

several foreign affairs experts we consulted.

Upon our arrival we discovered the answer to be far more mundane, albeit flattering. After reviewing every weapons-oriented publication from international military trade magazines to the popular gun press, the Chinese had determined that exposure in SOF would give their small arms inventory the largest and most credi-



ABOVE: SOF has scored weapon scoops throughout the world. Kokalis was the first to fire and evaluate the Spanish CETME MG82. Photo: Peter G. Kokalis

BELOW: ComBloc ordnance out of El Salvador also added to SOF scoops. Below is first photo of 7.62x62.8mm low-signature assassination cartridge.



"HOW NOT TO MAKE \$1,500!"

After turning over the AK-74 rounds to representatives of a certain government agency (not the CIA), we discussed what kind of deals we could make for the future. They gave me a list of Russian equipment they wanted and a list of prices they would pay for each item. A container of nerve gas, for example, would bring \$250,000; a container of incapacitating gas, \$125,000; an AGS-17 grenade launcher, \$65,000, and so on.

Running around Pakistan with pockets full of money did not seem like a good idea, so I asked if they would pay me, in cash or gold, for each item as I turned it in. This way, I could pay for something from the list with money received from a previous sale, leaving me with little to carry around. Still, I anticipated the Afghans would demand sizable sums of money for any items purchased from them.

They agreed, then instructed me to check in with the Defense Attache's Office (DAO) in the American Embassy to let them know I had arrived. They instructed me to have no dealings with the State Department, as State had tried to take credit for obtaining the NBC filter that Galen Geer had brought out of Afghanistan. No problem, or so I thought at the time. Checking in at DAO, a young nincompoop lieutenant colonel began huffing, "I'll have to contact the DIA (Defense Intelligence Agency) first." And to hell with you, too. "Whatever," I replied. It was time to head back to the local Holiday Inn.

Lieutenant Colonel Nincompoop showed up the next morning to officially tell me, in an officially staccato voice, that, "We will not pay you in cash, and any payment we do make will have to be in the United States. Also, you should not go into Afghanistan, as neither the American ambassador in Afghanistan nor in Pakistan will be able to help you."

I asked the good Lt. Col. Nincompoop what the security was like on the road between Peshawar (where the SOF team was based), and Islamabad, where I had flown in. "The road is secure. There are no checkpoints, no roadblocks, no problems." (I later found that English is the second language of Pakistan. Everybody, including Lt. Col. Nincompoop, says "no problem" and "I understand." The translation for these is invariably, "There is a problem, but I don't understand.")

I flew back to Peshawar where the seven-man SOF team was training Afghans and looking for goodies from the agency list. The agency had offered to pay a dollar a round for an additional 10,000 rounds of AK-74 ammo. But days turned into weeks, and we weren't finding zip. A couple of days before it came time to say

bye-bye, however, our luck began to change.

John Donovan, who had been teaching the muj how to fuse and place land mines, and Jim Pate, our ordnance expert, were able to buy 5,000 rounds of AK-74 ammo for 70 cents a round in Darra. They successfully smuggled the ammo past Pakistani army checkpoints into our hotel in Peshawar, then took off for the States.

Dr. John Peters and I returned after being temporarily "detained" for trying to get into an off-limits refugee camp to find the 5,000 rounds packed into knapsacks, lying on the bed.

Peters and I were scheduled to leave soon, so instead of driving the three-and-a-half hours back to Islamabad, we decided to unload our goodies on the U.S. Consulate in Peshawar, even though we had been instructed otherwise. I mean, we were supposed to be on the same side, right?

I called the consulate, where we had earlier been given the standard dog and pony show briefing, and said we had some items to deliver. No problem. Now it was James Bond time. Taxis were switched, and we constantly checked for a tail.

Our anxiety roller-coastered as the driver "I understand" and "no problemed" us past every army post and police station in Peshawar on our way there. I had no idea how many years in a Pakistani slammer carrying 5,000 rounds would merit, and did not particularly wish to find out.

After finally getting the rounds to the consulate, we breathed a sigh of relief and returned to the hotel. Mission accomplished — or so we thought. At 0730 the next morning, the phone rang.

"Mr. Brown?"

"Yes."

"This is the consulate. I have been informed by my superiors in Islamabad that we cannot accept the goods you delivered. You will have to come and pick them up."

I was very tempted to tell him to take the 5,000 rounds and insert them into the body orifice of his choice, but if he did that, we'd be kissing off \$3,500. Ah, what the hell, I thought...let's taxi it to the U.S. Embassy.

So we hired some Abdul with an old Mercedes and headed out. The anxiety level started creeping up again as our driver 1) had to check his oil, 2) get something to eat, 3) get gas, and 4) find something to drink. On top of this, we had been informed that all taxi drivers were Pakistani police informants. So what do I do if our friend Abdul 5) "has to make a phone call?" Cold cock him or just go quietly to jail?

No phone call was made, however, and we were soon on the road to Islamabad. I relaxed back into the cracked leather seat, until...

"Driver, what's that up ahead there about 200 meters?" I queried.

"Ah, sahib, nothing to worry about, is only army roadblock checking for guns and drugs to Islamabad."

I came out of my seat like a shot. Guns and drugs to Islamabad my ass! It's Brown and Peters to the slammer, and Lt. Col. Nincompoop had said "No problems." I was going to strangle the little son-of-a-bitch when I got to the embassy. I was getting ideas...boiling oil, the rack, bamboo splinters, disembowelment...maybe even make him listen to SOF Technical Editor Kokaliş evaluate the merits of the Thompson and the Sten for a whole day. Ouch!

Over the next three hours, there were five, maybe six more checkpoints like the first one. "Abdul, what is..." I would ask, only to hear, "Oh, no problem, is only being checkpoint for..." My anxiety level was now on white-hot rage. I wouldn't have the patience to torture poor Lt. Col. Nincompoop. I was going to fire 5,000 rounds of 5.45 up his ass in one big glorious burst.

The last roadblock came into view. "And THIS one, driver?" I asked, smoke wafting slowly from my ears. "Ah, to check driver's papers and license. I have neither. No problem." Ah, well, maybe we can con the authorities to send Abdul to jail with us, too. That would be some consolation, anyway.

Strangely, we made it through all the checkpoints. How? I don't know. Maybe Allah does. Maybe the guards just thought gringos in a Mercedes shouldn't be screwed with. At any rate, after getting lost on his way, Abdul finally pulled up at the embassy.

Fortunately, the good Lt. Col. Nincompoop was not there. So the delicately colored Persian rugs would not have to be cleaned of blood stains, and I would not end up in jail, after all.

Colonel Harold Mauger, Defense and Air Attache, greeted us, calmed me down, had the ammo counted, gave me a receipt and promised a letter of appreciation (see page 76). Doc Peters just looked on and smiled. He hadn't cracked a single expletive during the entire trip over. A cooler dude than he I know not. Maybe he had taken some weird Pakistani pills.

So the mission was accomplished. The ammo was delivered and SOF was \$1,500 richer. Was it worth it? Not in your wildest dreams, sahib!

— R.K. Brown

gun (see "Guns Behind the Great Wall Part 2," October '87), and the 7.62x25mm subsonic cartridge (see "Guns Behind the Great Wall Part 3," November '87).

During interludes between our frenzied test schedule, Bob Brown jogged on the Great Wall and I presented my seminar. At one point in my presentation I criticized the practice of chrome-plating bayonet blades

as an undesirable increase in position disclosure. One of the institute's engineers huffily replied that this was done to instill fear in the enemy. Waiting until the end of my presentation to respond, I offered a toast expressing my desire that all of our common enemies be equipped with shining bayonets. In light of the subsequent massacre in Tiananmen Square, I can only hope

that the PRC continues to equip its troops with chrome-plated bayonets.

After our trip to mainland China, officials of Poly Technologies, Inc. proposed that SOF lead tour groups to the PRC to fire weapons ranging from the Kalashnikov to 14.5mm HMGs and RPG-7s at a range

Continued on page 131

FROM AFGHANISTAN, WITH LOVE

General Rahmatullah Safi Sends Thanks to SOF

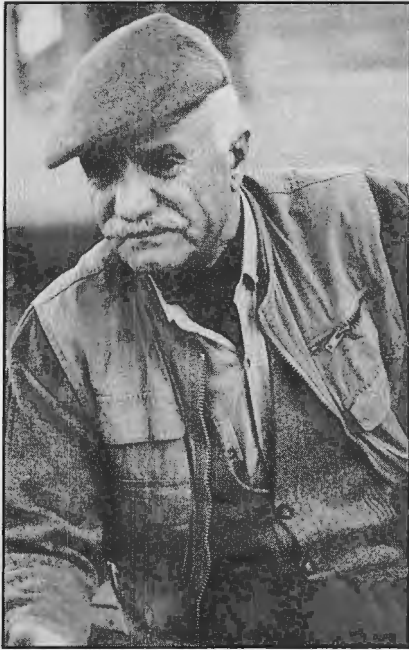

S*OLDIER of Fortune* may not look like a unique magazine, but it is. Other magazines may have more readers, be more useful or more beneficial to their readers. What makes *Soldier of Fortune* unique is not paper and ink, but goals and values. While other magazines are interested in making money, I have seen first-hand *Soldier of Fortune's* investment in freedom.

The story began after the Soviet invasion of Afghanistan. There was a national uprising — everyone was fighting — but little organization. Lack of discipline, training, weapons and tactical understanding resulted in high losses.

I thought that the best way to reduce our losses (and increase the enemy's) was if the Soviets were planning for a 10-year war, we should be ready for a 15-year war. We had to improve the quality of our training — quality more than quantity. I, as a mujahideen commander, asked Pir Gailani, the leader of my party, to establish a training camp. Before this camp was established, we had thousands of mujahideen in camps, out of action but not receiving useful training. They were in camps because they could not stay in Afghanistan year-round, or because of weather, or because they needed resupply. I wanted to train them when they were out of Afghanistan.

The training was difficult. We lacked resources and equipment. Even subjects such as commando and guerrilla tactics, special demolitions, and close-quarter battle had to be treated as theoretical subjects, or could only be practiced with great difficulty.

The first sign of improvement came when mujahideen commander Wakil Ackbarzai, head of our refugee department, brought an American named Jim Graves, of *Soldier of Fortune*, to inspect the training camp and discuss our needs, not only for training and support but also for modern communications (at the time, we mainly used runners or mounted couriers) and minefield clearing equipment.

After this, I was invited by the Washington-based Committee For a Free Afghanistan to visit the United States. They, like the people from *Soldier of Fortune*, had three major tasks: first, to make the American public aware of the situation in Afghanistan — building public opinion; second, to find humanitarian aid for Afghans; third, to make the United States government pay attention to the Afghan cause. During that trip, I was asked to visit *Soldier of Fortune* in Boulder, Colorado. I talked about the war in Afghanistan. *Soldier of Fortune* then provided me with small numbers of mine detectors, radios, binoculars, and cash for training equipment. This was at a time when the idea of military aid for Afghans could only be whispered in Washington. These gifts from *Soldier of Fortune* were the first mine detectors to reach the Afghans.

The second time I came to the United States, the political situation was different. In the government there were basically three teams working for Afghanistan. In the White House, there was Dana Rohrabacher and his friends to push the President; Senator Gordon Humphrey pushed the political side and Congressman Charlie Wilson pushed the military side with his right-hand man Charlie Schnabel in the field.

But I still needed the help of my friends, such as *Soldier of Fortune* and the Committee For A Free Afghanistan. *Soldier of Fortune* has been continuously helping the success of our jihad. It is not only me, but many commanders, and many parties, that have been helped. *Soldier of Fortune's* people inside Afghanistan sent back reports that helped push the government to help.

Finally, there has been unimaginable and unbelievable success: the collapse of the Soviet empire. While its fruits are seen in eastern Europe, it began in Afghanistan. While their role was perhaps small, *Soldier of Fortune* played a part. I respect their fight against communism, their understanding of the difference between right and wrong, and that they never lose hope (unlike some others). *Soldier of Fortune* has always believed that, at the end of the day, right will win, wrong will lose, and it is worth it to sacrifice for freedom. If you believe in freedom and democracy you will, sooner or later, win. That is *Soldier of Fortune's* goal and belief.

Soldier of Fortune has showed itself to be unique, throughout the war in Afghanistan, by being willing to give money and resources to help the Afghans as well as paying money to send many fine writers and photographers to report on the situation. For that reason I — and my fellow mujahideen — will forever be grateful. ✕



*National
Islamic Front
of Afghanistan*

IN MEMORIAM

CRAIG NUNN

1947-1989

Farewell to a Brother in Arms

by Jim Graves

A stranger scanning the crowd of 200 to 300 mourners outside the funeral home would have had some difficulty figuring out what sort of person could have touched the lives of so many different people.

Side by side, a hard-bitten lot of journalists, old soldiers turned mercenaries, bikers, exotic dancers, policemen and professional football players drifted to and fro among the yuppies, runners, accountants, lawyers, dentists, doctors, artists and musicians — one and all fighting back tears.

They had gathered for Craig Nunn, *Soldier of Fortune's* art director since 1979, killed in a motorcycle accident in September 1989.

Depending on who they were and their association with him, people remembered Craig as a talented professional artist and the office prankster, a proud Special Forces veteran and parachutist, a jovial hard-drinking biker buddy who subscribed to a Christian biker magazine, a fanatical athlete, a lover of classical music, a railroad modeler, a cinema buff and an exuberant sports fan (Iowa Hawkeyes and Denver Broncos).

Nunn the Hun (he came from German stock around Amana, Iowa, and admired their uniforms) stories number in the thousands among SOF's old-timers.

In his art director mode, Craig would plug in a headset, put some Mozart, Bach or Wagner's "Flight of the Valkyries" on his stereo, hang his "Do Not Enter On Pain Of Death" sign on his door closing out the world while creating striking layouts from sometimes marginal material delivered to him more often than not at the last minute. As managing editor, I often held pages open until the last possible moment, knowing Craig would get us back on schedule. Under deadline pressure, Craig's intensity and concentration were forces not to be taken lightly.

Once deadlines were past, Craig sought out entertainment, physical exercise, fun and targets for mischief with the same

intensity.

Craig's interests were diverse, and he had a knack for bringing together people who under normal circumstances would probably not even nod to each other when passing on the street.

Prior to coming to work at SOF, I never spent much time around characters like Mouse, Big Pete and Little Pete, Byron the Biker and Stephen the Heathen. Thanks to Craig, I've pounded down enough beers with the bikers in bars and at parties to discover that, while their world's not mine,



they come in good and bad, just like all other people.

During his fitness crazes, Craig hounded friends and staff to get involved in exercise and sports.

He was SOF's instigator, prime designer, builder and strongest competitor in Boulder's Kinetic Conveyance race. Each Spring the human-powered vehicles are raced more than 4 miles over hills, through mud flats and across a lake in a contest known for outrageous costumes and gen-

eral tomfoolery. His last vehicle, officially the Mekong Delta Yacht Club entry, complete with guns on the prow won raves for design but broke up in the water and sank.

I will never forget Craig's Wolfen Brigade. A serious cross-country skier, he fired up a group of impressionable staffers on winter sports, hiking and camping. Hours and hours were devoted by Craig and his gang to spelling out requirements for membership (x-miles cross country skiing, x-miles on snow shoes, etc), planning exercises into Colorado's mountains, and in design of uniforms, patches and certificates.

SOF's annual New Year's weekend trip to Steamboat Springs doubled as the coming out operation for the Wolfen. The -20 degree temperature, lowered to -brrrrrr by a stiff wind, had the rest us off the slopes and tucked inside the lodge. The Wolfen suited up (white smocks of Craig's design remarkably similar to some worn by German alpine troops in WWII), strapped on their snow shoes, plunged outside, marched around the house twice and were led back in by Craig for beer, chips and Elvis movies. He took endless and unmerciful kidding on that one, but we never got more than a sheepish grin for our efforts.

Craig was always ready to stand in the door and picked up Israeli, Guatemalan, Nationalist Chinese and Salvadoran wings to go with his Army airborne set. Early in the 1980s Craig organized a ground school and novice jump for a bunch of SOF's friends — principally the staff from our local watering hole, bikers and ROTC jocks from the University of Colorado — to give them a little taste of fear and adventure. With some difficulty, a DZ was arranged in the rolling farm country east of Boulder. Driving from the airport toward the DZ marked on my local map I saw a chute being blown rapidly off the DZ and right into a subdivision.

I pursued the chute until it dropped out of

Continued on page 110

DANGEROUS LIAISONS

Text & Photos by James Renner

“THE warning came late at night — we must leave immediately, we were told. According to the mujahideen’s intelligence sources, the Soviets knew we were there — Soviet troops would be landed on the surrounding mountains in the morning.”

It was summer 1986 and journalist Julian Gearing and a colleague had been in the Kheilab Valley, Takhar, for 10 days, interviewing Commander Massoud.

“We grabbed our cameras, bundled our gear into a waiting jeep, and set off in the dark. Sure enough, at six in the morning, the jets came in. We could see the helicopters circling. Although we were out of the main area of attack, a Soviet MiG came in and dropped two bombs. Bomb fragments landed within feet of where we dived for cover. We fled the area.”

Today, four years later, the Soviet occupation of Afghanistan is just a memory. But, as the recent death of a French doctor graphically illustrates, the dangers for Westerners venturing into this strife-torn country remain all too real.

Afghanistan shot to the West’s attention at Christmas 1979 when Soviet troops crossed the Amu Darya River in an attempt to secure a bright communist future for the country. Ten years later the results are staggering. Over a million Afghans are estimated to have been killed, untold numbers injured, and five million forced to become refugees — a third of the population. Yet, partly because of the difficulties involved, the full story has never been told. The Western media backed away from the conflict.

For the relatively small hard core of mostly freelance journalists, photographers and cameramen who did make the effort, taking risks was part of the game. With the heavy restrictions placed on covering the Soviet aspects of the war, most were forced to trek clandestinely for hundreds of miles over the mountains with the mujahideen to get a story. Faced with the threat of attack by the Soviet and Afghan armies, the complexities of the ethnic, tribal and

political grouping of the guerrillas, and often operating in harsh terrain, reporting was a real test.

As Peter Schlueter, photographer for the *Arizona Republic*, learned the hard way, death can be a hair’s breadth away. In 1985, while traveling with Charles Thornton, a journalist working for the paper, the men were caught in a Soviet ambush.

“We were riding along, traveling south, when off to the west came a volley of fire,” recalled Schlueter. “I dove off while the truck was still moving, crawled about 15 yards on my belly and turned back to look at the truck. Nobody was there. I was all alone and could see a couple of people running. All of a sudden it started raining explosive devices around us. They landed around the truck, near to me, ahead of me.” Amidst the confusion, Schlueter managed to crawl out of the area and eventually flee to Pakistan. Thornton didn’t make it.

There is no doubt Thornton had been killed. Yet the United States State Department refused to comment. Their excuse: as no body was found there was no evidence that the incident took place. Official sources indicated that even if the body had been received it was unlikely that a diplomatic protest to Moscow would have been made. The State Department, as a matter of policy, wished to discourage Americans from entering Afghanistan. They wanted to avoid responsibility for any American casualties.

Orders To Get Westerners

Westerners were clearly targets. During intensified Soviet bombing and ground offensives directed against Afghan villages in 1984, it was obvious that the Soviet forces were out to hammer the mujahideen and their civilian bases of support. But they also had orders to get Westerners.

If there was any doubt it was dispelled at a press conference in Pakistan in 1984. Vitaly Smimov, then the Soviet ambassador to Pakistan, made the Soviet view stridently clear: any journalist caught ille-

gally in Afghanistan would be eliminated. Westerners were a legitimate target.

Moscow and Kabul’s line was simple. Any Westerner caught in Afghanistan was a spy or a mercenary. Moscow desperately needed proof to back up their fiction that Afghanistan was fighting a war against “Western imperialist aggression.” Westerners could be used in their propaganda war if captured alive — dead, they served the same purpose.

Two years after the death of Thornton, more Americans, this time a film crew, Lee Shapiro and Jim Lindelof, were reported killed in Paghman, northwest of Kabul, when traveling with a mujahideen group belonging to Gulbuddin Hekmatyar’s Hezb-i-Islami. Reports indicated they had been caught in a Soviet ambush.

The American Consul in Peshawar, however, was not convinced that this was the true story. Told by Hezb that the film crew had been killed in a Soviet bombardment, the story was later changed to “an ambush.” Despite his reservations, and those of others, the blame was laid at the door of the Soviet military.

Only when the fuss had died down did something approaching the real story emerge. According to intelligence sources there was in fact no record of a Soviet attack at that time in the area. The evidence, however, indicated something, in a way, more worrying. The men could have been caught up in a firefight between Hezb-i-Islami and a rival party, Jamiat Islami. Today they are still missing, presumed dead.

But it wasn’t until just before Christmas of 1987 that real concern was voiced that

After escaping from Soviet heliborne offensive, CBS TV crew walks down from top of Kantiwar Pass enroute to Pakistan.

INSET: Slipped or was he pushed? The grave of Polish-born Australian, Lech Zondek, in Nuristan. In 1984 he was reportedly training mujahideen in climbing when he fell from a cliff. Grave was later desecrated and cross torn down.

*Caught Up in Afghanistan's
Tragedy, Westerners
Pay the Ultimate Price*

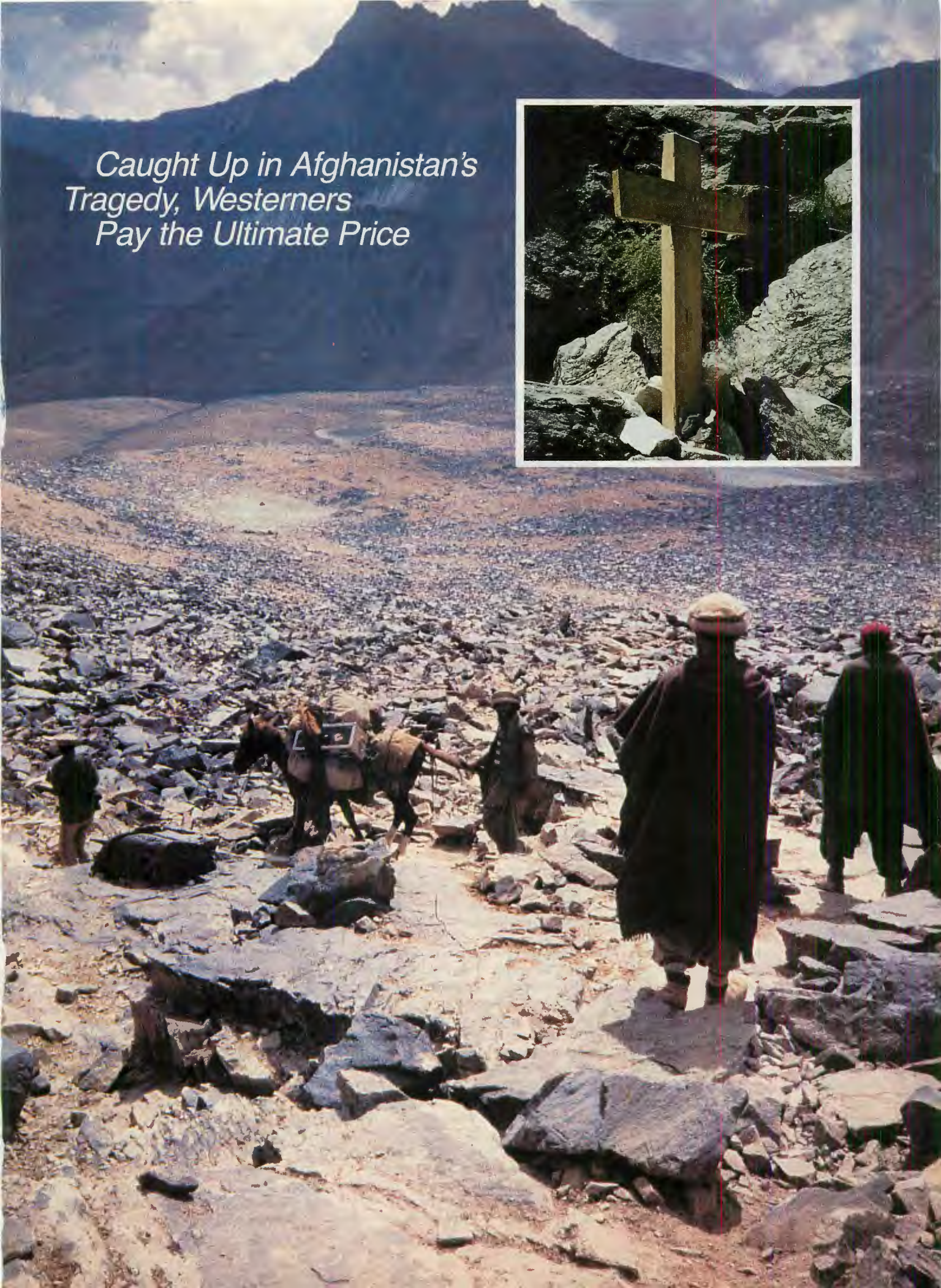



CBS TV camera man, Peter Jouvenal, grinning — and under arrest — at a border post in Chitral, Pakistan, 1984. This was ninth time he had been arrested.

police, but as Pakistan has no jurisdiction over Afghanistan, they were later released.

Hezb-i-Islami was in for some flak. Causing problems for Westerners proved a counter-productive policy. The death of Skrzypkoviak focused attention on other incidents: the holding up of aid workers and journalists, the theft of aid money, the suspected murder by Hezb of a French aid worker, Thierry Niquet.

To combat the mass of publicity and resulting controversy over their role in the

BELOW: Western aid workers take shelter from Soviet bombing in a drilled tunnel, Kheilab Valley, Takhar Province, 1986.



British cameraman Andy Skrzypkoviak (left) with Commander Massoud in Panjshir Valley. All evidence points to Andy having been killed by men working for Hezb-i-Islami in October 1987.



the dangers for Westerners were not solely posed by the Soviet and Afghan regime forces. Andy Skrzypkoviak, a well-known and respected British cameraman who had traveled more than a dozen times with the mujahideen, disappeared on his way to the Panjshir Valley to film leading commander, Ahmad Shah Massoud. The story was unclear. First reports indicated he had been shot by a Hezb-i-Islami mujahideen group near the village of Kantiwar. Hezb leader Hekmatyar, was quick to deny this.

However, Skrzypkoviak's wife Chris Gregory, a photographer with experience in Afghanistan, was able to piece together the story with the help of Western intelligence sources. Hekmatyar had sent orders to some of his commanders to hold up and cause problems for Westerners traveling to areas controlled by his rivals, Jamiat Islami, and specifically those of Massoud. One month before Skrzypkoviak disappeared, Hekmatyar's men at Kantiwar were following orders when they held up journal-

ist Julian Gearing and his party at gunpoint. After stealing his films and tapes, they beat up his guides. Gearing and his party managed to escape in the night.

Skrzypkoviak wasn't so lucky. While the orders did not go as far as killing Westerners, the men Hekmatyar had employed to control the route through Kantiwar were "little more than criminals," as one journalist put it. Thought to be ex-Khad, Afghan secret police agents, and sworn enemies of Massoud, they exceeded their orders.

According to a confession made by one of the men when they were picked up by the Pakistan authorities after entering Pakistan, Skrzypkoviak was held up near Kantiwar Pass, after he had slipped through the village at night. He resisted, but was forced to return. By the time he had come down off the mountain he was extremely tired. He demanded that he be allowed to sleep. Once asleep, the men debated and a decision was made. They dropped a boulder on his head while he slept.

Skrzypkoviak's body was buried away from the main track. A report indicates it was later moved. The body has yet to be recovered. The men thought responsible were held and questioned by the Pakistan



Tough work — Edward Girardet, on assignment for CBS TV News, starts ascent of Kantiwar Pass, Nuristan, 1984.

war, numerous denials followed, including an editorial in their magazine, *The Resistance*. In it they accused well-known journalists of being "enemies of Islam" who wanted to "discredit Hezb-i-Islami" and made it appear like a "terrorist" organization.

But as most journalists realized, rivalry has always been a fact of life in Afghani-

stan. The necessity of traveling with representatives of one particular party could mean problems if you bumped into a rival group.

"It is a shame that relatively small numbers of extremists can tarnish the image of the mujahideen," stated one Western observer. "Over the years, most mujahideen groups, though at times somewhat disorganized, have proved helpful and accommodating to journalists."

While many mujahideen groups have been good hosts, a few have not been keen to hold out a hand of friendship to Westerners. As British TV cameraman Ken Guest found out to his cost, Afghan Shi'ite Muslim groups with pictures of Ayatollah Khomeini nailed to their front door are not always pro-Western. Arrested at gunpoint and deserted by his mujahideen guides, he was locked up in a room to await his fate. Not keen on surprises, Guest escaped during the night, fleeing to the Pakistan border.

Similarly, in 1989 — with the mujahideen's offensive against the eastern city of Jalalabad stalled — a group of journalists were roughed up and detained by mujahideen seemingly unhappy about the critical coverage they had been receiving in the world media. After a nerve-wracking afternoon spent in the company of these trigger-happy men, they were eventually released.

Muslim Fundamentalists

Added to this, a new danger arose. This was the presence of Muslim fundamentalists from countries in the Middle East — and from the United States — who had come to fight an "Islamic Jihad," or Holy War. Mostly Arabs of the Wahabi sect, their hatred of anyone non-Muslim — communists or Westerners — has been made plain on a number of occasions. Journalists have been threatened and beaten up. A Red Cross vehicle was shot at. One English speaking Palestinian encountered on the Pakistan border by a British cameraman made his feelings clear — "If we see you in Afghanistan we will kill you."

"It is really frightening to meet these people. They are the sort of fanatics who blow up planes or plant bombs in airports," said American cameraman Tom Woods, who was threatened by Wahabis.

The death in spring 1990 of the French doctor, Frederic Galland, working for *Medecins Sans Frontieres*, however, drives home the message that aid workers are as much at risk as journalists. Doctor Galland was shot down in cold blood by four gunmen in his hospital near Faizabad, in Badakhshan. Motive unknown. At around the same time, gunmen burst into the house of two French doctors in Ghazni Province, tied and blindfolded them, and then looted the premises.

Being under threat was nothing new. Aid workers have long been in the firing line. As early as 1981, French-run hospitals were reduced to rubble by Soviet forces. There was no doubt the operations were

specifically targeted.

In 1983 Soviet forces swept in by helicopter and captured Dr. Philippe Augoyard, a French pediatrician who was on a mission for *Aide Medicale Internationale* in Logar Province near Kabul. Two other doctors evaded a week-long search of the area.

Dr. Augoyard's Trial

Augoyard's trial proved to be more than just hype. It was a classic example of fiction molded into communist propaganda. Augoyard — under threat of death — was forced to admit at a televised press conference in Kabul that his organization may have been working for the CIA and other Western intelligence organizations. The result: a jail sentence of eight years. Only after an exhaustive campaign by Paris-based medical organizations lasting months was he finally released.

As British doctor, Simon Mardel, pointed out, spending a lengthy period in Afghanistan had its risks — "Our team of two doctors and two nurses ended up traveling nearly a thousand miles, mostly on foot. At one stage we were chased for days by Soviet forces who were quite obviously informed of our whereabouts." They escaped.

But the dangers are not just inside war-torn Afghanistan. Close to the Afghan border lies the Pakistan city of Peshawar, a major crossroads in the history of Asia. This is the home for a large number of Western expatriates working in the refugee camps, running cross-border aid programs, or involved in development work in Pakistan. Over the years the number of expatriates has risen dramatically. Today the majority are Americans. And it would appear that they are now very much in the line of fire.

During the war bombs ripped apart buses, bus stations and markets in Peshawar as the conflict spilt over the border. The communists in Kabul spent a lot of money sowing death and destruction in Pakistan. Through their operatives in Khad, the secret police, many innocent civilians, Pakistani and Afghan, have been slaughtered. Afghans have been gunned down on the street, or on their doorstep. Many have just disappeared.

Now, in the present climate, death for Westerners could be around the corner. For the recent attempt to kidnap an American citizen on the streets of Peshawar indicates, the boundaries are changing. Afghans are not the only target of attack.

The dangers are increasing for Western aid agencies, who are, in effect, sitting ducks for communist agents, or for extremists of any political color. Those working to help Afghan women have become particularly vulnerable to attack. In spring 1990 a mob of Muslim fundamentalists attacked and burned down a center run by Shelter Now International where women could learn to read the Koran and sew. Elsewhere, Western aid workers have been shot at and harassed.

Fearing American casualties, the U.S. Consulate has issued warnings of the dangers and suggested tightening up on security. Most, if not all, American-run offices and houses now have Kalashnikov-wielding guards on the gate. European agencies have been prompted to follow their lead. Yet, as any security service knows, there is little that can be done to protect personnel from a serious attack, especially while out on the streets of Peshawar. As one American aid worker pointed out, "Over the years we have received threats — now, I think, we have to take them much more seriously."

Under pressure, some aid agencies are backing away from the conflict. Experiencing problems in obtaining funds as Western governments lose interest, and with lowering staff morale, numerous aid workers have pulled out. Journalists, too, have begun to move on, mostly because there is less world interest in the story, but partly because of the heightened risks. "I don't like guns being put to my head," stated one cameraman, speaking from experience.

As one Western diplomat, based in Pakistan explained, "We had always been under the impression that the people causing problems were spies and infiltrators working for the Afghan regime or the Soviets. Now, unfortunately, the situation is not so clear cut. Muslim extremists are involved, as are left-wing circles in Pakistan."

Nobody is under any illusion that working in this part of the world is risk free. But the security situation is deteriorating. And as it does so, the list of victims grows longer. Since the war began, seven journalists and four aid workers have been killed — a toll which includes three Americans. Numerous journalists and aid workers have been captured and locked in jail in Kabul. A few have been held hostage by the mujahideen. Hospitals have been bombed. Aid workers and journalists have been shot at and harassed. And one Canadian aid worker operating in Peshawar has vanished.

For the French medical organization, *Medecins Sans Frontieres*, it was the recent death of doctor Frederic Galland that was the final straw. They have decided to pack their bags and leave.

As one experienced Western observer pointed out, "If *Medecins Sans Frontieres* has pulled out of Afghanistan it's a bad sign. They have always been at the forefront of aid work in Afghanistan. I fear that this could just be the beginning. Who will be the next victim?"

James Renner is a British journalist who has specialized in the war in Afghanistan since 1981. He has made numerous extensive journeys with the mujahideen, has worked for American and British television networks and has had articles published in American and British publications. He is or has been personally acquainted with most of the journalists and aid workers mentioned in this article. ☞

AO: FOREST OF ASSASSINS

SEAL Whiskey Platoon Launches into Delta for POW Rescue

by Steven Edwards
Photos Courtesy of the Author

TODAY the legends of U.S. Navy SEAL (SEa, Air, Land) commando operations in Southeast Asia are legion. Those who have heard some of the stories and remember General William Westmoreland's comment about SEALs being the "most effective fighting force in my command" would be surprised to learn that SEALs damn near had to fight their way into the fighting.

U.S. Navy SEAL teams were commissioned 1 January and 3 January 1962 with Teams One and Two assigned to the West and East Coasts, respectively. Within days, Team One had dispatched a platoon for training South Vietnamese SEALs (LDNN) for clandestine raids into North Vietnam, but for four years that was the total SEAL commitment to Vietnam. By early 1966 both teams had new COs and both were chomping at the bit to get into the fight.

There were several problems. The SEALs had been commissioned to conduct small unit unconventional warfare in a maritime environment. Nobody

in the Navy, outside of the SEALs, knew what that meant; and if they did, they did not know how to apply it to Vietnam. The other problem is one that has always plagued elite unconventional units — prejudice. When officers of the regular Navy thought of the SEALs, they thought of prima donnas. Some of the criticism along these lines was not undeserved.

The SEALs descended from the Underwater Demolition Teams of World War II. The teams were conceived with very specific tasks in mind, such as clearing the Normandy beaches prior to the invasion. There was no intention for this to be a

continuing commitment and capability after the war. In fact, it was not until the early 1970s that a career path was designed within the Naval Special Warfare specialty.

By early 1966 Lieutenant Jim Barnes, who was the second CO of SEAL Team One, had made a proposal to COMUSMACV (Commander, U.S. Military Assistance Command, Vietnam) to use SEALs in the Rung Sat Special Zone (RSSZ). The RSSZ, also known as the Forest of Assassins, was critical to the continuing war effort from South Vietnam because the RSSZ could control the approaches to Saigon through the Long Tao River since Saigon is approximately 50 miles inland. The problem was that the

Barnes would form the base for standard operating procedures for the platoons that followed.

It became clear that the standard SEAL deployment period of six months was perfect because of the intensity of operations. Each platoon should attempt to do 60 operations in a six-month deployment, although this was considered really humping it. The SOP for a SEAL platoon during operations was for half (a squad) of the platoon to go out for night ambush, prisoner snatches, etc., while the other squad stayed back and rested but was ready to act as reserves if needed. Barnes and his team learned many secrets on how to battle a wily foe like the VC on his home turf

— the swamp at night. But one of the most important lessons involved methods for developing intelligence. In fact, it was from this first deployment that Barnes expounded the dictum that the single factor that could most affect the success of a SEAL platoon was the development of intelligence.

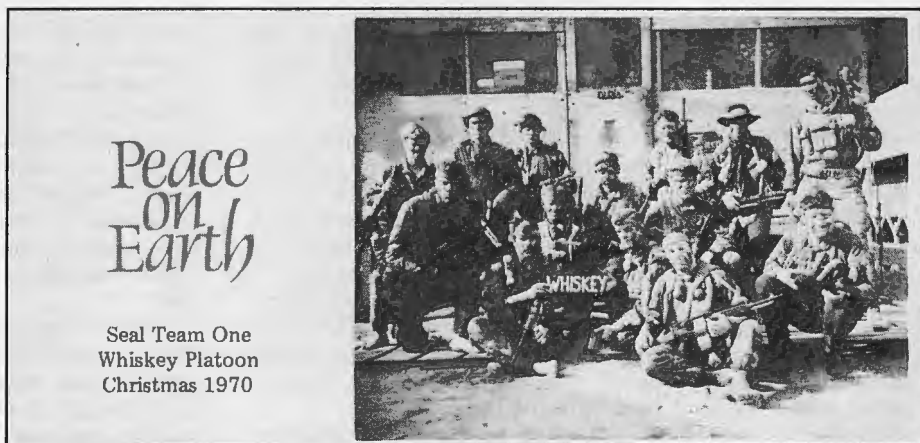

Members of Whiskey Platoon sent out this card during their Christmas in Vietnam, even Nixon got one.

RSSZ was a difficult operating environment with dense mangrove swamps and was an area conceded to the VC.

Lieutenant Barnes and his team of three officers and 12 enlisted deployed to South Vietnam on 19 February 1966 and initially set their operation up at Vung Tau at the mouth of the Long Tao river. This would be the one and only time that the commander of one of the SEAL teams would deploy to South Vietnam with one of his platoons while leaving his XO in charge of daily operations at Coronado Naval Amphibious Base, California. From this deployment, the Lessons Learned file written by Lt.

Ironically, Barnes had specifically precluded the use of intelligence developed from South Vietnamese or indigenous people because of his fear of mission compromise. This was a very understandable fear but he changed his mind, stating in his Lessons Learned report, "It is essential that Vietnamese Intelligence sources be used whenever possible. Every effort should be made to develop rapport with counterparts in this field and win mutual confidence."

Barnes would eventually see his original

Whiskey Platoon member asks questions about AO.

When the intelligence source was willing to lead the SEALs in, they knew that there was reason for a high level of confidence ...

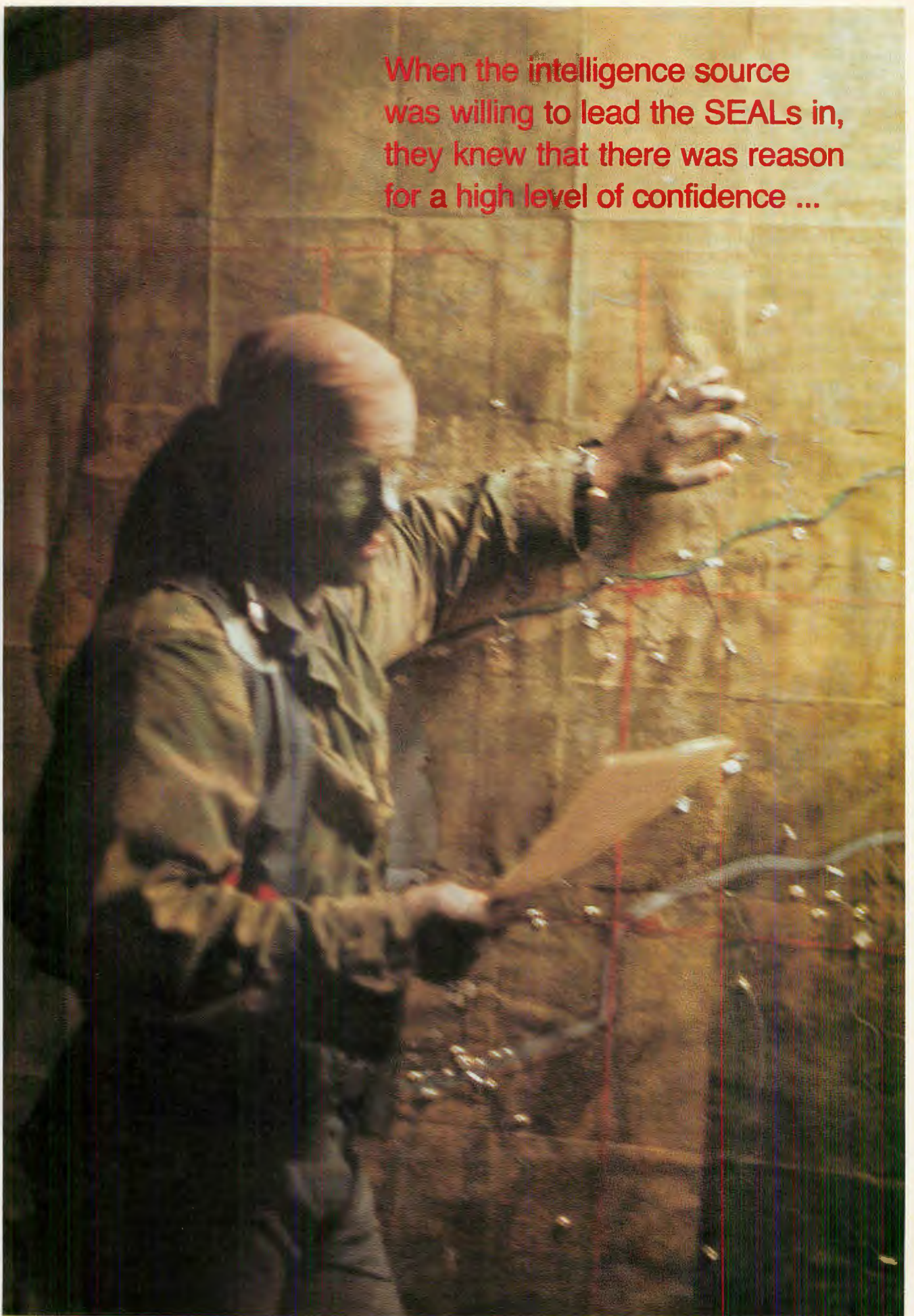

one-platoon detachment — Det Delta — grow to nine platoons covering the entire Mekong Delta including the RSSZ.

Fortunately for SEALs, others agreed with Barnes' vision of the importance of native intelligence. On 23 May 1967 MACV installed the CIA-inspired Civil Operations and Revolutionary Support Organization (CORD) with responsibility for pacification efforts in Vietnam. One program installed by Robert Komer, CORD's director, was the *Chieu Hoi* or open arms program. The *Chieu Hoi* program encouraged members of the Viet Cong Infrastructure (VCI) to rally or defect to the allied side. Many did and became invaluable sources of intelligence.

SEALs would visit provincial *Chieu Hoi* rallying centers to interview the ralliers (*Hoi Chanh*) as potential scouts for SEAL missions in the Delta. The *Hoi Chanh* was free to do what he wanted but life as a SEAL scout (called Kit Carson scout) was not bad. They got free room and board and were well paid by the platoon leader. SEAL platoon leaders learned early on that Vietnamese piasters, drawn from the Naval Operations Support Group at Binh Thuy and signed for by the Kit Carson Scout (KCS or Kit), could produce real results if used effectively. By the late '60s and early '70s most Kits working with SEALs were as accepted by the SEAL platoon as the rest of the SEALs. Kits ate, drank, slept and fought next to their SEAL platoon. This relationship became even more important as SEALs were increasingly asked to perform "Bright Light" missions.

Bright Light was the code name for operations mounted to rescue American prisoners of war. American leaders during the latter portion of the '60s expressed their concern for American POW by ordering that intelligence relating to them be exploited fully. This meant that an operational unit like a SEAL platoon had only to label a mission Bright Light to secure any assets (helicopters, boats, etc.) they needed. In practice, this could often result in a circus-like atmosphere since everyone wanted to be part of a successful Bright Light op. In at least one instance a major was flying an observation helicopter normally flown by a warrant officer.

It was into this atmosphere that Whiskey Platoon of SEAL Team One deployed to the Republic of Vietnam in November of 1970. Whiskey's Officer in Charge (OIC) was Lt. Richard Couch. An Annapolis graduate, Couch volunteered for SEAL duty after serving as First Lieutenant and ASW officer aboard the destroyer *Mansfield* (DD-728). All SEAL platoons when transferring back to CONUS would have the final task of training their SEAL replacements. It would be up to the OIC of the departing platoon how he wanted to do it, but it usually came down to two methods. The platoon would either fly home while leaving their OIC and a senior enlisted behind to do a week or so of training, or the whole platoon would stay



Photo: R. Walker



Photo: R. Walker



TOP: First of three sampans readies for departure for mission to free prisoners.

ABOVE: SEALs at Coronado Naval Amphibious Base during training.

and integrate a few members each night in a series of operations. (Incidentally, when SEAL platoons went home, they all flew back to Coronado together in their own airplane with their weapons.) The AOIC of the departing platoon, Lieutenant Junior Grade Tom Richards, who would eventu-

ally be commander of SEAL Team One, chose the latter method.

Whiskey Platoon's Area of Operation (AO) was the Ca Mau Peninsula on the southern tip of Vietnam. The base of operations was *Solid Anchor* which at one time was based on barges in the same spot



Solid Anchor was the name for this base along the beach in the Mekong Delta.

on the Cua Lon River and was called Sea Float.

The AO was dominated by mangrove swamps, voracious bugs, 12-foot tides, and VC. At this point in the war the Ca Mau Peninsula was strictly "Victor Charlie" turf except for a few villages. Most of the

base assets had been turned over to the Vietnamese navy with American advisers.

The remaining U.S. direct action forces on Solid Anchor were two SEAL platoons and a HAL-3 (Helicopter, Assault, Light) detachment, known as Seawolves, which were helicopter gunships flown by Navy pilots. The "Wolves" were fearless and many SEALs owe their lives to them. Needless to say, the relationship worked both ways. If word came in that a Seawolf had gone down, some comfort had to be derived from the certain knowledge that every available SEAL was busting his ass to get to the personnel. Rounding out the list of assets was a Boat Support Unit commanded by Lt. Bob Natter, a close friend and Annapolis classmate of Couch's, and six Kit Carson scouts.

It was one of the Kits along with First Class Petty Officer Walt Gustaval, acting as platoon intelligence officer, who contacted a village chief and developed information from a fisherman about a POW camp he had seen up a certain canal.

The fisherman was from a village on the north shore of Square Bay, and he claimed the camp was on the south shore of Square Bay. Square Bay is the notch in the map on the western side of the southernmost tip of Vietnam. The fisherman said he would lead the SEALs to the camp.

This was the kind of information that was music to SEAL ears. When the intelligence source was willing to lead the SEALs in, they knew that there was reason for a high level of confidence in the information—confidence that the camp was there, that there were prisoners, and that it wasn't an ambush.

Soon a plan was developed. The plan was that they would cross Square Bay after dark in the Medium SEAL Support Craft (MSSC) while towing sampans which were to be used for silently paddling up the canal itself for a dawn strike.

Natter used secure communications with the base to clear the team into the area and to secure Seawolf and chopper assistance. The boat crew prepared the MSSC, checking everything from the engines to the ammo bins.

The Medium SEAL Support Craft was

designed specifically for SEAL operations. It was a steel hull of catamaran configuration powered by twin muffled 427 Cobra gasoline engines. The typical Medium would carry two .50 caliber machine guns, two M60 machine guns, and often a General Electric minigun. The Medium could really make "the rubble rumble."

The rescue attempt would be made by six SEALs, three Kits, the fisherman guide, and Couch's Vietnamese interpreter. A second SEAL squad would stand by at Solid Anchor to rappel in by helo if help was needed.

At 2200 the team loaded the boat dressed in typical SEAL fashion: small canteen with drinking tube clipped to shirt lapel, grenades of all sorts (SEALs love grenades), pop-flares, ammunition, and blue jeans. Blue jeans made a lot less noise than



Pointman 3rd Class PO Tim O'Farrell (left) and OIC Lt. Richard Couch (right with Stoner 63A) prior to mission departure.

camies, especially when wet. They carried a number of different weapons including Chicom AK-47s and M16s, while the heavy weapons included the M60 machine gun, modified, shortened and fitted with a flex feed tray for those loud-talking fire-suppressing 7.62x51mm rounds.

Couch carried that favorite

of all SEALs, the Stoner 63A, firing 5.56x45mm rounds at a rate of 1000 per minute. The raiding party rounded out their fashion ensemble with camo face paint.

Three hundred yards from the south side of the bay, the team transitioned to the sampans with the lead sampan holding the fisherman guide, Couch's best Kit and the platoon's point man. The second sampan held Couch and his interpreter along with the SEAL radioman and another Kit. The third sampan held three SEALs and the other Kit.

An incoming tide helped the sampans slip silently into the 15-foot canal, and they were making such good time that Couch was getting ready to order that they hold up to await dawn. Suddenly, there was subdued commotion in the lead sampan. After much heated whispering, Couch determined that they had gone up the wrong canal. To make matters worse, the team had lost radio contact with the MSSC. With dawn now approaching, the pressure was

Continued on page 127



SWAT OLYMPICS



Special Weapons and Tactics Top Guns

by Morgan Tanner

Photos by David Bjorkman, National News Service

WHEN 26 private and law enforcement SWAT teams entered the National Championship of SWAT, they came to stomp the competition.

"We figure we'll do well," says Ralph Marshall, officer in charge of the DOE (Department of Energy) Hanford Patrol from Richland, Washington. "At least place within the top three."

"Our objective is to win," agrees Manuel Almagure, DOE team from Rocky Flats, Colorado. "But the benefits are also talking to other teams and cross training."

But whether the teams officially won or lost, they all profited from learning how stress undermines their physical and tactical fitness. Sponsored by the Institute for Public Service and Police Marksman Association, the competition attracted more than 150 participants from 14 states to its second annual SWAT meet held in June in Gainesville, Georgia.

"That's pronounced Joe-ja," jokes a member of the Indiana Law Enforcement team. "You wanna be in this competition, you gotta be able to say sh-i-t in three syllables."

The Longest Yard

Suiting up for the team vs. team event, the team members from Wolf Creek Nuclear Operating Corp. at Burlington, Kansas, pull on body armor, Kevlar collars, and face masks. The design on their black T-shirts is a sword-wielding paladin with a nuclear symbol and the word *tuebor*, Latin for "I will defend."

"A lot of what we do is like a police department," explained security director John Johnson. "If a policeman fails to do his job properly, you're looking at a few people at risk. If we fail, it might be an entire population area."

The five men load the .38 revolvers that are mandatory in this event with marking or "paint" cartridges — six in the cylinder, 18 in reserve. The only way they can get more ammo during the 30-minute contest is

ABOVE LEFT: Members of DOE (Department of Energy) Hanford Patrol of Richland, Washington, wearing MCPU2 gas masks huddle before competition.

LEFT: Hanford Patrol armed with Beretta 92Fs show some of the tactics for entering a room that won them second place honors in the 1990 National SWAT Championship, the first year they entered.



DOE Hanford Patrol starts simultaneous weapons takedown event.

to scrounge it off their own or the other team's "dead." Ahead of them lies a football-sized field dotted with blue barrels, spindly pines, wooden and block walls, and two cars that will provide cover as they make their way to the other end. Their opponent: Rock Hill SWAT from Rock Hill, South Carolina. Their objective: stay alive long enough to rescue their man from Rock Hill's end of the field and bring him to a "safe" zone.

"Use fire and maneuvers to recover the hostage — dead or alive," instructs Bill Brundson, an IPS instructor and this event's official.

Wolf Creek reviews its strategy: one man will stay behind to guard the hostage they've taken from Rock Hill and bound hand and foot. Meanwhile, two two-man teams will flank the field. Bob Walter, the "hostage" they've given up to Rock Hill, has wire clippers in his pocket and a handcuff key in his mouth so he'll be mobile when his team comes to rescue him.

"Shoot, move, and communicate," Brundson advises. "And remember, you cannot summarily execute your hostage."

Wolf Creek and Rock Hill face off, then Wolf Creek maneuvers forward. According to the rules, a hit to the torso or head is a kill, while one to a limb is a wound that allows the "injured" man to shoot, but not

move. The teams are using the newly released FX™ marking rounds from Simunition. Officially, the range of the .38 ammo is about 40 feet, but the teams are making surgical shots at 75 feet. A hit produces a starburst of red on clothing, and on unprotected skin, a sharp smack and a welt.

"When they make a tactical error, they both know about it," says David Luxton, Simunition's president. "Men who think they're invincible move more deliberately once they've felt the sting. I guess you could call the cartridges a 'tactical incentive device.'"

On the field, the paint doesn't lie. The Wolf Creek men are splattered with red as Rock Hill engages them before they reach cover. Wolf Creek bites the dust — no disgrace considering that Colorado's DOE Rocky Flats team will fight its way through the course seven times before it's finally declared winner of the event.

"I'm going to have nightmares about those guys coming after me," says Wolf Creek's Greg Siebuhr, remembering Rock Hill's aggressiveness.

"This one's over," concludes his team member Barry Autrey, taking off his body armor and stuffing a wad of chew into his mouth. "Let's get on to the next."

The scenario seems like a tactical

SWAT EXHIBITORS

More than 20 exhibitors demonstrated their equipment at the IPS/PMA National Championship of SWAT.

Simunition Technology of Ottawa, Ontario, Canada, supplied its new FM™ marking cartridges. According to David Luxton, Simunition president, the .38, 9mm and 5.56mm cartridges replace paint guns, cotton balls, or laser systems for training.

"We wanted to make a marking cartridge that would work in the men's personal sidearms," he said. "It was a feat — physics-wise."

The cartridges are fluorescent soap in a thin thermal plastic shell that will not freeze or melt. Consensus of the players was that the cartridge simulated real fire more closely than any other training gear. Rounds travel at 400 fps plus or minus 20%, and are powered by a primer cap with less than 1/2-grain of powder. Officially, their range is listed at 40 feet, but during the team vs. team event, shooters were making good shots at 60 to 75 feet.

"Its sound is realistic, and it's more realistic than laser gear," said Ruben Hernandez, Hanford, Washington, a champion pistol shooter.

Simunition soon will offer an inexpensive training barrel that will fit into a

standard weapon to fire the marking cartridges, but not accept live rounds.

"This will offer a safety factor never before possible," said Luxton.

The 9mm and 5.56mm cartridges will be available in late 1990. Cost for the .38 is \$250/1,000 and for the others, \$300/1,000.

According to Luxton, the marking cartridges have been used by special forces in North America and Europe. Police agencies have suggested a less powerful round, which Simunition has vetoed.

"Our market doesn't want a wimpy round," Luxton concluded. "It's for people who want to train seriously."

Glock rep Jim McNally discovered a lot of interest in his 9mm Model 17 and 19 pistols and his 10mm Model 20.

SigArms rep Barry Peterson showed a new laser scope, which premiered just

10 days prior to this event. The tiny scope has 5mW of power, the maximum for over-the-counter sales. Just 3.5 inches long, it retails for \$395.

Jim Hamilton of Martin Electronics demonstrated his SWAT-T and SWAT-TX flash-bangs. The T model stays in one piece and cannot be accidentally fired with a handgun.

— M.T.



SWAT-TX tactical distractor produces 185 decibels of sound at 5 feet.

nightmare, but teamwork produces success, according to the IPS staff, which trains law enforcement, military, and private security with government contracts in high-risk management. Teamwork and basics such as keeping your limbs in close and moving only under cover of protective fire.

"The best tactics are those that work. Tactics are more an art than a science," explains Brundson. "I'd like to see more teamwork. Usually people don't work as a team until half their men are dead or wounded."

On the sidelines, observers compare the scenario of the team vs. team on the field to real-life situations. In reality, they say, the white hats would outnumber the bad guys four to one to demoralize them. Law enforcement would use support equipment such as shields, smoke, fully automatic weapons, pyrotechnics, and thermal imaging to greatly enhance their tactical options. And under fire, they'd be more cautious, knowing that a hit would produce more than the sting of humiliation.

"They'd never be so bold in a real firefight," scoffs one observer.

But Brundson disagrees.

"I believe in my heart that once a commitment was made by the administrative authority, these men would



be as aggressive as they are here," he says. "For reason of ego, professional training, and identity. A person is what day to day he trains to be."

Six Miles High

Rappelling is a skill some SWAT teams say they rarely use on the job.

"We practice rappelling five times a year whether we need it or not," says

one man.

"Hell, we don't have any buildings over three stories high," adds another.

By luck of the draw, the Hillsborough team from Tampa, Florida, champions of the 1989 SWAT competition, is one of the first teams to rappel. According to the rules, one man rappels down the elevator shaft of the six-story tower, clearing certain floors as he goes, while two two-man teams go down the window and balcony sides to clear the others. The Hillsborough deputy sheriffs load their .38 revolvers with marking cartridges and tie them to lanyards before they put on their belts, harnesses, and web gear. While the event calls for standard rappelling, Hillsborough prefers Australian, "to get our guns and eyeballs — not our butts and heels — to the threat first," says team leader Ray Lawton.

More than 100 competitors watch Hillsborough rappel, hoping to improve their own teams' performance by collecting information about the targets and conditions inside the tower. Then, in 104 seconds, it's all over.

"What's your time? the watchers demand.

"We're the fast gun that everyone wants to beat," sighs Lawton.

Hillsborough tells its time — that number will be posted anyway. What it doesn't tell — what it feels every team should have the privilege of discovering for itself — is the presence of a trick target: a bad guy wearing body armor. In the darkened interior of the tower, in their speed and under stress, they shoot the target twice in the chest, as is their drill, instead of

Rappelling teams clear bottom after coming down central elevator shaft. Targets must be shot before feet hit the ground so some participants must swing around on the rope to score a hit.

in the head where it would do some good. But after a few more teams rappel, the word spreads and everyone knows about the trick



target. Hillsborough's Jimmy Moffitt shrugs.

"We view this as a training experience," he says. "The deciding factor in these events can be half a second. If you're not letter perfect, you fall behind."

Hillsborough's team is a part-time Emergency Response Team (ERT) that responds to drug busts and special situations. Geoff Fox, one of the team's snipers, is a junior high school resource officer. Moffitt works street crime. Lawton is in internal affairs.

"But when we put on our green uniforms and do a bust, people call us the 'green army' or 'Ninja mutant turtles,'" says Hillsborough's Mario Martinez.

Throughout the morning, each competing team learns the lessons of the six-story tower. The ropes are fast and burn their fingers. The stress addles their judgement. The balconies confound their footing. Dropped weapons and failure to engage a target add 30-second fault penalties to their time. Then, the event is over; the scores are tallied.

"You don't get no second chance. No alibis," Moffitt concludes. "You bring what you got and you run it till it breaks."

Behind Door Four

The simultaneous weapons takedown presents the most complicated and physically stressing scenario of the competition. The teams must run an obstacle course in gas masks, then execute four separate house-clearings, signaling after each for their sniper to fire.

"It should show our fitness," says Ralph Marshall, whose Hanford team is at the SWAT competition for the first time this year.

The Hanford men have the advantage of MCPU2 masks that give more visibility and air. Teams with old-style masks gulp for oxygen in the thick Joe-ja air like drowning fish. DOE teams that work for private corporations with big budgets can usually afford better equipment and training facilities than can police department teams. Shooting and physical fitness training are done on the job instead of after hours. At home Hanford men practice on a 700-meter obstacle course and have to run a seven-

Homestead, Florida, team members race through obstacle course wearing gas masks.

minute mile to qualify for the team. According to IPS staff, DOE teams tend to be younger, more physically fit, and well trained, while law enforcement teams have more experience using weapons in actual situations. DOE teams learn in an ivory rappelling tower, so to speak.

"I think people underestimate us," says Marshall. "We have a lot of ex-law enforcement and ex-military."

Suited up in their black jumpsuits, the Hanford men wipe sweat from their faces before they pull on their gas masks. They even use live ammo, and check their Beretta 92Fs. At the start signal, the men tumble over an 8-foot-high barrier. Then while the sniper trots off with his Remington 700 BDL to his position on a



roof, the others jump hurdles and belly crawl the course in their masks. As the rules dictate, the whole team must gather at one point before the men move on to the house-clearing.

"A team is only as good as the weakest man," murmurs one observer.

At the house clearing, they're winded but ready to go. At their signal, the sniper shoots over their heads, and then the men charge the first door. They execute a cross-over and a button hook as is their

drill, and fire two shots to the chest and one to the head of the bad guys. They signal "all-clear," and the sniper shoots again before they move to the second, the third, and fourth room.

Earlier, the team formulated its strategy, in a "participatory, not authoritarian, style of leadership until the plan fits everyone's needs," according to Hanford's Ken LaPierre.

"It's basic soldiering," concludes LaPierre. "You assess the situation and your mission objective, decide how to execute it, plan contingencies, and then use communication and service and support. Once you have a plan, you quit hammering on it. You just leave people alone to visualize it."

But the rules for the takedown are designed to stress the players. The men have to switch their weapons to their left hand between rooms, a movement that feels unnatural. And always, the clock ticks on, pushing them to their limits. In one room, they shoot after signaling all-clear to the sniper. In another room, Bruce Bosman counts coup when he shoots a hidden, trick target that almost no other teams see. After the event, they debrief. In those few heady moments while the adrenaline is still pumping, they can't remember exactly who shot what.

"Your training just takes over," concludes Bosman, "which is why it had better be good."

Fire Under Cover

In the cover and concealment event, Hillsborough draws first. In this event three shooters must fire 19 shots from behind cover while a shotgun man follows, and their sniper shoots five times at intervals.

"Hostage" bound by tape and handcuffs is watched by an opposing team member.

And always the clock ticks and other teams calculate how to beat their time. As the Hillsborough men pull on their knee and elbow pads, their banter is light to mask their tension. The early morning air is still cool, the sun is barely topping the trees at the IPS range.

"The sun is going to be right in my scope," complains Geoff Fox, the team's

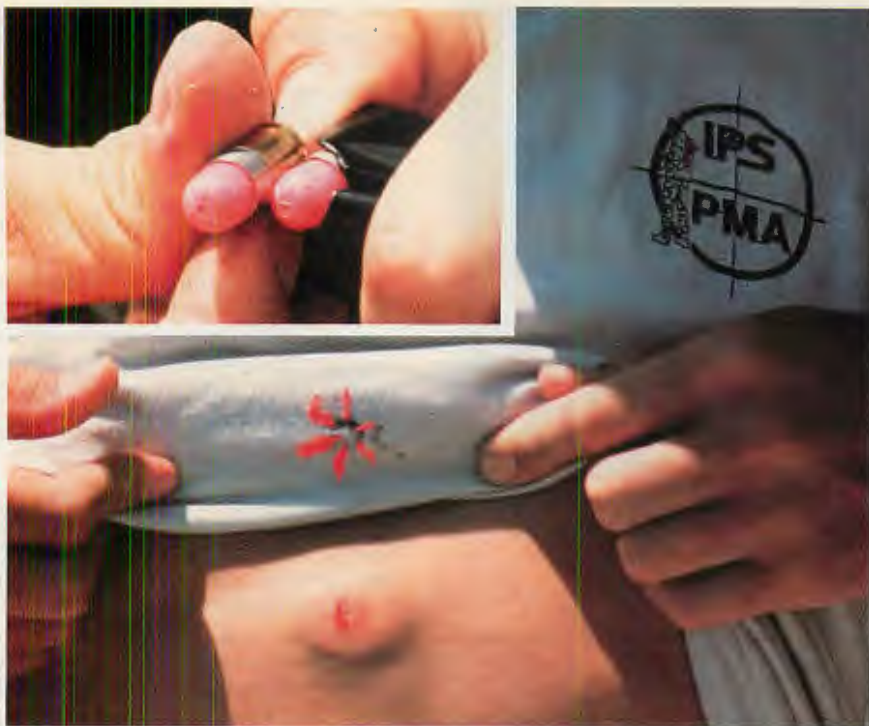

LEFT: Simunition 9mm marking rounds (above) produce a starburst of red on clothing and real-life welts on the human body (center).

BELOW: Two "dead" team members (one with head shot) are out of competition.



sniper for this event.

Ray Lawton looks up in alarm.

"Ha," Fox gloats with a laugh. "I got him going now."

"Don't fool with him now," Mario Martinez cautions.

"You know what we call Mario?" Fox asks me. "The elf from hell."

"I probably know more about these guys than I do about my wife," Jimmy Moffitt interjects.

On the range, Lawton, Martinez, and John Kirk race from a wall to a window to a barrel, firing at the targets in the recesses of fake rooms. Moffitt follows with the shotgun. On the roof, Fox drills the small white metal target so accurately that it breaks in half and falls off its stand. But in the shadows, they fail to shoot one target that appears to be a hostage but that is, in fact, a bad guy.

"You were right not to shoot it," Fox consoles later. "When in doubt, don't."

But in a competition, good judgement doesn't always make for points.

Countersniper

Atop the rappelling tower, each team's countersniper takes his position in turn, trying to catch his breath from the six-story climb, done in two minutes. When the IPS official gives them the go-ahead to fire, they'll have to pick off three unfriendlies — sparing a hostage — as the targets move into the windows and door of a house 165 yards in the distance. Afterwards, their co-sniper will fire an M16, Ruger Mini 14 or AR-15 at another target.



LEFT: Shotgun man follows team members who fire from behind cover. This is member of Indiana Law Enforcement ERT of Muncie, Indiana, which took first place in this event.

ABOVE: Participants in cover and concealment event race through various stages and ultimately fire 19 shots from behind cover.



In this, the last event of the competition, the teams walk their snipers to the tower. Then, because sniping is a solitary discipline, the sniper executes his skill alone as the others stay below to watch the progress on video or count the number of shots fired. Some teams hear only one shot as the snipers disqualify themselves by firing before the official green light. Others hear six, seven, or eight shots as the snipers and co-snipers try to hit the targets. But when the snipers come down from the tower, their faces tell the story: the smiles or the tight-lipped frowns as they stalk off with their rifles.

"This event should be earlier in the competition," observes one competitor. "It puts too much pressure on one man."

Winners All

Throughout the events, the participants

Savannah River DOE clears obstacles in simultaneous weapons takedown event.



At exhibition area combatant fires Precision Arms suppressed rifle.

make suggestions for changing the IPS/PMA competition: that teams should be prevented from viewing the targets and tactics of each event until it's their turn, that they should be disqualified the instant they shoot a hostage or miss a bad guy. But they agree that the competition is unique in that it creates events that marry tactical response to physical fitness.

"In some competitions, you can bully your way through," says one participant. "Not here."

In effect, the men compete less against the other teams than against their own weaknesses. They plan strategies, but the execution depends on their team's skill and composure. The pressure of the timed events tests their nerves and teamwork. If they learn something from the competition, they win, whether or not they score high.

AND THE WINNERS ARE ...

Teams competing in the second National Championship of SWAT were so evenly matched that only a 16-point spread separated the top six teams. Rock Hill SWAT from Rock Hill, South Carolina, won the competition with 52 points out of a possible 100.

"Winners and losers were decided by 1/100ths and 1/1000ths of a point," said IPS official Eddie Hulsey.

"Competition was tougher, events were harder," agreed Buddy Devinney of Rock Hill. "For example, last year the sniper targets were stationary. This year, they moved."

"The marking cartridges made the team vs. team much more competitive," added Harold Duke, also of Rock Hill.

Hulsey predicted that more teams will enter in 1991. This year, U.S. Army Rangers from Camp Frank D. Merrill helped officiate as the number of competing teams nearly doubled.

"Competition is stiff, and its going to get stiffer," Husley said.

Final Standings:

1. Rock Hill PD, South Carolina 52 points
2. DOE Hanford, Washington 50
3. Hillsborough County Sheriff Office, Florida 42
4. Gwinnett County PD, Georgia 40
5. DOE Las Vegas, Nevada 38
6. DOE Pantex, Texas 36
7. Indiana Law Enforcement, Indiana 30
8. Champaign PD, Illinois 24

Winners of Events:

Brigade Quartermaster Tactical Rappel: Rock Hill PD, South Carolina.

Sturm, Ruger Team Cover and Concealment: Indiana Law Enforcement, Indiana.

Pointblank Simultaneous Takedown: DOE Pantex, Texas.

Simunition Team vs. Team: DOE Rocky Flats, Colorado.

Federal Countersniper: Hall County Sheriff Office, Georgia.

And that's the point.

"You deal with stress all the time on the job," says Jimmy Moffitt. "But here, even though you're not going to get shot and die, in the stress of being timed, you see the deficiencies in your training and shooting."

As one competitor observes, "It's better mistakes happen here than in real life." ❌



WHO DARES WINS

American Intel Officer Masterminds Coup in Ecuador

by C.R. McQuiston

THE handsome, 6-foot-2, popular Ecuadorian senator was elected president of his country on 8 November 1961. The population and the press were enamored of Carlos Julio Arosemena because he was always in some affair that lent flavor to gossip. He came to office with strong backing from the air force and when he assumed office he was recognized by the military high command. Over the next two years, however, this support eroded, turned to distrust, then to rancor due to his personal and political conduct.

Arosemena was a formidable boozier who loved to chase the ladies (especially if they were other men's wives), and one who could commit the most outrageous acts while under the influence — which was often. He fancied himself to be a singularly macho man and would, on the slightest whim, pull out a hidden revolver and start



blazing away.

The two most bizarre pistolero escapades occurred on 31 March 1963 and later the following April. In the first incident, Arosemena and his cronies arrived at the *Cuatro y Media* restaurant and began harassing the gay waiters. El Presidente forced one of the waiters to put a lamp shade on his head for Arosemena to shoot off. Instead, the drunken sot hit the waiter in the head. He then arranged to have his personal secretary Galo Ledesma take the blame. In the second incident, during a drunken brawl at *Le Toucan*, a fashionable restaurant on the outskirts of Quito, the

(L to R) Lieutenant Mishler and Sergeant Torres-Robles of the MTT with Captain Uscatagui in Quito, 1963. Photo: courtesy author

chief executive climbed atop one of the banquet tables, pulled his revolver, and forced some of the social lions to remain seated while he fired several shots over their heads as he freely urinated over them. If for no other reason, this fiasco surely placed his name on the top of the U.S. Army Counterintelligence Detachment's black list.

These flamboyant spectacles were characteristic of Arosemena's conduct at the

height of his power in 1963. Oddly enough, his behavior and the fact that he was known to be a communist sympathizer, following a path that would lead Ecuador into the Marxist camp, seemed to go unnoticed for a long time — until 11 July 1963, when he suddenly found himself flying to exile in Panama.

The stable, right-wing elements of Ecuador were principally in the military, as is traditional in South America, but they had deferred corrective action for too long and thus lost their opportunity to stand up to Arosemena's growing power. Because they were unorganized they feared Arosemena — who was organized — and had been consolidating his power. The military leaders who had earlier supported him now clearly recognized his threat to their own, and the national, well-being. They chafed at the daily new affronts to Ecuadorian dignity, such as when Chilean President Allendire made a state visit just before Christmas 1962 and the dead-drunk Arosemena vomited on him at the welcoming banquet. But, although they had lost all respect for their president, Ecuadorian military leaders had to remain silent for fear of *disponibilidad*, the death-by-limbo he could call down on anyone. In addition, it was clear from the open and alarming innuendoes in the Havana press and radio about possible Cuban intervention that Arosemena was a favorite of Castro. Further, as president, he was in control of the nation's economic development, and thus in a position to do irreparable harm if provoked.

Disenchantment Grows

There were no less than a dozen plots from November 1961 through July 1963 to depose Arosemena, but they lacked leadership and effective coordination. The strongest of these plots came from within the military forces, where there was enough camaraderie and just plain guts to potentially muster into some plan of action.

Although Arosemena maintained his liaison with Castro, the economic support of the United States was still continuing, but with much less enthusiasm than before. The United States was not enamored with the drunken behavior of Arosemena or his obvious flirtation with communism. Arosemena was constantly criticized for refusing to fire extreme leftists in the government. Ecuador's military leaders demanded that Arosemena break all relations with Cuba, and he outwardly agreed to do so, but in May 1962 he struck back by firing the anti-communist minister of defense, and the commanding officers of the air force and army.

Equally alarming were incidents in April 1962, when there were many arrests of Ecuadorian nationals returning to Ecuador from three-month courses in guerrilla training in Cuba, as these individuals were being schooled in Cuba to train revolutionary cadres all over Ecuador. In August 1962 the National Democratic



Front and the conservatives forced Arosemena to dismiss his leftist governor of Guayas Province as the initial move of a promised campaign to eliminate the extreme leftists in the government.

The long-awaited catalyst to change this unwholesome situation came in the person of a U.S. Army major newly assigned as an intelligence adviser to the Ecuadorian army. Major Edward Breslin was a redheaded, hot-tempered Irishman who found that it was difficult, if not impossible, to keep himself in check in the face of the almost comic business-as-usual posture maintained by not only the Army, but our intelligence community and the ostentatious U.S. State Department personnel as well.

The State Department, functioning through our embassy in Quito, was watching and waiting for something to happen. In the meantime, they were reinforcing doors and windows and "studying plans" to improve their security against the rock-throwing mobs that had appeared the past year. The past had shown them that they could not expect any help from the local police against the demonstrators, who before had literally held them prisoners within the embassy.

The State Department believed that the CIA was initiating actions against radical elements, but the truth is the CIA was occupying their time with binocular surveillances, and organizing reports from paid informants on the structures and capabilities of all the radical elements. They were such good paper organizers that

they even received "congratulations from headquarters," and had a "champagne victory celebration in the station," on 2 April 1963. Ironically, this information comes from the diary of turncoat Philip Agee, a former deep-cover agent of the CIA, and this particular entry occurred at the precise moment that the *Curso de Estudios Especiales* was in progress at the military academy in Quito. They had no idea that Ed Breslin was carrying out a positive covert action against Arosemena and the leftists in Ecuador. They listed Major Breslin as one of their valuable contacts, but did not have the foggiest idea at this point that his operations would topple the regime they sought to "understand."

Every American official who could see the ridiculousness of a situation where Arosemena was being allowed unopposed to lead Ecuador into corruption and communism was forced to hold his tongue because the State Department, the executive branch and many in the legislature were disposed to support the Arosemena regime and did not want to hear any opposition. An American officer could easily be relieved of duty and sent home in disgrace for voicing objections, so they just kept in mind that they would be reassigned in three years if they kept their mouth shut, and concentrated on having the host country love them.

Time for Action

Breslin, a tank commander under Patton, an adviser and instructor of the tank crews for the Bay of Pigs invasion, and a Special

Agent (CIC) of Japan-Korea operations, guardedly watched his fuse burn shorter and shorter to the point of explosion until he could stand no more. He finally initiated a one-man campaign to counter the lethargic apathy that had settled on the scene around him. Certain of the eventual disaster to befall Ecuador under President Arosemena, Breslin worked up a plan to depose this despot by developing a meaningful intelligence capability that would utilize the existing resources of the host country.

Exercising his considerable knowledge of how to channel DoD funds to implement his plan, Breslin began by requesting a Mobile Training Team (MTT) from the School of the Americas at Fort Gulick in the Panama Canal Zone.

The School of the Americas had recently become a major diplomatic tool when President John F. Kennedy brought this Army operation into the spotlight as a major U.S. effort to win the hearts and minds of all Latin countries with our government's love and genuine concern. Within the school was an outstanding Military Intelligence Committee teaching intelligence, counterintelligence and counterinsurgency operations to 23 Latin-American countries. Breslin was determined to establish a training program that would result in the creation of the first counterintelligence unit in the history of the Ecuadorian army — an effective tool in proper hands.

Lieutenant Colonel William DeSalvo was commanding officer of the MI Committee, and a telephone call to him arranged for an MTT to deploy to Ecuador and train the desired unit. Heading this team to Ecuador was yours truly, then-Captain, C.R. McQuiston. It was my ninth year in the Counterintelligence Corps of the U.S. Army, and an assignment as Associate Professor of Military Science and Tactics at Fort Gulick was my fifth major assignment in intelligence duties. The official language at Gulick was Spanish, and all instruction was presented in that language.

When we were ordered to go to Ecuador and teach the standard military intelligence course, we did not know that Breslin intended to overthrow the Arosemena regime. When I arrived on station and conferred with Breslin, he requested that several non-standard courses such as surreptitious methods of entry, special electronics warfare, counterterrorism and psychological warfare be added to the curriculum. I began to suspect that we were going to be doing a lot more than just enhancing Ecuador's ability to resist radical exploitation. After we had been on station for several weeks it became quite clear that we were on the front lines against Arosemena.

Breslin invited me to his house for dinner one night and after the meal he began to relate to me his overall rationale for the defeat of Arosemena. "I do not like drunks. I do not like woman chasers, and I

~~CONFIDENTIAL~~

MILITARY INTELLIGENCE MOBILE TRAINING TEAM #1
Colegio Militar, Eloy Alfaro
Quito, Ecuador

27 May 1963

SUBJECT: Final Report, Military Intelligence Mobile Training Team to Ecuador (94-MTF-109-63) (RIS OSQPO 125).

THRU: Chief
US Army Mission to Ecuador
c/o US Embassy
Quito, Ecuador

Commander
US Military Group, Ecuador
c/o US Embassy
Quito, Ecuador

TO: Commanding General
US Army Caribbean
AFPM: OMA
Fort Amador, Canal

SUBJECT: Final Report, Military Intelligence Mobile Training Team to Ecuador (94-MTF-109-63) (RIS OSQPO 125).

1. (U) The number of indigenous personnel trained. Four (4) officers and four sergeants (2) enlisted men.

2. (U) Mission to teach a basic etc. (6) week course in counterintelligence to the above personnel.

3. (U) Schools, courses or training installations utilized. The international staff, class and training facilities of the Colegio Militar, Eloy Alfaro, Quito, Ecuador, were utilized during the course.

4. (U) Adequacy of existing intelligence and intelligence support to mission of the Mobile Training Team.

5. (U) Type, quantity, condition and state of maintenance of material on which training was conducted. Not applicable.

6. (U) Summary of existing conditions. No mission of the MTT to be conducted. The first intelligence course at part of the MTT's mission was to be conducted in the form of a seminar. The MTT's mission was to be conducted in the form of a seminar. The MTT's mission was to be conducted in the form of a seminar.

7. (U) Evaluation of the effectiveness of training. The training program presented by the MTT was highly effective. The MTT's mission was to be conducted in the form of a seminar. The MTT's mission was to be conducted in the form of a seminar.

8. (U) Recommendations for future training. The MTT's mission was to be conducted in the form of a seminar. The MTT's mission was to be conducted in the form of a seminar.

9. (U) Other information. The MTT's mission was to be conducted in the form of a seminar. The MTT's mission was to be conducted in the form of a seminar.

10. (U) Other information. The MTT's mission was to be conducted in the form of a seminar. The MTT's mission was to be conducted in the form of a seminar.

11. (U) Other information. The MTT's mission was to be conducted in the form of a seminar. The MTT's mission was to be conducted in the form of a seminar.

12. (U) Other information. The MTT's mission was to be conducted in the form of a seminar. The MTT's mission was to be conducted in the form of a seminar.

13. (U) Other information. The MTT's mission was to be conducted in the form of a seminar. The MTT's mission was to be conducted in the form of a seminar.

14. (U) Other information. The MTT's mission was to be conducted in the form of a seminar. The MTT's mission was to be conducted in the form of a seminar.

15. (U) Other information. The MTT's mission was to be conducted in the form of a seminar. The MTT's mission was to be conducted in the form of a seminar.

16. (U) Other information. The MTT's mission was to be conducted in the form of a seminar. The MTT's mission was to be conducted in the form of a seminar.

17. (U) Other information. The MTT's mission was to be conducted in the form of a seminar. The MTT's mission was to be conducted in the form of a seminar.

18. (U) Other information. The MTT's mission was to be conducted in the form of a seminar. The MTT's mission was to be conducted in the form of a seminar.

19. (U) Other information. The MTT's mission was to be conducted in the form of a seminar. The MTT's mission was to be conducted in the form of a seminar.

20. (U) Other information. The MTT's mission was to be conducted in the form of a seminar. The MTT's mission was to be conducted in the form of a seminar.

21. (U) Other information. The MTT's mission was to be conducted in the form of a seminar. The MTT's mission was to be conducted in the form of a seminar.

22. (U) Other information. The MTT's mission was to be conducted in the form of a seminar. The MTT's mission was to be conducted in the form of a seminar.

23. (U) Other information. The MTT's mission was to be conducted in the form of a seminar. The MTT's mission was to be conducted in the form of a seminar.

24. (U) Other information. The MTT's mission was to be conducted in the form of a seminar. The MTT's mission was to be conducted in the form of a seminar.

25. (U) Other information. The MTT's mission was to be conducted in the form of a seminar. The MTT's mission was to be conducted in the form of a seminar.

26. (U) Other information. The MTT's mission was to be conducted in the form of a seminar. The MTT's mission was to be conducted in the form of a seminar.

27. (U) Other information. The MTT's mission was to be conducted in the form of a seminar. The MTT's mission was to be conducted in the form of a seminar.

28. (U) Other information. The MTT's mission was to be conducted in the form of a seminar. The MTT's mission was to be conducted in the form of a seminar.

29. (U) Other information. The MTT's mission was to be conducted in the form of a seminar. The MTT's mission was to be conducted in the form of a seminar.

30. (U) Other information. The MTT's mission was to be conducted in the form of a seminar. The MTT's mission was to be conducted in the form of a seminar.

31. (U) Other information. The MTT's mission was to be conducted in the form of a seminar. The MTT's mission was to be conducted in the form of a seminar.

32. (U) Other information. The MTT's mission was to be conducted in the form of a seminar. The MTT's mission was to be conducted in the form of a seminar.

33. (U) Other information. The MTT's mission was to be conducted in the form of a seminar. The MTT's mission was to be conducted in the form of a seminar.

34. (U) Other information. The MTT's mission was to be conducted in the form of a seminar. The MTT's mission was to be conducted in the form of a seminar.

35. (U) Other information. The MTT's mission was to be conducted in the form of a seminar. The MTT's mission was to be conducted in the form of a seminar.

36. (U) Other information. The MTT's mission was to be conducted in the form of a seminar. The MTT's mission was to be conducted in the form of a seminar.

37. (U) Other information. The MTT's mission was to be conducted in the form of a seminar. The MTT's mission was to be conducted in the form of a seminar.

38. (U) Other information. The MTT's mission was to be conducted in the form of a seminar. The MTT's mission was to be conducted in the form of a seminar.

39. (U) Other information. The MTT's mission was to be conducted in the form of a seminar. The MTT's mission was to be conducted in the form of a seminar.

40. (U) Other information. The MTT's mission was to be conducted in the form of a seminar. The MTT's mission was to be conducted in the form of a seminar.

41. (U) Other information. The MTT's mission was to be conducted in the form of a seminar. The MTT's mission was to be conducted in the form of a seminar.

42. (U) Other information. The MTT's mission was to be conducted in the form of a seminar. The MTT's mission was to be conducted in the form of a seminar.

43. (U) Other information. The MTT's mission was to be conducted in the form of a seminar. The MTT's mission was to be conducted in the form of a seminar.

44. (U) Other information. The MTT's mission was to be conducted in the form of a seminar. The MTT's mission was to be conducted in the form of a seminar.

45. (U) Other information. The MTT's mission was to be conducted in the form of a seminar. The MTT's mission was to be conducted in the form of a seminar.

46. (U) Other information. The MTT's mission was to be conducted in the form of a seminar. The MTT's mission was to be conducted in the form of a seminar.

47. (U) Other information. The MTT's mission was to be conducted in the form of a seminar. The MTT's mission was to be conducted in the form of a seminar.

48. (U) Other information. The MTT's mission was to be conducted in the form of a seminar. The MTT's mission was to be conducted in the form of a seminar.

49. (U) Other information. The MTT's mission was to be conducted in the form of a seminar. The MTT's mission was to be conducted in the form of a seminar.

50. (U) Other information. The MTT's mission was to be conducted in the form of a seminar. The MTT's mission was to be conducted in the form of a seminar.

51. (U) Other information. The MTT's mission was to be conducted in the form of a seminar. The MTT's mission was to be conducted in the form of a seminar.

52. (U) Other information. The MTT's mission was to be conducted in the form of a seminar. The MTT's mission was to be conducted in the form of a seminar.

53. (U) Other information. The MTT's mission was to be conducted in the form of a seminar. The MTT's mission was to be conducted in the form of a seminar.

54. (U) Other information. The MTT's mission was to be conducted in the form of a seminar. The MTT's mission was to be conducted in the form of a seminar.

55. (U) Other information. The MTT's mission was to be conducted in the form of a seminar. The MTT's mission was to be conducted in the form of a seminar.

56. (U) Other information. The MTT's mission was to be conducted in the form of a seminar. The MTT's mission was to be conducted in the form of a seminar.

57. (U) Other information. The MTT's mission was to be conducted in the form of a seminar. The MTT's mission was to be conducted in the form of a seminar.

58. (U) Other information. The MTT's mission was to be conducted in the form of a seminar. The MTT's mission was to be conducted in the form of a seminar.

59. (U) Other information. The MTT's mission was to be conducted in the form of a seminar. The MTT's mission was to be conducted in the form of a seminar.

60. (U) Other information. The MTT's mission was to be conducted in the form of a seminar. The MTT's mission was to be conducted in the form of a seminar.

61. (U) Other information. The MTT's mission was to be conducted in the form of a seminar. The MTT's mission was to be conducted in the form of a seminar.

62. (U) Other information. The MTT's mission was to be conducted in the form of a seminar. The MTT's mission was to be conducted in the form of a seminar.

63. (U) Other information. The MTT's mission was to be conducted in the form of a seminar. The MTT's mission was to be conducted in the form of a seminar.

64. (U) Other information. The MTT's mission was to be conducted in the form of a seminar. The MTT's mission was to be conducted in the form of a seminar.

65. (U) Other information. The MTT's mission was to be conducted in the form of a seminar. The MTT's mission was to be conducted in the form of a seminar.

66. (U) Other information. The MTT's mission was to be conducted in the form of a seminar. The MTT's mission was to be conducted in the form of a seminar.

67. (U) Other information. The MTT's mission was to be conducted in the form of a seminar. The MTT's mission was to be conducted in the form of a seminar.

68. (U) Other information. The MTT's mission was to be conducted in the form of a seminar. The MTT's mission was to be conducted in the form of a seminar.

69. (U) Other information. The MTT's mission was to be conducted in the form of a seminar. The MTT's mission was to be conducted in the form of a seminar.

70. (U) Other information. The MTT's mission was to be conducted in the form of a seminar. The MTT's mission was to be conducted in the form of a seminar.

71. (U) Other information. The MTT's mission was to be conducted in the form of a seminar. The MTT's mission was to be conducted in the form of a seminar.

72. (U) Other information. The MTT's mission was to be conducted in the form of a seminar. The MTT's mission was to be conducted in the form of a seminar.

73. (U) Other information. The MTT's mission was to be conducted in the form of a seminar. The MTT's mission was to be conducted in the form of a seminar.

74. (U) Other information. The MTT's mission was to be conducted in the form of a seminar. The MTT's mission was to be conducted in the form of a seminar.

75. (U) Other information. The MTT's mission was to be conducted in the form of a seminar. The MTT's mission was to be conducted in the form of a seminar.

76. (U) Other information. The MTT's mission was to be conducted in the form of a seminar. The MTT's mission was to be conducted in the form of a seminar.

77. (U) Other information. The MTT's mission was to be conducted in the form of a seminar. The MTT's mission was to be conducted in the form of a seminar.

78. (U) Other information. The MTT's mission was to be conducted in the form of a seminar. The MTT's mission was to be conducted in the form of a seminar.

79. (U) Other information. The MTT's mission was to be conducted in the form of a seminar. The MTT's mission was to be conducted in the form of a seminar.

80. (U) Other information. The MTT's mission was to be conducted in the form of a seminar. The MTT's mission was to be conducted in the form of a seminar.

81. (U) Other information. The MTT's mission was to be conducted in the form of a seminar. The MTT's mission was to be conducted in the form of a seminar.

82. (U) Other information. The MTT's mission was to be conducted in the form of a seminar. The MTT's mission was to be conducted in the form of a seminar.

83. (U) Other information. The MTT's mission was to be conducted in the form of a seminar. The MTT's mission was to be conducted in the form of a seminar.

84. (U) Other information. The MTT's mission was to be conducted in the form of a seminar. The MTT's mission was to be conducted in the form of a seminar.

85. (U) Other information. The MTT's mission was to be conducted in the form of a seminar. The MTT's mission was to be conducted in the form of a seminar.

86. (U) Other information. The MTT's mission was to be conducted in the form of a seminar. The MTT's mission was to be conducted in the form of a seminar.

87. (U) Other information. The MTT's mission was to be conducted in the form of a seminar. The MTT's mission was to be conducted in the form of a seminar.

88. (U) Other information. The MTT's mission was to be conducted in the form of a seminar. The MTT's mission was to be conducted in the form of a seminar.

89. (U) Other information. The MTT's mission was to be conducted in the form of a seminar. The MTT's mission was to be conducted in the form of a seminar.

90. (U) Other information. The MTT's mission was to be conducted in the form of a seminar. The MTT's mission was to be conducted in the form of a seminar.

91. (U) Other information. The MTT's mission was to be conducted in the form of a seminar. The MTT's mission was to be conducted in the form of a seminar.

92. (U) Other information. The MTT's mission was to be conducted in the form of a seminar. The MTT's mission was to be conducted in the form of a seminar.

93. (U) Other information. The MTT's mission was to be conducted in the form of a seminar. The MTT's mission was to be conducted in the form of a seminar.

94. (U) Other information. The MTT's mission was to be conducted in the form of a seminar. The MTT's mission was to be conducted in the form of a seminar.

95. (U) Other information. The MTT's mission was to be conducted in the form of a seminar. The MTT's mission was to be conducted in the form of a seminar.

96. (U) Other information. The MTT's mission was to be conducted in the form of a seminar. The MTT's mission was to be conducted in the form of a seminar.

97. (U) Other information. The MTT's mission was to be conducted in the form of a seminar. The MTT's mission was to be conducted in the form of a seminar.

98. (U) Other information. The MTT's mission was to be conducted in the form of a seminar. The MTT's mission was to be conducted in the form of a seminar.

99. (U) Other information. The MTT's mission was to be conducted in the form of a seminar. The MTT's mission was to be conducted in the form of a seminar.

100. (U) Other information. The MTT's mission was to be conducted in the form of a seminar. The MTT's mission was to be conducted in the form of a seminar.

Confidential final report filed with MTT HQ barely hinted at Major Ed Breslin's plan to topple Arosemena's government. Documents courtesy author.

do not like communists. No one else seems capable of having the balls to do anything about it, so I am going to do the job." I asked him if he was afraid that the thing could backfire and he said "Not in the slightest!" At the time no one else in our government knew the full impact of these developing plans.

The other members of the MTT were Lieutenant Edward Mischler, and Sergeant First Class Edgardo Torres-Robles, all experienced CIC agents and instructors. These men collected the necessary lesson plans and training aids such as slides, audio tapes, movies and similar materials that were kept on standby at the MI Committee for just such a requirement. The necessary Basic Program of Instruction for training Basic Counterintelligence Agents included: Surveillance, Report Writing, Utilization of Sound Equipment, Surreptitious Entry,

Investigative Photography, Principles of Communism, Principles of Democracy, Counterintelligence Operations, Counterinsurgency Operations, Physical Defense, Establishing Informant Nets, Vetting Informants.

The inventory was augmented, as required, for special instruction classes and the team was dispatched to Quito, Ecuador, to accomplish its objective.

Training an Action Cadre

Major Ed Breslin met the MTT and then spent the next two days familiarizing the team with their surroundings. They were given the entire third floor of the *Academia Eloy Alfaro*, the West Point of Ecuador, to accomplish their training. The team members were housed at the Hotel Savoy in Quito and all necessary transportation and supplies were laid on. This operation was named *Curso De Estudios Especiales*, and

was held in the utmost secrecy.

The MTT graduated the class in Estudios Especiales on 27 May 1963 and returned to Panama on 29 May 1963. One month later, to the day, the new CIC Group in Ecuador took control of the country, banished Arosemena and his henchmen to Panama, and dismantled the communist organization. Some 200 known terrorists were killed in two days of lightning war, communism in Ecuador was repulsed and the country was declared free of such elements for our lifetime. Today, some 27 years later, Ecuador is free, democratic, and economically viable.

But you won't actually find an official report that tells the complete true story, because the whole damned operation would never have happened if it had depended on the bureaucrats of the Army, CIA, the State Department, and the embassy in Quito. If it had not been conceived by Major Breslin, who seized the initiative and proceeded with his neck stuck out a country mile, no one would have ever taken the time and effort to secure the liberty of Ecuador and protect the best interests of the United States.

Breslin covertly channeled the necessary funds, and guided the new CIC agents through their first stumbling steps in a new profession by funding the new detachments and supervising exercises conceived by the MTT to sharpen the skills of the new agents. Breslin conducted covert operations at the Ministry of Defense after midnight. Desks and lockers of key personnel were entered and photocopies of certain revealing key documents were made and added to newly created personnel files maintained by the CI detachments.

Surveillance exercises were a major focus of the training of the CI agents. Breslin doggedly pursued the terrorists' activities, either countering them before they could be accomplished, or making certain that the net of paid informants, which the new CI team had established within the news media, clearly identified each move through their regular reports, which were carefully screened and acted upon.

Implementing the Plan

Newly established informant nets established by the CI team revealed that the communist terrorist teams, trained in Cuba and infiltrated back into Ecuador, had two major objectives in the course of their efforts to overthrow the legal government of Ecuador. Arosemena appointed and supported many leftists in the government and was working hand-in-glove with them to achieve a terrorist takeover that would install him as a Castro-style dictator.

The subversives' first objective was to assemble the necessary supplies to fabricate black powder and TNT bombs to terrorize the population. These caused very little physical damage but were designed to kill as many officials as possible. The terrorist bombings began on 16 January 1962 when two Curmca churches were bombed on the



President Arosemena (right) shakes hands with U.S. Secretary of Commerce Luther Hodges at opening of Chicago Trade Fair in July, 1962. Between them is Mayor Richard Daley. Disheveled Arosemena looks as though he took champagne flight from Quito. Photo: AP/Wide World

eve of the national convention of URJE (*Union Revolucionario De Joventude Ecuatoriano*, a leading left-wing terrorist group). No injuries were sustained on that occasion, but scores of bombings continued right up to 29 May 1963 when the CI detachment graduated. On that date, the courts were addressing the case of Guillermo Layedra, who had blown his hands off while training URJE terrorists to make bombs. In overview, the deaths and injuries from all this bombing were minimal — their impact was largely psychological.

URJE's bomb factory was set up in Quayaquil, and personnel were sent to that site to prepare the necessary explosives for use when the command was given. Breslin kept himself informed of the times and places a particular project would be implemented, and he deployed the first CIC detachment to Quayaquil under the command of Captain Federico Davila to surveil and discover, through undercover agents and informants, the precise plans of the terrorists. When this was accomplished, the Quayaquil CIC detachment formed their plans to raid the bomb factory and arrest all the personnel involved.

The second CIC detachment was deployed in Quito and targeted a terrorist operation that had been named by the terrorists as Operation Condor I. Several terrorists had escaped from prison by overpowering a guard, and when the guard was freed he told Captain Fernando Uscategui and his Quito personnel of the terrorist's plans he had overheard regarding the hijacking of a jet airliner loaded with passengers. The terrorists intended to seize the plane and force the pilots to take off and circle the capital where they would radio

their demands for the release of all their comrades held in prison. If their demands were not met, they would threaten to crash the airplane into the capitol building, killing all on board.

Even with the major objectives of the CIC teams demanding most of their resources, they did not neglect the necessary business of planning for several positive actions after the terrorists' plans had been thwarted. They had prepared the necessary list of communists and their supporters who had to be apprehended, and they delineated team assignments in depth as the operations order ran its projected course. Both Uscategui and Davila utilized the resources of the National Police to lead the actual assaults, and to guarantee that the identity of CI agents would be protected. The National Police directed a series of armed attacks against the main bomb factory in Quayaquil and several raids on provincial terrorist headquarters. The army established a total blockade of the country to isolate the terrorists and preclude the mobility they would need to accomplish their intended operations.

Gratifying Success

The terrorists were caught *flagrante delicto* by the National Police at the bomb factory in Quayaquil, and when their comrades attempted to seize a jetliner at the Quito airport, they suddenly found themselves completely surrounded by CI agents who appeared out of the fueling pits on the tarmac and from the aircraft itself. Four terrorists were captured with arms, bombs, tear gas, radios and TNT. The Ecuadorian army CIC group did a magnificent job on its first assignment and

Continued on page 123

"WHAT'S A WOMAN DOING HERE?"

"IT is 20 minutes to eight in the evening on a beach somewhere in Vietnam. The stars look close enough to touch. The sound of the surf is pretty reassuring and the sand underneath my poncho liner is warm and soft."

This was Dickey Chapelle reporting from Southeast Asia in the fall of 1965. She was speaking into a tape recorder in hushed tones so as not to draw enemy fire. The Viet Cong "know exactly where we are," she continued, however her deep voice betrayed little anxiety or emotion. It was, after all, just another day at the office for America's most famous female war correspondent.

At the time she made the recording, she was lying on a beach, surrounded by 70 U.S. Marines, who were trying to steal a few hours of fitful sleep. Unlike the young troops around her, most of whom had little combat experience, she was a veteran of more than a dozen shooting wars. Her combat experience stretched all the way back to another beach, two decades earlier, on Iwo Jima. She had been with the Marines then, too. It was their bloodiest single engagement dur-



Photo: Wide World Photos

7300 Days, 2 Wars, 4 Revolutions Finally Kill Dickey Chapelle

by Neil Livingstone and Barbara Newman

ing World War II.

Only days later, on 4 November 1965, she was dead. She died on the floor of a medevac helicopter in a pool of blood after her carotid artery was pierced by a grenade fragment near the village of Chu Lai. She had been on patrol with her beloved Marines, when the man walking in front of her stepped on a mine. At the time of her death, she was wearing the globe and anchor Marine insignia given to her by General Wallace M. Greene, Jr., the Marine Commandant.

Her love affair with the Marine Corps began on Iwo Jima and never ended. According to Bernie Yoh, a counterinsurgency expert who learned his trade fighting the Japanese in China in the 1930s and met Dickey in Vietnam in the early 1960s, "Her face and expression would change when she spoke of her Marines."

With her passing, America lost one of its most courageous war correspondents; a pioneer in the movement for women's equality, to which she would become an important symbol. As debate rages over women in combat and as plans go forward for the Vietnam Women's Memorial, it is well to

remember Dickey Chapelle. Not only was she the only female war correspondent to die in Vietnam, but long before women were routinely accepted as foreign correspondents — and almost never as war correspondents — Dickey's byline was known throughout the world.

She often referred to herself as a "dame" or a "broad" and was said to be able to "slap a man with her eyes." She was, in the words of one contemporary, "the girl who chases fire engines around the world." By the time of her death, she had come under hostile fire from the Hungarians, Vietnamese, Japanese, Communist Chinese, French, Cubans, Laotians, Algerians, Lebanese, Pakistanis, and Indians.

She was the first female journalist accredited to the Sixth Fleet and the only woman, up to the time of her death, authorized to jump with U.S. airborne forces. She didn't jump for the first time until she was 41 years old, but in the years that followed made 16 jumps, including five with the Special Forces in Vietnam into forward battle areas. She preferred to jump at night so she couldn't see the ground. Despite her belief that parachute jumping was simply "a way of getting to the ground," she could wax eloquent about a moonlit night jump at Fort Benning.

"She Didn't Seem Like a Girl"

Throughout her career, she always insisted on being treated no differently than the men she covered. She ate the same C-rations, spread her poncho in the same mud, and could keep up with the best troops. She smoked too much and swore like a drill sergeant in a husky Lauren Bacall voice. The best compliment she ever received, Dickey liked to say, was that made by a U.S. Marine: "She didn't seem like a girl."

Once, when she was on patrol with South Vietnamese commandos, she nearly stepped on a poisonous snake in the trail. One of the men grabbed the snake before it could strike and cut the head off. The soldier wasn't going to show her the snake, but she protested, and to demonstrate that she wasn't intimidated by the incident she wore the snake around her neck until it began to stink.

Fellow reporter, and now syndicated columnist, Georgie Ann Geyer met Dickey in the Dominican Republic during the 1965 U.S. intervention. "I decided that the safest way to dress was in a floral dress so that I looked like the women living there," she recalls. "I go to meet Dickey, however, and she's in Marine dress from cap to fatigues, right down to her boots."

No one ever described Dickey as beautiful or even pretty, but many men found her irresistible. Her closest male friend, Pat Powell, a former *ABC* and *Time/Life* correspondent, said that the basis of her attractiveness "was her energy." However, her energy made some people uncomfortable, recalls her friend Bernie Yoh. "She came down to a village (in Vietnam)



Photo: courtesy *Leatherneck Magazine*

Throughout her career, she always insisted on being treated no differently than the men she covered.



Photo: courtesy *Leatherneck Magazine*

where I was operating. I had to leave for about 10 days and during this time she had no one to talk to in English. When I returned, I brought her cigarettes — she'd smoke anything — and some canned food and beer. When we had dinner, she was talking, smoking and eating, all at the same time. She was alive, all right. Too alive for some people. She came into a room and you knew she was there. She laughed a lot and didn't talk. She shouted."

She had many affairs, often with younger men. She described her sexual exploits to friends with both candor and a sense of locker room bravura. To Dickey, sex, like war, was an adventure.

The essence of adventure, she believed, "is the certainty of uncertainty." But if she was an adventurer, she was a modest woman who kept her own accomplishments in perspective. Nor did she ever lose touch with the daily struggles of ordinary

20 YEARS OF WAR

Iwo Jima, 1945

Chapelle first experienced combat in Iwo Jima, fighting her way through bureaucracy and males who didn't believe she could do the job.

Hungarian Revolution, 1956

Captured by Soviet troops, she was held for 52 days, 38 of them in solitary confinement.

French Algerian War, 1958

In 1958 she spent several months in the desert with Algerian rebels.

Cuba, 1959

Dickey was arrested by the U.S. Coast Guard off Florida as she headed for Batista's Cuba aboard a Castro raider boat. She later traveled to Cuba in disguise and spent three weeks with Castro.

Other Trouble Spots

In 1959 she went to Lebanon with the Marines, then to Okinawa, then to Kashmir to cover the border dispute, then to the Dominican Republic for the revolution and then to Korea, where she parachuted with U.S. Special Forces on guerrilla-training exercises.

Vietnam, 1962

Now in her forties, Dickey jumped with Vietnamese airborne troops, and went into combat with U.S. Marines in Vietnam. On 4 November 1965 Dickey Chapelle died near Chu Lai, the victim of a land mine and her last war.

— S. Max

women. She maintained that a woman with five children faced far more uncertainty and adventure every day than she did.

"Under Fire"

Her career as a photojournalist and war correspondent didn't really begin until 1945, when she was sent to the Pacific Theater of Operations. She covered the bloody Marine assault on Iwo Jima, and it was the turning point in her life. She saw combat close up and for the first time added to one of her dispatches the words "Under Fire" after the location and dateline.

In the decades that followed, she covered most of the globe's major hot spots and conflicts. Despite the recognition that she received, she rarely worked as anything but a freelancer. Never a "team player," Dickey was always too independent to work on a sustained basis for large news organizations.

Her detractors accused her of becoming too emotionally involved in the stories she covered, of crossing the line between observer and participant. They point to the fact that she gave up her role as a reporter during the Hungarian Revolution and tried to smuggle penicillin to the Freedom

Continued on page 122

BUILDING A BETTER M16

*Eagle Arms' EA15E2 Steps In
Where Colt Fears to Tread*

Text & Photos by Peter G. Kokalis

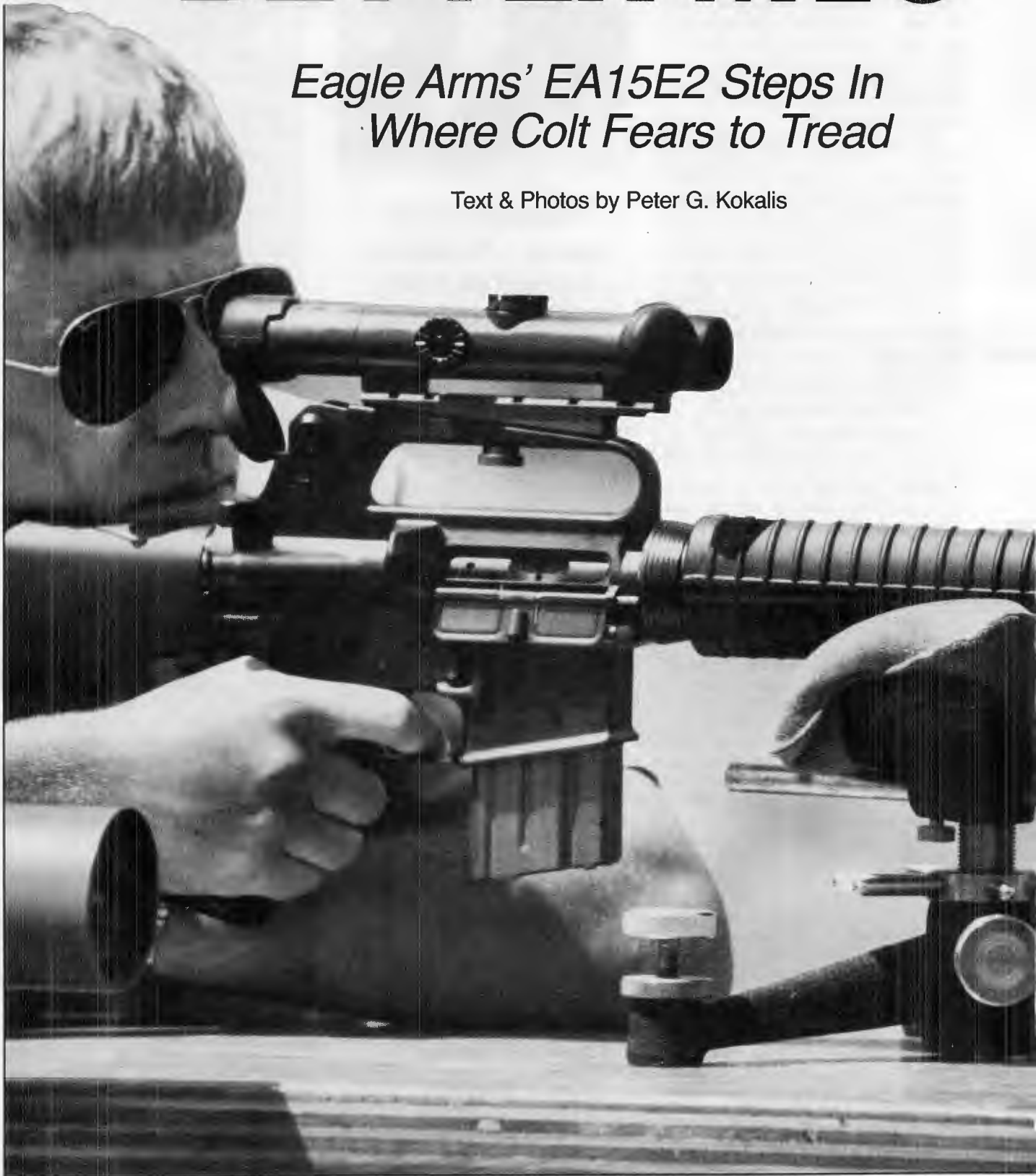

BORN in a swirl of unending controversy, the latest spate of unjustified innuendoes against the M16 series have focused on its semiautomatic-only civilian versions. To Metzenbaum's maggots and their all-too-eager and incredibly ignorant anti-gun dupes in the media, semiautomatic-only versions of any modern military small arm are "assault rifles."

No matter that by definition an assault rifle must possess selective-fire capability. No matter that these semiautomatic-only firearms have been designed in accordance with BATF regulations to preclude their ready conversion to full-auto. No matter that the FBI's 1987 Uniform Crime Reports indicate that police slayings have actually dropped 22 percent from 1978, a time when military-style semiautos were not commonly available. No matter any amount of factual data or any degree of logic whatsoever.

The only thing that does matter is that those who machinate unceasingly to destroy the Second Amendment have seized upon a new buzzword and category of firearms they feel are vulnerable as a result of their superficial similarity to military full-auto weaponry. As a consequence, we find that pistol grips, flash hiders, bayonet lugs and large-capacity magazines have suddenly become a veritable incarnation of evil and violence to the Brady Bunch and their salivating myrmidons.

Eagle Arms, Inc. (Dept. SOF, 131 East 22nd Avenue, Coal Valley, IL 61240, phone: 309-799-5619) has recently introduced a well-

executed, semiautomatic-only (no selective-fire bolt carriers, hammers, triggers, selectors or disconnectors are used in the manufacture of the Eagle Arms rifles) clone of the M16A2. In so doing, their attitude (unlike that of the new Colt Firearms Company, Inc.) toward Sarah Brady and Handgun Control, Inc. is more than a little reminiscent of Rhett Butler's response to Scarlet O'Hara in *Gone With the Wind* — "Frankly my dear, I don't give a damn." Both their attitude and products deserve our support and applause.

SOF was provided with both an EA-15E2 H-BAR (Heavy Barrel) Rifle and EA-15E2 Carbine for test and evaluation. Equipped with a 20-inch heavy barrel, overall length of the EA-15E2 H-BAR rifle is 39.5 inches. The weight, empty, is 8.56 pounds. With its 16-inch barrel and the buttstock collapsed, the EA-15E2 Carbine has an overall length of about 32 inches. Its weight, empty, is approximately 6 pounds.

EA-15E2 upper and lower receivers are forged and precision machined from high-tensile-strength 7075 T6 aluminum alloy. Both are hardcoat anodized to MilSpec MIL-A-8625 Type II Class 2. This finish closely duplicates the Sandstrom 9 gray baked paint finish encountered on most Colt-manufactured M16s. All of the steel components have been phosphate-finished.

Although it has no selective-fire option, the EA-15E2 has most of the M16A2's features along with both some important and minor differences. Starting at the muzzle and working rearward, the EA-15E2 H-BAR shares the following features in common with the M16A2 — all of which are modifications and im-

provements of the M16A1:

The M16A1's famous bird-cage flash suppressor remains, sans the sixth port on the bottom which was deleted to slightly reduce muzzle climb during burst-fire and diminish position disclosure when firing prone in desert climates. There has been no change in the flash signature as a consequence of this alteration. The lock washer used to retain the M16A1's flash suppressor has been replaced by a set of peel-washers so that the unit can be rotated either to the right or left, for right- or left-handed shooters, respectively.

The front sight post is square. This change was requested by USMC marksmanship experts who believe it provides an improved sight picture.

Held by a tapered slip ring, the round A2-type handguards are more comfortable than the M16A1's triangular cross-section forearms, and much easier to remove and install.

The 800-meter rear sight was also requested by the Marines, who first saw it on the old M16 light machine gun. It is a flip-type peep with two apertures calibrated for M855 ammunition. Flipped forward, the large aperture (0.197 inches in diameter), marked "0-2," is brought into view for ranges out to 200 meters, low-light levels or moving targets. When firing within this range, the elevation knob would be set to "8/3" with the sight base at its lowest position — after the initial elevation zero has been adjusted by means of the front sight post. Flipped back, the peep sight brings the small aperture (0.070 inches in diameter) into view for ranges of 300 to 800 meters. A small index line matches up with the windage calibration lines on the back of the sight base. One audible click of the windage knob moves the point of impact 0.4 minutes right or left. With the small aperture in use, the elevation knob should be set at the range required: "8/3" low for 300m, "4" for 400m, "5" for 500m, "7" for 700m and "8/3" high for 800m. Audible clicks between the main settings will raise or lower the elevation by approximately one minute of angle.

The upper receiver forging has incorporated a case deflector to the rear of the ejection port which throws empty cases clear of left-handed shooters. In semiautomatic fire, the ejection pattern has been altered 5 or 6 degrees forward by this deflection hump.

The ejection port dust cover's spring-loaded retaining catch has been strengthened and enlarged. The dust cover's latch-pin is no longer retained by the slip-washer that so often disappeared at the wrong time.

Integral ribs surround the magazine release button on the right side of the lower receiver forging to prevent accidental release of the magazine.

Fabricated from foam-filled, high-impact plastic, the A2-type buttstock is 3/8-inch longer than that of the M16A1 and



When equipped with an optical sight — in this instance the Steiner 4x24mm NATO scope — and match-grade ammunition, such as the Black Hills 60-grain Soft Point, the EA-15E2 H-BAR will consistently group under 1 MOA from the bench.

EAGLE ARMS EA-15E2 SPECIFICATIONS

| | |
|-------------------------------|--|
| Caliber: | .5.56x45mm NATO (.223 REM). |
| Operation: | Gas — direct impingement on the bolt carrier, no piston; rotary bolt with eight locking lugs; semiautomatic-only. |
| Feed mechanism: | 20- and 30-round, staggered-column, detachable box-type magazines. |
| Barrel: | Six grooves with a righthand twist of one turn in 9 inches. |
| Barrel length: | H-BAR — 20 inches; Carbine — 16 inches. |
| Overall length: | H-BAR — 39.5 inches; Carbine — approximately 32 inches with stock collapsed. |
| Weight, empty: | H-BAR — 8.56 pounds; Carbine — approximately 6 pounds. |
| Sights: | Front: protected square post adjustable for elevation zero; rear: flip-type peep with two apertures, 0.197-inch for 0-200m and 0.070-inch for 300-800m, knob adjustable for windage and elevation, calibrated for M855 ammunition. |
| Finish: | High tensile strength 7075 T6 aluminum alloy upper and lower receivers hardcoat anodized to MilSpec MIL-A-8625 Type II Class 2; steel components phosphated. |
| Furniture: | Round A2-type handguards; Lone Star Ordnance pistol grip with trapdoor accessory compartment; buttstock fabricated from foam-filled, high-impact plastic. |
| Price: | Suggested retail: H-BAR — \$850; Carbine — \$800; both complete with one 30-round magazine, sling, USMC TM 05538C-23&P/2 manual and one-year warranty. |
| Manufacturer: | Eagle Arms, Inc., Dept. SOF, 131 East 22nd Avenue, Coal Valley, IL 61240, phone: (309) 799-5619. |
| T&E Summary: | Well-executed and reliable; H-BAR version capable of ¾ MOA with 60-grain projectiles; has all features of M16A2 series (sans selective-fire capability) with additional improvements. |



EA-15E2 H-BAR rifle, field stripped.

this has increased the length of pull to 13 1/3 inches. The buttplate's edges are no longer rounded and the entire surface, not just the butt-trap, is deeply checkered.

Unlike the Colt AR-15A2 which employs a screw/pin system, the EA-15E2's front hinge pin (connecting the upper and lower receivers) is a captive, push-pin pivot as found on M16 selective-fire weapons.

The M16's frightening and menacing bayonet lug — which while it serves no "sporting purpose," certainly serves no criminal purpose either — has been retained and will accept both the M7 and new M9 "multi-purpose" bayonets.

In addition to its lack of selective-fire capability, the EA-15E2 H-BAR differs in some other areas from the M16A2. The heavy barrel tapers in diameter from 0.73 inches at the muzzle up to 0.88 inches just in front of the chamber. This largely explains the weight increase of more than a pound over the M16A2. Eagle Arms barrels are turned from Wilson blanks and have 6-groove bores with a right-hand twist of one turn in 9 inches. This rate of twist duplicates that used on the Steyr AUG and represents the best compromise between the M16A1's 1:12-inch twist and the M16A2's much faster 1:7-inch twist (actually designed to stabilize the long M856

tracer projectile) as it will stabilize bullets ranging in weight from 55 to 62 grains.

While it retains the A2-type button-like shape with concentric rings, the EA-15E2's forward assist has a diameter of only 0.62 inches while that of the M16A2 measures 0.75 inches in diameter. Another trivial difference is the absence of selector markings on the right side of the EA-15E2's lower receiver.

More important is the EA-15E2's pistol grip which is manufactured by Lone Star Ordnance (Dept. SOF, P.O. Box 121006, Arlington, TX 76012; phone, 800-482-3733) and has a useful trapdoor accessory compartment.

The EA-15E2 H-BAR is a match-grade rifle and its accuracy potential can only be determined from the bench using optical sights. On hand was a Steiner 4x24mm NATO scope which was attached to the rifle with an A.R.M.S. (Dept. SOF, 230 W. Center St., West Bridgewater, MA 02379) M16A1/A2 Universal Top Scope Base. This A.R.M.S.

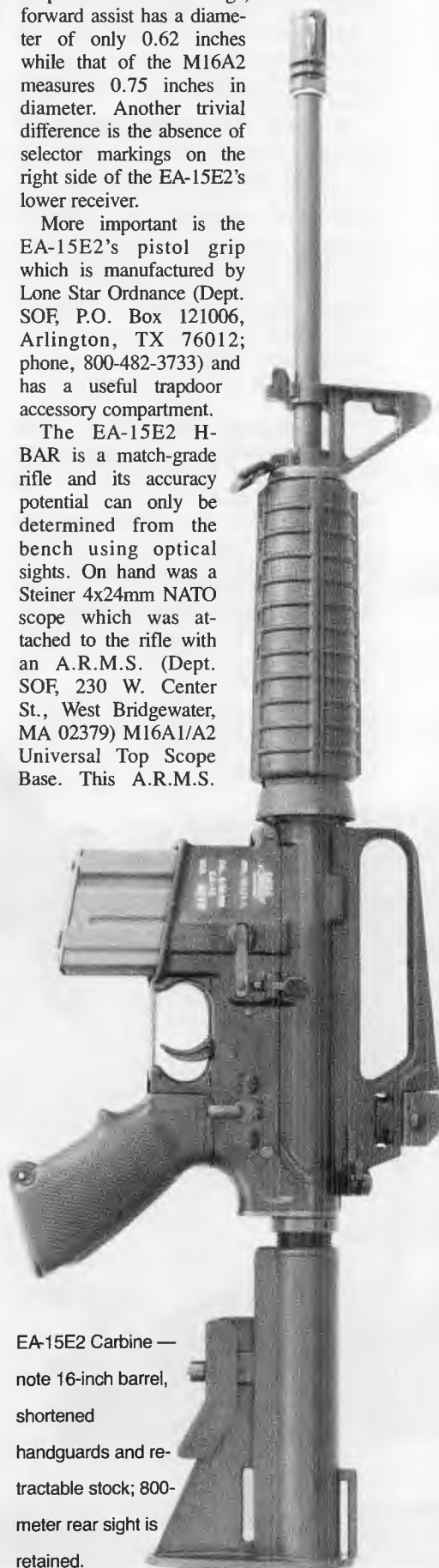

EA-15E2 Carbine — note 16-inch barrel, shortened handguards and retractable stock; 800-meter rear sight is retained.

base accepts both Weaver and NATO STANAG military scope fastenings. It features a special bolt and self-locking thumbscrew that assures retention of zero through repeated removal and a wide-angle "TV screen" iron sight see-through.

The rugged Steiner scope (distributed by Pioneer & Company, Inc., Dept. SOF, 216 Haddon Ave., Westmont, NJ 08108, phone: 800-257-7742) uses the traditional German military reticle pattern. This consists of a single thick, pointed post at the bottom of the field of view with horizontal side bars and stadia lines. Although an excellent combat format, especially in subdued light, it is less than ideal for punching paper.

Black Hills Ammunition (Dept. SOF, 3401 South Highway 79, Rapid City, SD 57701, phone: 605-348-5150) provided 5.56x45mm NATO ammunition in four bullet weights for our test and evaluation of the EA-15E2 Carbine and H-BAR Rifle: 52-grain Jacketed Hollow Point (JHP), 55-grain Full Metal Jacket (FMJ) and Soft



Lone Star Ordnance pistol grip with its useful trapdoor accessory compartment is a standard feature on all the Eagle Arms EA-15E2 rifles.

Point (SP), and 60-grain SP. Muzzle velocity averaged approximately 3,000 fps with all four bullets. Range conditions were typical of the Lower Sonoran desert where the tests were conducted: intense heat with associated mirage and gusting winds.

There was an inverse correlation between the bullet weight and the group dispersion. As the projectile weight increased, the group dispersion decreased. At 100 yards, the light 52-grain HP bullet yielded groups averaging 2.0 inches. Both the 55-grain SP and FMJ bullets impacted on paper with groups averaging 1.75 inches. Most astounding was the 60-grain SP bullet which shot consistently under an

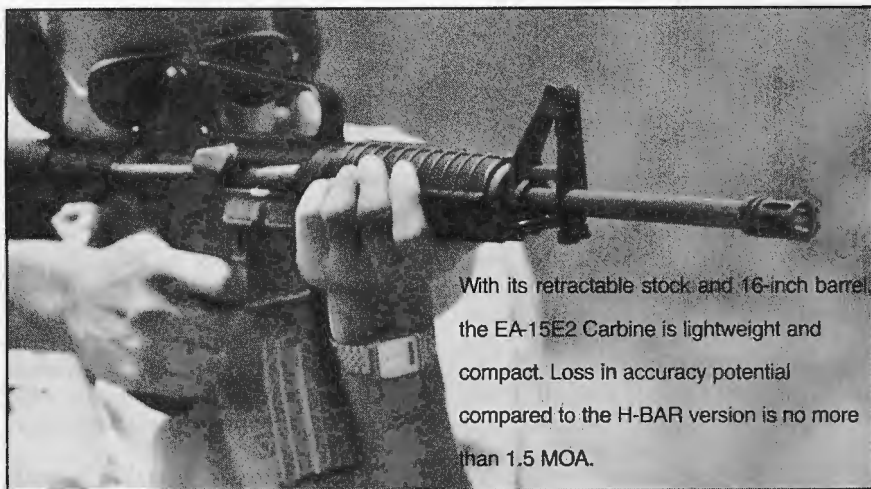

With its retractable stock and 16-inch barrel, the EA-15E2 Carbine is lightweight and compact. Loss in accuracy potential compared to the H-BAR version is no more than 1.5 MOA.

METHOD OF OPERATION

With a gas action taken from the Swedish Ljungman AG42 rifle and a trigger mechanism based on that of the M1 Garand, all rifles in the M16 series, including the EA-15E2, operate, briefly, as follows. After ignition of the primer, the projectile passes the barrel's gas port, permitting gas to flow back through a stainless steel tube and a so-called bolt-carrier "key" into the hollow interior of the bolt carrier. As the carrier moves rearward, a cam slot cut into the carrier turns the bolt's cam pin, which causes the bolt to rotate clockwise, freeing the eight locking lugs from their abutments in the barrel extension. The carrier's momentum draws the bolt rearward at a slightly reduced velocity.

After the extractor has withdrawn the empty case from the chamber, a spring-loaded bump-style ejector protruding from the left side of the bolt face rotates the case around the extractor claw and out the ejection port of the upper receiver body. The bolt carrier assembly continues rearward, compressing the recoil spring and cocking the hammer.

The buffer and recoil spring return the carrier, and a fresh round is stripped from the magazine. All forward bolt motion stops after the round is chambered. The carrier continues forward to contact the rear face of the barrel extension and its cam slot turns the cam pin which rotates the bolt and its lugs counter clockwise into the locked position.

While much criticized by those who sought, for whatever reasons, to find fault with the M16 from muzzle to buttplate, the truth is that this system of gas operation (also employed in the French MAS 44, 49 and 49/56 rifles — see "Vive Les Guns," January '90) works, and quite well, if properly maintained.

— Peter G. Kokalis

inch, with some groups going 0.75 MOA. That's sniper-grade accuracy on anyone's score card and truly spectacular for a gas-operated rifle. There isn't a single Kalashnikov out of the more than 50 million produced that will shoot even 2. MOA. AKs average between 4 to 8 MOA — and 6 MOA or under only if you're lucky.

Caliber 5.56x45mm NATO JHP and SP bullets lighter than 55 grains (such as Federal 40-grain Blitz round) should usually be avoided in barrels with 1:7-inch and 1:9-inch twists. Not only do they degrade the rifle's accuracy potential, but — if the rifling is sharp and the barrel heats up — they may shed their jackets shortly after leaving the muzzle, with only the core remaining to travel down range. At distances much beyond 25 yards, the residual core may not strike the target. Law enforcement agencies are well-advised to test for this phenomenon before fielding ammunition with such light bullets.

Trigger pull-weight on the EA-15E2 Carbine and H-BAR rifle were single-stage and a crisp and consistent 5.25 and 5.5 pounds, respectively. More than 1,000 rounds were fired through these two firearms. As there is always a trade-off, the EA-15E2 Carbine's shorter, lighter barrel and retractable stock added about 1 to 1.5 inches to the group dispersion obtained with the EA-15E2 H-BAR. There were no stoppages of any kind throughout the course of our test and evaluation.

Suggested retail prices of the EA-15E2 Carbine and H-BAR Rifle are \$800 and \$850 respectively. This includes a 30-round magazine, a sling, USMC TM 05538C-23&P/2 manual and a one year warranty. This is approximately \$200 less than the new Colt AR-15A2 "Sporter" and, in addition, you get a vicious-looking bayonet lug and a large capacity magazine.

Reliable and capable of superb accuracy when provided with match-grade ammunition of the proper bullet weight, the Eagle Arms rifles are excellent examples of an endangered species that has become the totally unjustified pariah of the anti-gun nuts. ❧

SOF TRAINS CONTRAS

Continued from page 73

of limited ammo). Morning couldn't come soon enough.

The next two weeks went by quickly, and the Tigers were turning into a decent fighting unit. Bermudez mentioned that the COE would be back in about a week now, and wanted us to be ready to train them. That night was the last good sleep we would see for the next 72 hours.

The next morning began as usual, except that the cook shack burned down. By 0700, the roof was like a torch. Since there was otherwise little to do, this turned into quite a social event. The contras stood around chanting, "The cook shack is burning, the cook shack is burning..." No shit. When a unit arrived from the field, they also joined in the chant. Anything to break up the monotony!

Around 0900, we heard what sounded like an artillery round, or maybe a bomb going off several clicks away. As the morning progressed, so did the explosions, only now they were getting closer. By noon, we heard an impact no more than a couple of clicks away. This was something new. A general discussion broke out speculating on what the hell was going on.

We had just started on our beans and rice when the air tore apart with an explosion about 300 meters from our camp. There was no doubt in our minds now — we had all heard this one before: a 122mm "Katushka" rocket. The next thing we heard were nine more missiles screaming down on us. While a 122mm has a warhead of about 40 pounds of high explosives and makes a good boom, it doesn't have an effective fragment dispersal pattern. Good thing for us, as our tent was on high ground with nothing at all between us and the crashing missiles.

If it had been artillery, we would have been covered with iron by now. Still, what the hell were we going to do? There wasn't a bunker or slit trench anywhere in the camp. It must take about three minutes to load a battery of Katushka rockets, because that was how long we had before the next 10 rockets came pounding down. By the time these hit, we were down in a little ravine behind our tent — all except RKB, that is. Where the hell was he? Well, RKB had a bad habit of sitting around in the tent in his shorts, and today was no exception. So as the rockets were crashing down on us, RKB was in the tent putting his pants and boots on — probably with a smile. Finally, he came out and slid down behind us.

The rocket barrages were coming in three-minute intervals now, but had shifted away from our position toward the center of camp. It had been 20 years since I was rocketed in Vietnam — I wasn't liking it any more now than I did then. The first thing we needed to do was collect our combat gear and check the camp for

injured. After a quick look, we were relieved to find that none of our Tigers had been hurt.

The only problem was that everyone was running around like chickens with their heads cut off. Bermudez came over on a casualty check about this time, saying there had been several killed at Camp Las Vegas, and several injured at another. He said the Sandinistas had crossed the Rio Coco, near Yamales, and were headed this way. Great! Now what? As soon as we asked, it came: more Katushkas. For the next 30 minutes, we were pounded mercilessly. When things calmed down a little, we thought it would be a good idea to move a little further away from the bull's-eye.

If the Sandinistas' intentions were to overrun the camp, we thought it would be best to position ourselves on the perimeter.

along the Rio Coco, there wasn't one. The Sandinistas had brought the rocket launchers in by helicopter, then put them in across the river, about five miles away.

Bermudez showed up the following day and said we would have to cancel our training for the week. We decided to go back to Tegucigalpa to see if we could locate a more secure training area. Giving back our UZIs was another part of the deal. Great! Topaz was allowed to stay behind, however, as Bermudez needed medical personnel.

[Note from RKB: Since we were going to pass through Honduran checkpoints we had to turn in our UZIs. Bermudez directed Mario del Amico, a Cuban-American who had arrived at our camp and supervised a squad of Honduran troops in unloading 500,000 rounds of PRC-manufactured

This guy was something else: coke bottle sunglasses, some type of black "Death from Above" T-shirt covering a belly that protruded over his belt, fat cigar and .45 auto in a fastdraw holster. A "Mr. Combat ..."

The comandante liked our idea, and sent a couple of men with us to point the way. Rockets began crashing down again. Heading north into a valley, we ran into 30 or 40 civilians, all scared shitless. Another hour up the trail, it started to dawn on us that our guides had no idea where the perimeter was, or even if there was one. At any rate, it would be dark soon, so we pulled back to a gully and set up a defensive position.

We found we had 120 rounds of 9mm each, and eight hand grenades. Our two contras said they were going back to camp — they didn't want to miss supper, and besides, it might rain. The thought of spending the night with a motley gang of gringos may also have been a factor.

If we did get into it with the Sandinistas, we would be in deep shit. The rocketing lasted all night and nobody slept very well. At 0600, RKB noticed that there weren't any roosters — I think he kind of missed them.

The camp was in the same shape as when we left, and the Tigers still hadn't lost any men. Asked why they hadn't dug trenches, Bermudez said the soldiers didn't like them because they were too much like graves. I thought I had heard every possible excuse to get out of digging trenches, but this one took the cake.

Topaz reported there had been a total of about 10 killed and 40 wounded in the rest of the camp. Amazed there were not more, we began wondering what had happened to the Sandinista ground attack. Later we found that except for a few skirmishes

7.62x39mm ammo to accompany us. This guy was something else: coke bottle sunglasses, some type of black "Death from Above" T-shirt covering a belly that protruded over his belt, fat cigar and .45 auto in a fastdraw holster. A "Mr. Combat" — arrogant, pompous, and fat. Bermudez told him to provide security for us back to Tegucigalpa but he took off never to be seen again. I owe you a punch in the nose you fat fuck.]

At 0400 the next day, we finally pulled into Tegucigalpa. This ride made the previous one seem first class. The truck broke down twice and everything, including us, was covered with 2 inches of dust. It was hell. Then we were off to the Alameda motel. If RKB hadn't known the desk clerk from previous trips, we probably couldn't have gotten rooms. As it was, we were back in civilization, of a sort — it was the first time in weeks we had eaten off plates!

Meanwhile, RKB was making calls to the States trying to find out why no one down here knew we were coming. After hearing some details of what had transpired, Singlaub said he would get back to us.

I had mentioned to Benson earlier that there was a shortage of belt links for the M60s, and no sights for the 82mm mortars. We both knew where we could get these: from our contacts in El Salvador. We talked this over with RKB, who agreed the trip was a good idea. The next day, Benson and I were gone.

An hour after leaving Honduras, we were in a cab on our way to Ilopango, home of the Salvadoran air force and Airborne Battalion. Waiting there in the officers mess was Jack Thompson, who had been with us at Singlaub's home, but couldn't accompany us at the time. A good soldier and a fine instructor, we were pleased to know he would be with us on the return trip to Honduras. Benson knew where to go for mortar sights, and Thompson had a contact for links, a Captain Castro.

Castro proved happy to help; two minutes after finding him we had two 20mm ammo cans full of new M60 links in the back of the vehicle. Thompson came by later, saying the FDN had a plane going to Honduras tomorrow. Not only could we hitch a ride back with them, we could also solve the problem of getting our new toys past any suspicious customs officials. The tired looking FDN Cessna had no room for our links as it turned out, but no problem, we were told they would be sent down on a later flight. They never made it.

Waiting back at the Alameda motel in Honduras was I.W. Harper, the former CIA demo expert. That night, RKB filled us in on what had been happening since we left. Some of the FDN had tried a power play. They said our team was to return to the United States immediately. RKB called Singlaub, who we assume called Ollie North. The result was that the mix-up got straightened out, asses got chewed, and the FDN suddenly became very cooperative. We even got some more UZIs.

RKB said everything was a "go" at Camp Las Vegas, and that the COE would be waiting for us when we got there. When we arrived, we were taken to Bermudez's headquarters. We would be staying in the guest tent for the night. The guest tent? Things had changed around here since our first trip.

The next morning, Bermudez called us in for a briefing on the FDN situation in the field, and asked us for suggestions. We talked for three or four hours about likely targets the COE might hit. One was the hydroelectric plant which supplied electricity to Managua, and another was the oil storage tank farm at Bluefields. With the training we were going to give the COE, both could be destroyed. Comandante Bermudez was very interested.

That night, with the whole team together for the first time, it looked as if we were finally going to get to do what we came down here for. Unfortunately, that was not to be the case.

We woke in the night to the sound of heavy shelling in the distance. We didn't know who, but someone was getting pounded. One of the hardest things in war is not knowing what's going on. Near 0900, someone came by to say the Sandinistas were hitting the FDN position near the Rio Coco and were sending troops across the river. The COE would be moving out again ... Great.

The Sandinistas had crossed the river in force, and were supposed to be heading this way. Rocket attacks were expected for the night. Three contras came by and asked if we would go with them to a commo relay station on top of the mountain behind us. Why not? At least from there we would be able to see what was going on. Two hours later, we were at the station watching Yamales burn to the ground. By the time we left the next morning, 430 rockets had been fired.

Back at Camp Las Vegas, we were told the Honduran army would be moving in large numbers of troops while the FDN was to evacuate. This was a full scale attack into Honduras; thousands of Sandinista troops were crossing over. The FDN had perhaps 8,000 men fighting at Rio Coco. It was a little tough to know how much of this was true, and how much was rumor, but one thing was clear: there were no combat troops in our camp.

Everyone still around was packing up because it was time to get out of Dodge. The place they moved us to was about 10 miles to the north, an old FDN surgical hospital and maternity ward, complete with 50-odd pregnant women. It looked as though we were out of a job for the time being. A river of wounded began flowing

into the place, a grim reminder that there was one hell of a fight raging out there. While Topaz and I helped out with the wounded, the rest of the team waited it out in frustration.

It soon became clear that we weren't going to be able to complete our mission. Since Thompson and Harper had arrived late, they would be staying a while longer. For the rest of us, it was time to go.

The following day, we loaded up and headed back to Tegucigalpa. No one had much to say on the way back. After turning in our UZIs at the FDN headquarters that night, we got an update and headed back to the Alameda motel. We were on our way home the next day. Even out of Honduras now, our luck seemed to be following us around. The plane had mechanical problems, and we had to set down for repairs. RKB got hung up in customs for an hour in the States — seems they wanted to talk about where he had been, being a soldier of fortune and all. It soon came time for us to go our separate ways. The mission was over. We said our goodbyes.

Were our efforts worthwhile? Depends on your point of view. If we helped save some contras and indirectly helped take out some Sandinistas, then yes, you're damned right it was worthwhile! ✕

COMBAT CRAFT

Continued from page 35

Through. Each has its application.

A Standoff Attack allows fewer friendly casualties, and is implemented by mortars, rockets, RPGs and LAWs or patrol mortars. Area targets such as barracks, repair facilities, ready ramps for aircraft, POL and ammunition dumps are vulnerable to this type of attack.

Success of a Raid-In-and-Out depends on the attacking force being able to penetrate enemy security and hold the breach in order to withdraw through it the same way they came in. This requires a larger party, as security elements must be able to hold the withdrawal route against enemy counterattacks. A Raid-In-and-Out can be used against POL and ammo dumps, hydroelectric plants, airfields and repair facilities using RPGs and LAWs, explosives and small arms as appropriate.

A Raid Through is often used by a small force against a precise target. It is accomplished by penetrating the target's outer perimeter, destruction of the target and withdrawal by continuing straight through the enemy installation. Security elements should maintain sustained fire once the attack has begun in order to fix attention on the outer perimeter and away from the raiding party. At a given time, the security element breaks contact to secure a

withdrawal route. A Raid Through is ideal for small airfields, command and control facilities, POL facilities, and electrical generation plants.

Withdrawal: Upon completion of the attack, all elements return to an Objective Rally Point (ORP), which can be the same as the Final Release Point (FRP—the nearest point the team is staged prior to the attack). The rally point must be known to all team members. Alternate rally points and the withdrawal route should also be known by all, and the route from the ORP to the Withdrawal Point should be different than that used to approach the objective. Security elements should have already set up explosive ambushes to slow the lead elements of any pursuing enemy.

Withdrawal can be across country (assuming a support base within the local population), by air or by sea. Team OpSec is still paramount. It does the team no good to be successful on target and then be ambushed prior to extraction.

Raids require swift penetration with a minimum of personnel. Each man is well armed and carries as much ordnance as possible. The action on target is swift, violent, and usually targets soft, critical elements of the enemy's infrastructure. The key elements to a successful raid are surprise, speed and initiative. Raids may not in themselves win wars, but they can deny the enemy the means to win. ✕

JAILBREAK

Continued from page 47

knew any attempt to escape would be futile. He watched in quiet agony as the G2 man found his name in the book, then as he looked up at the sign, and finally, back down at the passport. A moment later he left the booth for a moment and returned with four plainclothes security men. They asked Kurt to come quietly with them, telling him that it was "routine."

It was anything but routine. That night, alerted by Muse's 16-year-old daughter, the other conspirators and their families — 26 people in all — fled to the U.S.-controlled Canal Zone and requested asylum. Kurt, meanwhile, was interrogated constantly for two-and-a-half days and not permitted to sleep. It soon became clear to him that they didn't know that he was behind the clandestine radio. It was only after they discovered leases at his home for the apartments in which the transmitters were located that he realized that the game was over. Confident that his friends had had time to escape, he confessed, "I'm Radio Libertad."

The interrogator was so shocked he almost fell out of his chair. He jumped up and hurried out of the room and soon the entire police (DENI) headquarters was in an uproar. A short time later, Lieutenant Colonel Nivaldo Madrinan, the head of DENI, came in to get a firsthand look at

Muse.

"Do you suffer from high blood pressure?" Madrinan wanted to know.

"No."

"How about insomnia?"

"No, sir," responded Muse.

"Well," said Madrinan menacingly, "you're soon going to have both. Mark my words."

He wasn't joking. In the days that followed, Muse was moved from prison to prison, finally landing in the Modelo several weeks later. Although never tortured, Muse saw and heard the prison guards at the Modelo torture political opponents of the regime. Among the first victims were antigovernment demonstrators arrested in the wake of the 7 May 1989 elections, which were annulled by Noriega. They were routinely lined up against one of the prison walls, four at a time, and beaten on the back, buttocks, and legs with rubber hoses. Two prisoners were hung by their handcuffs from a basketball hoop in the prison courtyard and beaten by three jailers with rubber hoses containing metal filaments. A large American flag was draped around one of the men, now a Panamanian senator, while one of his torturers screamed at him, "Now call your American friends. See what they can do for you now."

But worse was to come. After the abortive 3 October coup, many of the plotters were incarcerated in the Modelo Prison. The rebel officers were ordered to

take off their T-shirts and cover their heads with them. Then they were beaten about the face with fists, hoses, and truncheons until the T-shirts were red with blood. Over the weeks that followed, rebel officers and men were systematically tortured every night, generally from midnight to three in the morning. "The interrogators would arrive making intimidating noises, their footsteps echoing through the prison as they hit the bars with their truncheons," says Muse. "After that, the torture would begin. Let me tell you, the sound of a man being tortured is indescribable."

Muse's arrest and incarceration presented the United States with a number of problems. Although an American citizen, Muse had been acting independently and was not, as some reports later suggested, a CIA agent. The other six conspirators were all Panamanian citizens. The Noriega regime initially accused Muse of being an "employee of the U.S. State Department," but they soon realized that they had been had by a group of gifted amateurs, and this only made them more angry.

Since Muse's wife, Anne, worked as a teacher in the Canal Zone, he was technically a U.S. dependent, and therefore entitled to due process and certain protection under the 1979 Panama Canal Treaties. United States representatives met with him on almost a daily basis at the Modelo Prison, and began pressuring the Panamanian government to release him.

CEP, INCORPORATED

Experts for Hard-and-Fast Insider Information

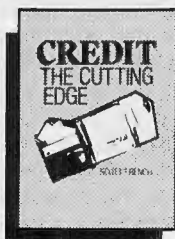

CREDIT: The Cutting Edge Scott French

A clean credit rating is your key to power and financial muscle. Read about the 70 least-known credit facts, getting cards with out a credit check, dealing with collection agencies and the top credit card crimes. 8 1/2 x 11, softcover, 264 pp.

\$25.00

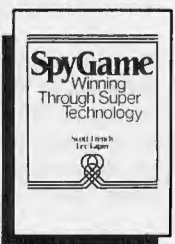

SPYGAME Winning Through Super Technology Scott French and Lee Lapin

SpyGame: exotic weapons, infrared monitoring, the legalities of surveillance, the rocket pistol and reading minds. See in the dark and access secret data. This book has the most up-to-date info. 8 1/2 x 11, softcover, photos, illus., 520 pp.

\$30.00

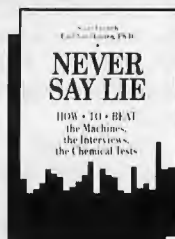

NEVER SAY LIE How to Beat the Machines, the Interviews, the Chemical Tests Scott French and Paul Van Houten, Ph.D.

Find out how job-screening firms, the FBI, IRS and others use lie-detection methods. Here is the knowledge you need to beat the tests that can ruin your career and your life! 8 1/2 x 11, softcover, photos, 168 pp.

\$19.95

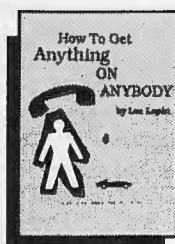

HOW TO GET ANYTHING ON ANYBODY Lee Lapin

Called "possibly the most dangerous book ever published" by Peter Laufer, NBC News, this best-seller is packed with advanced investigative and surveillance techniques. You won't believe the possibilities! 8 1/2 x 11, softcover, 272 pp.

\$30.00

| | | | | | | |
|---|---------|-------------------------------------|-------------------------------|---|---------------------------------------|-----|
| <input type="checkbox"/> Credit | \$25.00 | <input type="checkbox"/> MasterCard | <input type="checkbox"/> VISA | <input type="checkbox"/> Check or Money Order | <input type="checkbox"/> Free Catalog | OJS |
| <input type="checkbox"/> SpyGame..... | \$30.00 | Card No. _____ Exp. _____ | | | | |
| <input type="checkbox"/> Never Say Lie..... | \$19.95 | Name _____ | | | | |
| <input type="checkbox"/> How to Get Anything on Anybody | \$30.00 | Address _____ | | | | |
| <input checked="" type="checkbox"/> Shipping & Handling | \$3.50 | City _____ State _____ Zip _____ | | | | |
| TOTAL ENCLOSED _____ | | | | | | |

P.O. BOX 865-OJS • BOULDER, CO 80306 • (303) 443-7250 • CALL TOLL FREE 1-800-642-8300 EXT. 82

The Strongest Lasers...

the Strongest Mounts



New BSL-1 Laser Sight

- Size: 2 3/4" x 3/4"
- Laser: 5mW/670nm
- Finish: Blue or Stainless
- Warranty: Lifetime Repair or Replacement
- Weight: 2.25 oz.
- Spot: 2' @ 200 yds.
- Power: Duracell T175

(Actual Size)

Interchangeable Mounting Options

| | Under Barrel | Over Barrel | Laser to Scope |
|---------|-----------------|----------------|-------------------|
| Handgun | ✓ | ✓ | ✓ |
| Rifle | ✓ | ✓ | ✓ |
| Shotgun | ✓ | ✓ | ✓ |

Ask your dealer or call

1-800-433-2909

B B-SQUARE

Laser Sights and Mounts

Ft. Worth



UNIVERSAL MILITARY OUTFITTERS

P.O. Box 194 — Bay Ridge Station
Brooklyn, New York 11220
N.Y.S. (718) 375-6350
TOLL FREE: 1-800-521-2124

"BIGGER AND BETTER THAN EVER"

GI BDU SETS —

4 pocket shirt, 6 pocket pants

AVAILABLE IN THE FOLLOWING PATTERNS:

Woodland Camo 50/50 NYCO, Camo Ripstop, Tiger Camo, Day Desert, Urban Camo, SWAT Black, OD Ripstop \$49.50 set

Sold Separately at \$26.00

GI M65 Field Jacket — Orig Issue Only

Camo, OD, Black \$44.95

GI M65 Field Jacket Liner

OD, Black \$16.95

GI MA1 Flight Jackets — "ALPHA"

Sage Green, Black, Navy Blue \$44.50

Cammo Short Sleeve T-Shirt — 2 for \$10.00

Military Berets — Only \$10.95 each

Green, Maroon, Black, Red

GI Anglehead Flashlights — \$6.95

OD, Black

Write or call for complete catalog of Military Clothing, Camping and Hunting Gear.
All orders are prepaid. Please add \$3.85 per order for shipping and handling. (Canada please add \$7.70
NYC residents add 8 1/4% tax. NYS residents add 6 1/4% tax.
Orders may be charged to VISA or MasterCard

Dept. SF

Anne and her family relocated to Washington, and kept the pressure on various government agencies so that they would not forget the plight of her husband. Eventually, letters from Muse and his daughter Kimberly reached President Bush, who took a personal interest in the case.

Since Muse had played a key role in rallying the opposition to Noriega using, at least for part of the time, U.S.-supplied transmitters, it was deemed that the United States had a responsibility to secure his release, especially as the planning for the American invasion went into high gear. The elite U.S. Delta Force was assigned the task of getting him out once the shooting started.

"This Is It."

When Muse finally fell asleep on 19 December, he was wearing shorts and a T-shirt. His jeans, polo shirt and sneakers were laid out at the end of his cot so that he could pull them on quickly in the event something happened.

At 1245 hours he was jarred from his fitful sleep by a long, sustained burst of gunfire. Muse jumped from his bed, grabbed his clothes, snatched the brace from beneath his cot, and hit the deck. He crawled into his bathroom and pulled on his jeans and shoes. He peered down the hall through his cell door. The prison was deathly still, so still, says Muse, that "you could have heard a pin drop."

Moments later he heard someone running up the stairs and down the corridor. "Oh, shit," he thought to himself. "This is it."

To be continued next month.

Neil Livingstone is an author, lecturer and consultant on terrorism and security topics. He is an adjunct professor at a number of institutions, including Georgetown University. His most recent book is *Inside the PLO (Morrow, 1990)*, which he co-authored with David Halevy.

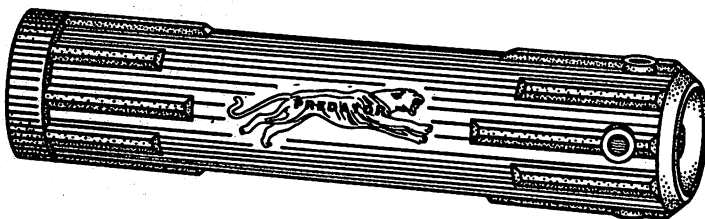

API SPECIAL S.O.F. 15th ANNIVERSARY SALE!!

PREDATOR SSP2 LASER SYSTEM

SALE \$199 + COUPON

CONSTRUCTION: Space-Age ABS/Nylon composite
WEIGHT: 2.6 OZ. (4" Length)
BATTERY: Eveready #523, Duracell PX21, etc.
DOT ADJUSTMENT: 4 WAY INFINITE POSI-LOC.

FOR THOSE WHO MUST HAVE THE BEST!!

- This original coupon
- must accompany order.
- S.O.F. ANNIVERSARY



API MARKETING, INC.

1600 MONROVIA AVE.
NEWPORT BEACH, CA. 92663
(714) 722-9087
FAX 650-8906

CRAIG NUNN

Continued from page 81

sight in some houses. Craig, in a hurry to have a few words with the jumpmaster, came striding down the street shortly thereafter. He had landed in some suburbanite's backyard, breaking up a barbecue in progress. "What did they say?" I laughed. "Nothing," he responded, grinning from ear to ear. But then what do you say when a 6-2, 190-pounder wearing military utilities topped off by a Kamikaze headband drops into your roses? Remembering back, I think he enjoyed that as much as the excited gleam in the eyes of all the first-timers that day.

When it came to mischief, Craig was world class. Fired once from an advertising

PRIVACY AND SECURITY

NEW VIDEO

"Telephone 'Taps' and 'Room Bugs,'

How They're Done, How To Defeat Them"

This video clearly demonstrates in great detail how easily wiretapping and room bugging can be done and what to do to protect your privacy. A leading expert in the field of countersurveillance and privacy protection walks you step by step through the process of how eavesdropping is done.

This video will give you the knowledge that normally would take years and several thousand dollars to learn from someone "in the business" if you could get them to reveal their tricks. This is truly forbidden knowledge that isn't available anywhere else.

- Shows in detail many of the devices that could be used to invade your privacy.
- Demonstrates many of the detection devices available.
- Honest answers about what's really out there.
- What to look for and where to check.

This exclusive video tells it all! This is information that many people would rather you didn't have. Privacy is your right. Don't let others invade your business or personal life, find out how you can protect yourself today.

"Telephone 'Taps' and 'Room Bugs,' How They're Done, How To Defeat Them" Available in VHS format only. Reg. \$99. **DIRECT \$49.95.** (Ship/Insur. \$4.)

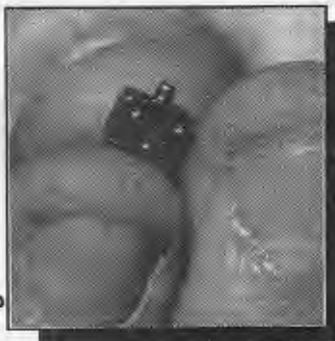

SAVE 50%

This could destroy your business...or your life!

BODY WIRE & BUG DETECTOR

Transfec silently vibrates when it detects a hidden RF transmitter. Can also be used to "sweep rooms." Small as a pack of cigarettes. Reg. \$795. **SALE \$695.** (Ship/Insur. \$10.)

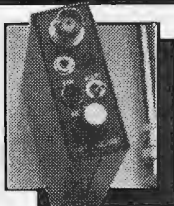

VOICE CHANGER

Fits over the handset of any telephone and electronically changes your voice to protect your identity. **\$298.** (Ship/Insur. \$5.)

TELEPHONE SCRAMBLER

The only way to protect your phone conversations is to scramble between the two parties. The SCRAMBLER has over 13,000 access codes, fits over handset, totally portable, uses 9 volt battery. Minimum of two required. Reg. \$395. **SALE \$299. each.** (Ship/Insur. \$10.) **Higher Level Scramblers from \$2,600. each.**

PHONE RECORDING SYSTEM

Totally silent, starts and stops special 8 hour long play recorder every time any telephone on the line is used. Records both sides of the conversation. (See warning.) **Long Play 8 Hour Recorder \$125.** (Ship/Insur. \$7.50) **Autostart \$59.95** (Ship/Insur. \$3.50) **SAVE — BOTH UNITS ONLY \$165.** (Ship/Insur. \$10.) **Optional Alligator Adaptor Clips for attaching anywhere on the line. \$10.** (Ship/Insur. \$3.50)

TELEPHONE EAR

This device enables you to listen to sounds in your home, office, warehouse, etc. from any telephone in the world. Just attach to telephone line, call number, enter ID code and listen. Reg. \$399. **SALE \$249.** (Ship/Insur. \$10.) (See warning.)

WORLD'S SMALLEST MICRO-CASSETTE RECORDER

Will fit inside a pack of cigarettes. The full featured RN-36 records for up to 90 minutes per side of a standard microcassette and comes with tie tack microphone, earphone, speaker/amplifier. Best microrecorder available. **RN-36 Reg. \$349. SALE \$299.** (Ship/Insur. \$7.50)

BUG DETECTOR DL-1000

DL-1000, hand held detector, goes with you anywhere to sniff out "bugs" in offices, homes, etc. L.E.D. bar graph indicator leads you right to the RF source. Audio verification circuit confirms the presence of a real "bug" which prevents false alarms. **\$695.** (Ship/Insur. \$10.)

PARABOLIC MICROPHONE

Long distance parabolic microphone with custom audio amplifier and graphic equalizer. 18" clear plexiglass dish. Range varies greatly with conditions. Fully portable. Best unit available for the money. **\$995.** (Ship/Insur. \$25.) (See warning.)

PROFESSIONAL COUNTERMEASURES SYSTEM

For the detection of "RF bugs," hidden microphones, carrier current, video cameras, laser listening devices, telephone eavesdropping modifications, and transmitters to 1.5 GHz. This is the most complete package that you can buy for under \$15,000. **CMS-3 Complete with Detailed Manual \$2,995.** (Ship/Insur. \$30.)

BRIEFCASE RECORDING SYSTEM

Remote activate the recorder from up to 30 feet away. Microphone and microcassette recorder totally hidden even when case is open. Top quality leather case. Reg. \$795. **SUPER SALE \$499.** (Ship/Insur. \$20.) (See warning.)

BODY WIRE TRANSMITTER

EP-151 transmits your voice or other sounds up to 1,000 feet away to the matching receiver (included) with this small (cigarette pack size) crystal controlled VHF transmitter. Reg. \$399. **SALE \$299.** Complete (Ship/Insur. \$10.) (See warning.)

MICRO CLOSED CIRCUIT TV CAMERA

Size of a cigarette pack. Includes cable and small 3" B&W monitor. Pin hole lens will see through a 1/4" hole. Camera can be hidden almost anywhere and has built in lens. Can be hooked up to a VCR. **Complete Set \$699.** (Ship/Insur. \$10.)

CONTACT MICROPHONE

EAR-200 contact microphone with built-in amplifier can clearly hear a baby cry through a solid wall. Recording jack provided. Ideal for search and rescue teams. Earphones and 9 volt battery included. Weighs only 4 oz. Reg. \$295. **Current Stock ONLY \$199.** (Ship/Insur. \$10.) (See warning.)

NEW LASER GUNSIGHT

State of the art diode laser enclosed in a rugged aluminum housing. Usable range over 200 yards at night. 1" dot at 100 yards. Only weighs 3.5 oz. WITH batteries, just 4.5" long. Weaver style rings included. Fits rifle, pistol, shotgun with different mounts. Batteries run 16 hours continuous. Pressure switch activated, only on when you need it. Reg. \$399. **SALE \$299.** (Ship/Insur. \$10.) **HELIUM NEON TUBE LASER GUNSIGHT** The FA-6 is the world's smallest true helium neon tube laser gunsight. More powerful than the diode laser. 6" long, uses two 9 volt batteries, built in weaver rings, weighs 11 oz. Reg. \$399. **SUPER SALE ONLY \$275.** (Ship/Insur. \$10.)



WALKIE TALKIE

Model VHF-30 is a powerful and compact, 4 channel, 5 watt VHF crystal controlled radio. Only 6" tall. Range up to 7 miles line of sight. Built-in rechargeable batteries. High quality throughout. Comes with one channel installed, charger, and belt clip. **\$329. each.** (Ship/Insur. \$10. per pair) **Exclusive! VHF-30 with Optional Built-In Scrambler.** Keeps scanners, etc. from understanding what you say over the radio. **Installed \$595. each.** (Ship/Insur. \$15. per pair)

SHOTGUN MICROPHONE

This hand held directional microphone is coupled with an amplifier and headphones. Good quality. Range varies with conditions. Retail \$499. **OUR PRICE \$249.** (Ship/Insur. \$10.) (See warning.)

BULLETPROOF VESTS

Stops .357 magnum and 9mm pistol. High quality, made from 18 layers of Kevlar. Rated Class IIA. Protects front and back. These vests are comparable to others at over \$400. **Special Purchase Sale ONLY \$269.** Call now! (Ship/Insur. \$10.) **Optional Hardplate available — stops 9mm submachinegun. \$99.** (Ship/Insur. \$5.)

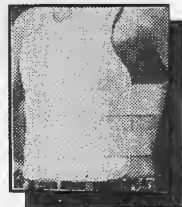

BINOCULARS & 110 CAMERA COMBINATION

Take a picture — color or B&W — of what you see. Uses standard 110 film. Small yet rugged. 7 power x 35mm. **\$695.** (Ship/Insur. \$10.)

LOW LEVEL LIGHT BINOCULARS

Clestron produces some of the best binoculars on the market. They have produced for us 7 power x 50 mm field of view binoculars with specially coated lenses that enhance what you can see at night. You will be amazed! This is not Starlight or Infrared Night Vision but has over three times light gathering capabilities of regular binoculars. Ideal for surveillance night or day. **\$195.** (Ship/Insur. \$7.50)

STUNLIGHT

Lightweight combination of a rechargeable flashlight and stungun. Carry 50,000 volts of protection with you day or night. Security that's always in your hand when you need it. **Complete with Charger SALE \$149.** (Ship/Insur. \$5.)

800 MHZ CELLULAR SCANNER

Desk top scanner with two antennae. Listen to police, fire, aircraft, etc. Includes VHF low, VHF high, UHF and aircraft bands. **Model 800 XLT \$399.** (Ship/Insur. \$15.)

NEW VIDEO CATALOG OF OUR PRODUCTS

See our entire line of real "James Bond" devices including all the items in this ad. **ONLY \$14.95** (Ship/Insur. \$3.) **Printed Catalog ONLY \$3.**

WARNING

NOT TO BE USED FOR SURREPTITIOUS INTERCEPTION OF ORAL COMMUNICATIONS. ALL EQUIPMENT IS SOLD SUBJECT TO PUBLIC LAW 90-351, TITLE III, 18 U.S.C., SECTION 2511, ALL LOCAL, STATE AND FEDERAL ORDINANCES, RULES, REGULATIONS, ETC. IT IS THE SOLE RESPONSIBILITY OF THE BUYER (NOT THE SELLER) TO CONSULT LEGAL COUNSEL FOR INTERPRETATION OF ANY LAWS APPLICABLE TO THE AREA OF INTENDED USE.

Executive Protection Products, Inc. — The Professionals
 1834 First Street ■ Suite S ■ Napa ■ California ■ 94559 ■ (707) 253-7142
 MasterCard ■ VISA ■ American Express ■ COD ■ 24 Hour Voice Mail Order Desk ■ Fax (707) 224-8702

FROM SPYE KNIFE CO

K.G.B. BALLISTIC KNIFE

**YOU CAN OWN ONE.
IN STOCK NOW!!**

American made of quality materials. Rugged construction. Matte black anodized aluminum. Tempered steel blade. Sold only without spring. Assembled knife may be illegal in some states.

Complete knife \$85.00
Minimum assembly required.
Spare blade assembly \$20.00 with knife order.
(\$25.00 if ordered separately.)
(SPRING KITS AVAILABLE TO AUTHORIZED PERSONNEL)

NEW BALLISTIC BATON

Baton
Penetrates
1/4" Plywood

The Ballistic Baton-A KNOCKOUT!! This is quality American made product. Delivers, non-lethal, powerful "punch" which will stop an attacker in his tracks.

P.D.S. baton (baton & Launcher).....\$100.00
Spare baton with P.D.S. baton order.....20.00
Spare baton ordered separately.....25.00

*Ballistic knife will accept baton!!
Grappling hook accessory for boating, hiking, climbing, available soon. Baton Launcher will not accept ballistic knife blade!*

Free Shipping in Continental U.S. Add \$3.50 handling. Certified check or money orders only. No CODs. No Phone Orders. Dealer Inquiries welcome. 407-466-2626.

Make Checks payable to:

Spye Knife Company

P.O. Box 902, Ft. Pierce, FL 34954

agency for adding an unusually long protruberance to a horse in a riding clothing ad sketch, Craig found a more appreciative audience at SOF.

The drawings, fake messages, memos, objects d'art and bizarre were cleverly conceived and like painkillers were time-released. A morning greeting on your computer terminal at 0800, something tucked on your appointment calender for mid-morning, something folded away in your paperwork on your return from lunch and one for the road hidden in your coat, briefcase or car. To this day we chuckle about the time our then-business manager whipped out a copy of SOF to show to someone sitting next to him on a plane only to discover that Craig had replaced all the interior pages with pages from a magazine so questionable you should be arrested for just owning it.

Craig was no respecter of persons; everyone was fair game to him. Looking down at a proof copy of Robert K. Brown's publisher's column he thought the mug shot lacked a fine mustache and thought bubble. It was for office consumption only so Craig was appalled when he learned it had inadvertently been copied and mailed with some other papers to an admiral in the Pentagon. After fessing up to me, we both had some nervous moments over the next few days waiting for the admiral's call to Brown. I can only assume the admiral thought it funny as well.

Unlike most practical jokers Craig could roll with the punch and laugh at himself when staff members struck back. His audacity, cleverness and perseverance helped make SOF's office a wonderful place to work. It's just not the same anymore without the periodic outraged scream of "CRAIG!" floating down the hall.

Craig was actually much more of a soldier than many at SOF even though as a Reservist he missed Vietnam. Because it was impossible for him to be out of the office for more than two weeks at a time his opportunities for action were limited at SOF also. But just before Rhodesia fell, Craig accompanied a combat patrol against terrorists that made contact. Seriously outnumbered, the terts launched one rifle grenade at the patrol and bomb-shelled. Craig learned about the minus side to carrying a shotgun on that patrol as his shot fell short. But as all combat veterans know, his shooting back when shot at made Craig a member of the club.

To me and just about everyone he ever met Craig was one of the club.

I'll always treasure my honorary Wolfen patch, Mekong Yacht Club T-Shirt, Iowa Hawkeyes sweatshirt and other mementos given to me by Craig over the last decade, but more than anything I'll treasure the memories.

Rest in peace my friend. The best we can ask for in this world is to have our enemies celebrate and friends regret our passing. Yours do. ☠

NOTICE TO CALIFORNIA RESIDENTS

Some firearms advertised in this magazine may or may not be lawful for sale in California.

Those specifically not allowed for sale in California are:

A. All of the following rifles:

1. Avtomat Kalashnikovs (AK) series
2. UZI and Gali
3. Beretta AR-70 (SC-70)
4. CETME C3
5. Colt AR-15 series and CAR-15 series
6. Daewoo K-1, K-2, Max 1 and Max 2
7. Fabrique Nationale FN/FAL, FN/LAR and FNC
8. FAMAS MAS223
9. Heckler & Koch HK-91, H-93, HK-94 and PSG-1
10. MAC 10 and MAC 11
11. SKS with detachable magazine
12. SIG AMT, SIG 500 Series, and SIG PE-57
13. Springfield Armory BM59 and SAR-48
14. Sterling MK-6 and SAR
15. Steyr AUG
16. Valmet M62, M71S and M78
17. ArmaLite AR-180 Carbine
18. Bushmaster Assault Rifle (armgun)

19. Calico M-900 Assault Carbine

20. Mandall THE-TAC-1 Carbine
 21. Plainfield Machine Company Carbine
 22. PJK M-68 Carbine
 23. Weaver Arm Nighthawk
- B. All of the following pistols:
1. UZI
 2. Encom MP-9 and MP-45
 3. MAC 10 and MAC 11
 4. INTRATEC TEC-9
 5. Mitchell Arms Spectre Auto
 6. Sterling MK-7
 7. Calico M-900

C. All of the following shotguns:

1. Franchi SPAS 12 and LAW 12
2. Gilbert Equipment Company Striker 12 and SWD Street Sweeper
3. Encom CM-55

SOLDIER OF FORTUNE MAGAZINE

Jog, Work, Relax in SOF Sweats for Men



To hell with candy-colored designer warm-up suits! These honest sweats for real men give you what you want — high-quality warmth and protection in a no-nonsense color. Practical, durable clothing at a very good price!
Sizes S,M,L,XL

#1030 Sweatshirt, Black \$14.95
#1029 Sweatpants, Black \$15.95
#1036 Hooded Sweatshirt \$22.95
(Add \$3 P&H 1st item, \$1 each additional item.)
Call Toll-Free to Order — Visa, MC, C.O.D.
1-800-323-1776, Operator 131
Or Send Check or Money Order to:

SOF Exchange, Dept. 10-90
P.O. Box 687
Boulder, CO 80306

ANOTHER PEACETIME CASUALTY.

You don't have to be in the service to appreciate a good boot. But it helps.

We don't cement our EVA midsoles and Vibram® outsoles to the uppers, we stitch them. That way they can be resoled some day.

Thirty-mile forced marches, maneuvers in Alaska—it's familiar territory to a company that began outfitting loggers and trappers 54 years ago.

So we weren't surprised to hear a while back that some lieutenants from Fort Lewis were buying our boots and dyeing them.

"Why don't you make these in black?" they asked.

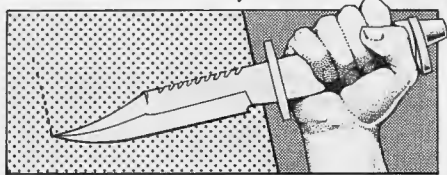

Our 1000 denier Cordura® nylon insets have ten times the tensile strength of leather. And less than half the weight.

That sounded like an order to us, so we had our full-grain leather tanned black inside and out (that way it doesn't show white at the seams), cut it two inches taller at the top (so you can tuck your pants in), and added D-rings (for dress wear).



One firefighter said our Thinsulate® insulation was so good he couldn't tell his boots were on fire.

And now we're even taking orders from raw recruits. All over the country.

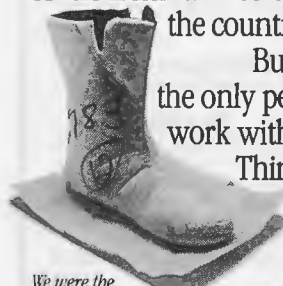

We were the ones who invented the waterproof Gore-Tex™ liner seven years ago.

we now offer the full range of service footwear, including the only walking shoes

But you're not the only people who work with your feet. Think of the police. Firefighters. Letter carriers. We did, and



with components proportioned to size. And with heel wedges designed to disperse shock.

No matter what you do, call Danner for the boots and shoes

to do it in. Because chances are it's not your feet that are killing you. Chances are it's the other way around.

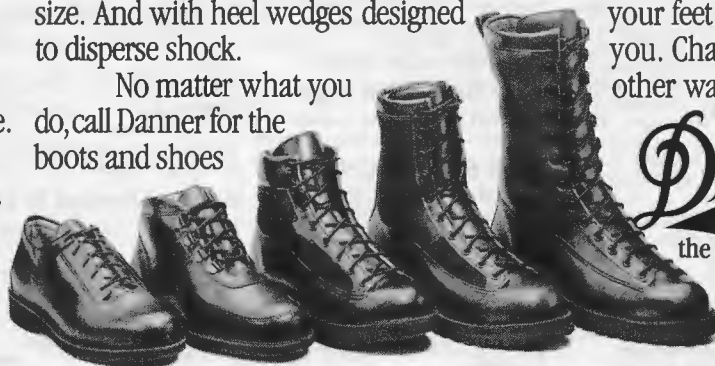

Danner

Call us for a free brochure or the name of your nearest Danner dealer.
1-800-345-0430.

OUTLAW JUMPERS

Continued from page 59

looking at a point above the horizon. If you looked down as you launched you would tumble forward and might open facing the tower.

There is nothing so lonesome as being right on the edge of a sheer drop just before a BASE jump. My companion, due to jump immediately after me, had already attached his static line and was just waiting for me to clear the launch point. I looked around at him. Standing safely on the platform he seemed relaxed and offered words of comfort, "Well, go on, jump." Had I been able to release my grip on the safety bar without falling I think I would have throttled him!

Having placed myself in this position and run out of excuses it was time to jump. Once again a feeling of total calm came over me. This sensation was such a common experience among BASE jumpers it became known as "The Moment." It was the point at which mentally you had totally committed yourself and all that remained was to physically make the jump.

With a sharp intake of breath I braced, and dived from the platform. The canopy opened fast and clean. I released the steering toggles and made a straight glide towards the luminescent panels. The approach was fast in the still air lower down and I needed to flare the canopy to make a

stand-up landing possible. Wow! A wave of adrenaline washed over me as I turned to see my companion leaping clear of the tower. Another good clean opening, straight glide, flare and stand-up landing close by.

Scooping up our parachutes we raced to link up and embrace each other out of sheer joy. The support team came bounding across with broad grins and urgent advice to head for the escape car. Two minutes later we were speeding away from the scene. Undetected, clean getaway. A few miles away we stopped, still within sight of the tower, and popped a bottle of champagne. I had qualified for BASE.

Peter Douglas is a former Royal Marine who also wrote this month's "No Honor Among Mercs" (see page 60).

NO HONOR

Continued from page 67

men to track Richards down, Brunswijk was content to let them escape through the jungle, back to French Guiana. Although angry that Richards had escaped, he was also relieved that the decision about what to do with him was now out of his hands.

Two hours later, the remaining mercenaries were standing outside a brick airport building, talking to Brunswijk. Suddenly,

Richards and his three cohorts burst out of the jungle on the other side of the airstrip and dashed straight at Brunswijk, firing as they charged. Wild shots cracked past, only inches from Brunswijk and the three mercenaries. Spouts of red dust exploded on the wall behind them.

Finny, Alan and Bill threw Brunswijk and themselves to the ground, bringing their FN FALs up on aim as they did so. Every Jungle Commando in the area opened fire on Richards and his men. Richards stopped short and staggered backwards, reeling from the impact of several hits. Then he fell, all the fight shot out of him. This sudden reversal of fortune panicked the other charging mercenaries, who instantly lost heart. Throwing their weapons away, they put their hands up, and begged the Jungle Commandos to stop shooting. Amazingly, they did!

The Jungle Commandos advanced on Richards — now bleeding in the dirt — and the surrendering mercenaries. Richards had been shot all over; he was more dead than alive, although still mumbling incoherently. One of the Jungle Commandos put his FN FAL barrel to Richards' head and

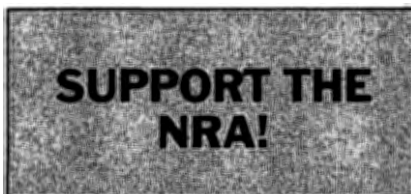

GREENE

MILITARY DISTRIBUTORS

Finest Quality & Lowest Prices Available in Military & Hunting Apparel & Accessories

GENUINE GOV'T. ISSUE M-65 FIELD JACKET

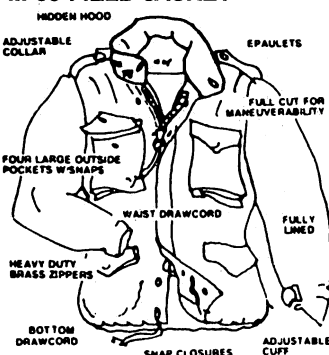

Brand new; first quality; genuine military issue; water repellent; 50% nylon / 50% cotton sateen; fully lined. Manufactured under strict quality standards by a prime government contractor in the U.S. Woodland Camouflage and Olive Drab. Sizes XS, S, M, L, XL. Longs in M, L and XL (add \$5.00). Also available in Tiger Stripe Camo, Black, Navy, Winter White, Khaki and Day Dessert. \$48.95 Olive Drab and our three new additions—Trebarck® Camo, Skyline® Camo and Treeline® Camo add \$2.00. XXL add \$6.00; XXXL add \$8.00.

M-65 Cold Weather Liner
(button-in) in Olive Drab or Black \$16.95

Kid's Jacket (identical to adult's) in Woodland Camouflage and Olive Drab Sizes 4-6, 8-10, 12-14, 16-18 Made in U.S.A. \$39.95

WRITE OR CALL FOR OUR NEW FREE CATALOG

Battle Dress Uniform (BDU) Brand New • Latest Issue • First Quality

Pants feature: Double fabric seat and knees; 6 pockets (2 slash front pockets, 2 rear pockets with button flaps, 2 large bellows pockets on thighs); adjustable waist tab; button fly; drawstring cuffs.

Shirts feature: Double fabric elbows; 4 pockets (bellows style)

Woodland Camouflage

(1) 50/50 NyCo \$26.95 ea.

(2) 100% Cotton Rip Stop \$29.95 ea.

Day Desert Camouflage

50/50 Nylon Cotton \$28.95 ea.

S.W.A.T. Black

(1) 100% Cotton Rip Stop \$29.95 ea.

(2) 50/50 Poly/Cotton \$29.95 ea.

[Sizes: XS-XL (regular & long lengths) XXL \$34.95 XXXL \$36.95]

Olive Drab (OD) Green

100% Cotton Rip Stop \$28.95 ea.

Tiger Stripe Camouflage

100% Cotton Rip Stop \$29.95 ea.

Khaki

100% Cotton Rip Stop \$29.95 ea.

Solid White

100% Cotton Rip Stop \$29.95 ea.

Solid Grey

100% Cotton Rip Stop \$29.95 ea.

Urban Camouflage

50/50 Poly/Cotton \$29.95 ea.

Subdued Urban Camouflage

(no white) 50/50 Poly/Cotton \$29.95 ea.

Authentic Trebarck® Camouflage

Pants or Shirt \$29.95 ea.

Pullover Parka



Woodland Camo (50% nylon / 50% cotton sateen) Tiger Stripe, Black, Navy, Winter White, Khaki, Day Desert \$29.95
Olive Drab, Trebarck®, Skyline® and Treeline® camo \$31.95

MA-1 Flight Jacket

Intermediate weight, reversible to orange.

Sage Green, Black & Navy \$48.95

S, M, L, XL, GOV'T ISSUE \$48.95

Long lengths and XXL add \$5.00.

L2-B Reversible Flight Jacket

Same as MA-1 except light weight & w/eps. Sage & Navy \$46.95

N2-B Extreme Cold Weather Flight Jacket

Heavy weight. Designed for temperatures of -10° to 32°F. Sage Green S, M, L, XL

Genuine Gov't Issue \$86.95

NEW USAF A-2 Flight Jacket

Brown goatskin, sizes 34-46

Genuine Gov't Issue \$219.95

Long lengths and sizes 48 & up add 10%

NEW Gen. G.I. Sleeping Bags

Intermediate cold weather (6' 6")

to 0°F. Olive Drab or Tiger Stripe \$89.95

Extreme cold weather (-40°F) Olive Drab

Genuine Gov't Issue \$219.95

Acrylic Trimmed M-65 Hood Gen. Gov't. issue, wool lined, O.D. \$19.95

Wolf fur trim \$24.95

G.I. Jungle Fatigues (O.D.)

Slant Pocket, 100% cotton, rip-stop ea. pc. \$29.95

Wooly Pully® Sweater

Made in England, 100% virgin wool. \$48.95

Crew neck: Woodland Camo, Black, Olive Drab, Sand. V-neck w/eps: USAF Blue, US Army Black

w/breast patch add \$2.00. sizes 48 & up add \$4.00

Gov't. 5-Button Sweater

Army Brown, 100% wool Gov't Issue \$26.95

Black acrylic \$24.95

Combat Boot New Gov't. issue, water resistant, speed-lacing \$42.95

CWU-45/P Aviator's Jacket

Winter weight. Identical to the Nomex (Fire Resistant) Jacket except in nylon. Sage Green or Black. S, M, L, XL \$68.95

Mail proper amount plus \$4.95 (double for Canada) (TN residents add 7.75% sales tax) for shipping and handling to:

GREENE MILITARY DISTRIBUTORS, INC.

7215 Kingeton Pike, Dept. SF, Knoxville, Tennessee 37919

ORDER TOLL FREE 1-800-521-7977

in TN (615) 588-5945

Satisfaction Guaranteed or Your Money Back



GUARDIAN Security Products

TOLL FREE! 1-800-527-4434



RECORD YOUR PHONE CONVERSATIONS

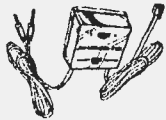

Tape phone calls automatically. Simply connect our "Phone Recorder" to your cassette recorder and record both sides of the conversation whenever the receiver is lifted.

TT5.....\$22.00

POOR MAN'S PERIMETER ALARM

These neat pull string alarms produce a loud 85 decibel bang and will wake even the soundest of sleepers. Rig them up anywhere. Sold in paks of 72.

SM59.....\$3.95

120,000 VOLTS!

This awesome stun device will discourage most attackers up to 20 feet away! The high-intensity discharge you have to see and hear to believe. The most powerful stun gun available!

OM10.....\$119.95

WIRETAP DETECTOR



Notifies you of unauthorized intrusion onto your phone line. LED and meter make it easy to keep your phone conversations private. Best value on market!

ST1.....\$79.95

SEE WHO'S BEHIND

Surveillance sunglasses enable you to see behind. Special lenses also provide UV ray protection.

SM5G.....\$9.95



NOVA ELECTRONIC RESTRAINTS

The most popular stun guns in the world! Used by over 600 law enforcement agencies. 50,000 volts of power. Made in the USA with a two year warranty. Two models: XR5000 includes NiCad battery and charger. Spirit includes 5 year lithium battery. State-of-the-art in stun guns.

NV1.....XR5000.....\$89.95

NV2.....Spirit.....\$137.95



NEW ITEMS

TELEPHONE PRIVACY

Privacy Device Lets you know if your phone conversations are being overheard on an extension. LED indicator informs you of eavesdropping.

TT2.....\$29.95



BUG DETECTOR

Find Hidden RF transmitters in your home, office, car or attached to your telephone line. Warns you of bugs within the frequency range of 1 MHz to 1000 MHz. Easy to use. No special training required to find even most sophisticated bugs.

CAP1.....\$119.95



DON'T BE A VICTIM!

60,000 volts of power in our most economical stun device. You can instantly scramble any assailant's nervous system for immediate but temporary paralysis. Effective even through many layers of clothing.

BS1.....\$39.95



BODYGUARD DETERRENT SPRAY

A completely different kind of deterrent spray. Acts as an inflammatory agent, rather than an irritant like tear gasses. BodyGuard will control drunks, psychotics, attack dogs and drug abusers. 100% success rate in real life incidents. Contains 2% oleoresin capsicum. 2 models. With or without holster. Don't leave home without BodyGuard

BSD1.....Plain.....\$10.95

BSD2.....w Holster.....\$15.95



LONGRANGE LISTENING

Parabolic system increases sound by up to 30 db. Unbelievable range of sound pickup. Comes complete with headphones, microphone system, parabolic dish and cabling.

SCI1.....\$139.95



KUBOTAN KEYCHAIN

Perfect defensive weapon. Can be taken anywhere.

MO2.....\$5.95



LADIES SPECIAL

60,000 volts! Specially designed to fit ladies hand. Has safety locking micro switch to prevent accidental discharge in the pocket or purse. Only 5" in height.

BS7.....\$49.95



20 FOOT RANGE!

The latest development in nonlethal sprays. No other spray deterrent even comes close to the range and power of "BodyGard-II". Exclusive Halon valve assures a blast to stop even the toughest and meanest attacker.

BG3.....\$29.95

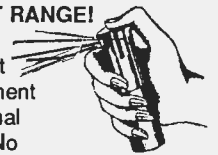

MINI WIRELESS TRANSMITTER

This small little black box can transmit picked up sounds back to a standard FM radio up to 100 yards away. Ideal for learning to use countermeasures equipment, to detect bugs or to monitor remote buildings, etc. Uses watch or camera battery.

ET2.....\$79.95



HEAR THROUGH WALLS

Pick up and magnify sound from solid objects. Our special sound detector system can be used on glass, wood, plaster, brick or even concrete as thick as 12 inches. Set comes with headphones or you can attach it directly to tape recorder.

DT13.....\$259.95



SLAPPER SAP

CA16.....\$19.95

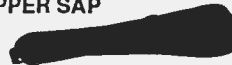

PRO HANDCUFFS

Professional quality double lock cuffs are nickel plated for years of service

SM64.....\$16.95

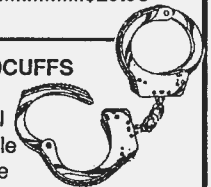

MC/VISA, AMEX & COD ORDERS CALL TOLL FREE:

FAX: (602) 870-0735

1-800-527-4434

Mail-in Orders send check or money order to:

GUARDIAN SECURITY PRODUCTS

8350 N. 7th St. • Phoenix, AZ 85020

SF10

please ship _____

add \$3.50 S & H TOTAL _____

NAME _____

ADDRESS _____

CITY _____ STATE _____ ZIP _____

TOLL FREE: 1-800-527-4434
Catalog \$2.00 - Free with Order

pulled the trigger. For Richards, the price of deceit and treachery was death. For his companions, standing with their arms stiffly above their heads and a look of stunned horror on their faces, the future looked bleak: The Jungle Commandos were demanding that they be shot.

Brunswijk ordered his men not to shoot — at least not yet. A serious dilemma now presented itself to Finny, Alan and Bill. Should they speak up for their former companions-in-arms, or allow proceedings to take their seemingly inevitable course? They felt little more than disgust for these men, after all.

Not only had they treacherously followed Richards in his attempt to kill Brunswijk (and indeed them), but details of the attack on Kraka had since emerged. Apparently, they had cold-bloodedly executed some young army conscripts after they had given up their arms and surrendered.

There seemed to be no redeeming factors in their defense and, with emotions running high among the Jungle Commandos right now, their future was looking bleaker by the second.

Brunswijk asked the remaining Brit mercenaries for their opinion on the situation. This was tricky. Finny, Alan and Bill could not afford to antagonize Brunswijk by appearing to be over-sympathetic to their former associates. At the same time, they felt morally obliged to do what they could to prevent their execution in cold

blood.

Choosing their words with care, they said that while they wholeheartedly condemned the men for their actions, they had to advise that their lives be spared. They suggested that in all probability they were not aware that Richards had been plotting to kill Brunswijk, that they had just blindly and stupidly followed his lead and trusted his judgement. Perhaps they just finally had to fight their way out without understanding, or questioning, why Richards was advocating such action. There was also the inevitable bad press that would follow in the wake of executions, with the propaganda value the Bouterse government would make of it.

Brunswijk listened carefully to the arguments they put to him. He realized that had it not been for their quick reactions in defending him, he would probably have been gunned down by Richards. His final decision was to expel his would-be assassins to French Guiana. This clemency dismayed many of the Jungle Commandos, but Brunswijk was obeyed.

Liam, Sven and Joseph had a haggard, beaten look to them when they were dragged off to a truck and bundled in. It was hard for them to believe that they were not being driven to their deaths. In fact, they were escorted to the Marownije River and dispatched back to French Guiana. A stern warning came with the send-off: if they ever attempted to return, they would be shot on sight. Their lives in Suriname

were forfeit.

Richards' body was handed over to the police, who took it to Paramaribo, the capital. By this action, Brunswijk hoped to prove that the attack on the army base at Kraka was not conducted by his order, and that the man responsible had been dealt with. Film of Richards' dead body was subsequently televised in Suriname with condemnation of the fact that the Jungle Commando employed foreign mercenaries (conveniently overlooking the Surinamese government's use of Libyan soldiers). At any rate, the truce was saved.

No such ceasefire existed with the Tacujana Indians, however, and word came that they had sent "a large force" to attack Moengo. Finny, Alan and Bill were instructed to "plan something." They welcomed the opportunity to demonstrate their professional expertise, and at the same time, cement their relationship with Brunswijk. This was the task for which they had been preparing ever since their arrival.

After selecting nine Jungle Commandos to accompany them, they filled their backpacks with the claymores that had already been assembled. Tooling up with plenty of ammunition, and ensuring that each of them had his medical kit, they set off under cover of darkness to make contact with the approaching Tacujana Indian force.

In the early hours, several miles out of Moengo, they reached a crossroads which looked suitable for an ambush. Tactical awareness being fairly low among the

NIGHT VISION

AFFORDABLE SEE-IN-THE-DARK TECHNOLOGY

WHEN NOTHING BUT THE BEST WILL DO
AN/PVS-4 STARLIGHT NIGHT VISION SYSTEM



CURRENT STATE OF THE ART AN/PVS-4
2ND GENERATION NIGHT VISION SYSTEM.

This is the finest unit available today. We are the National Distributor for O.E.C., the current military contractor for 15,000 units of the AN/PVS-4. We can offer you the same unit the military receives.

New—With Excellent Reconditioned Intensifier Tube
\$2,850.00 Add \$15.00 for Reg. UPS—\$30.00 for Next Day Air

NEW—With New Intensifier Tube
\$3,895.00 Add \$15.00 for Reg. UPS—\$30.00 for Next Day Air

We use genuine MIL-SPEC A.R.M.S. mounting systems.

We offer a full line of top quality products plus the unsurpassed service knowledge of night vision experts. We service and stand behind every product we sell. For more information on additional night vision systems, goggles, and viewers write or call:

EXCALIBUR ENTERPRISES

P.O. Box 266 (215) 391-9101
Emmaus, PA 18049 FAX (215) 391-9220

SEND \$4.00 FOR OUR COMPLETE CATALOG

STARLIGHT WEAPON SIGHT/VIEWER
AN/PVS-2B

HURRY!
ACT NOW & SAVE OVER
\$1,000.00

WE'RE
ALMOST OUT!
ONLY
\$1,695.00

First the Good News . . . We're offering a fantastic price on Night Vision Equipment! The AN/PVS-2B, with its high performance nitrogen filled lens and high gain 25mm intensifier tube, is the best performing first generation scope issued in quantity to the U.S. Military. This versatile unit, with optional adaptors, can be weapon mounted or used for low light level photography.

- First Generation Reconditioned Intensifier
- 4 X Magnification
- Range 400 to 600 yards for weapon aiming. Up to ½ mile for surveillance, depending on light level and terrain.

This unit previously sold for \$2,750.00. Due to an incredible buy on these reconditioned units, we are offering them at **\$1,695.00**, a savings of over \$1,000.00!

Now the Bad News . . . Quantities are limited. These "like new" Starlight scopes are selling fast at this low price, so order now to take advantage of this exceptional opportunity!

Shipped with: Tripod/pistol grip adaptor, daylight lens cover, operating manual and batteries. Add \$100.00 for AR15/M16 mounting system. Other mounting systems are available, prices on request. Add \$15.00 for regular UPS shipping, \$30.00 for Next Day Air. 6 MONTH LIMITED WARRANTY.

**NOT AVAILABLE FOR EXPORT
NO F.F.L. REQUIRED**



Excalibur gives you the COVERT EDGE at affordable prices!



SOF EXCHANGE BOOKSHELF

IN CANADA MILARMA CO. LTD. 10769-99 ST. EDMONTON, ALBERTA T5H 4H6
PHONE 403-424-5282 FAX 403-424-5306

Vietnam — Our Generation's War From the first Marines to the fall of Saigon, *NAM* brings you the triumph and defeat of America's longest war. With eyewitness accounts, unrivaled photos and graphics, weapons and tactics profiles, and searching analyses of the war's development from both sides of the DMZ, *NAM* is the finest documentary of the war you'll ever read.

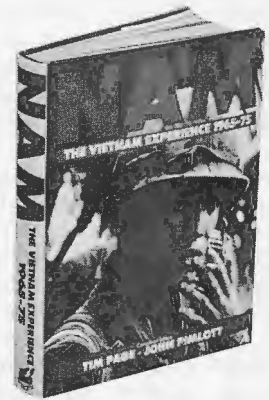

#8040 — Hardcover \$39.95



#8036 - **The Dictionary of Espionage** by Henry S.A. Beckett. A comprehensive guide to spook speak. **\$17.95**



#8037 - **The Road to Kalamata** by Mike Hoare. A straight forward account of Hoare's 4-Commando actions while in the service of Moise Tshombe's newly created Independent State of Katanga. Hardcover. **\$17.95**



#8038 - **Portugals Guerrilla War** by A.J. Venter. This is a book about a ten-year war in Portuguese Guinea. This war is not just another African military conflict. On its outcome hinges the destiny of all Africa. Hardcover. **\$9.95**



#8006 - **Knife Self-Defense for Combat** by Michael D. Echanis. First in a series dealing with hand-to-hand combat as taught to the Special Warfare Branches of the United States Military. **\$9.95**



The Elite: Story of the Rhodesian SAS by Barbara Cole. The exploits of the famed Rhodesian Special Air Service from its inception to its disbandment. #8019 - **\$19.95** #8023 - Special leather collectors' edition **\$100.00**



#8026 - **The Elite: A Pictorial** This 168-page hardcover edition covers the exploits of the famed Rhodesian Special Air Service, from its inception to disbandment, in front-line, you-are-there photography. **\$21.95**



#8012 - **An Illustrated Guide to Modern Elite Forces** by Max Walmer. A concise guide to today's elite forces of the world. Over 34 units are covered from 17 different countries. 160 pages filled with b&w and color photos. **\$11.95**



#8021 - **The Soldier of Fortune.** Adapted from *Soldier of Fortune* Magazine. A book filled with photos and stories of the elite men and elite units. **Specially priced at \$7.95**



#8025 - **Mercenary Commander** Here's the inside story of mercenary work — Africa style. From the 1960s Belgian Congo to the 1980s Seychelles, Colonel Jerry Puren fights the wars only the toughest can survive. 384 pages with excellent photographs. Hardcover. **\$29.95**

#7033 — **SOF Magazine Binder** Holds 12 issues. \$10.95

#8020 — **Shoot a Handgun** by Dave Arnold. A complete manual of simplified handgun instructions. **\$9.95**

#8022 — **The Best of Survive** A handy guide comprising the finest how-to articles from Omega's Survive Magazine. **\$2.95**

#8039 — **Secrets of Modern Knife Fighting** A comprehensive guide on knife fighting. **\$9.95**

| BOOK # | QUANTITY | PRICE |
|-----------------------------|----------|-------|
| | | |
| | | |
| | | |
| SUB TOTAL | | |
| Postage & Handling | | |
| 3.7% Sales Tax (Colo. res.) | | |
| TOTAL | | |

Please include \$3.00 for the first item ordered — include \$1.00 for each additional item for postage and handling. Overseas orders add 40%. Please allow 4-6 weeks for delivery.

SOF EXCHANGE BOOKSHELF

Mail to: SOF Exchange ST 10/90, P.O. Box 687, Boulder, CO 80306

We accept telephone orders on MasterCard, VISA or C.O.D. — call toll-free — 1-800-323-1776, Operator 131. **NEW! FAX YOUR ORDER 303-444-5617!**

PAYMENT: VISA/MASTERCARD CHECK ENCLOSED COD

CARD # _____

EXPIRATION DATE _____

NAME _____

ADDRESS _____

CITY _____ STATE _____ ZIP _____

For customer service calls, dial (303) 449-3750 — between 9:00 a.m. and 4:00 p.m. mountain time.

combat forces of Suriname, the Tacujanas could, with reasonable confidence, be expected to arrive by the most direct route available: straight down the middle of the road.

Dawn was already arriving as the men began to prepare the ambush. Bill was to man the 5.56mm Minimi LMG with three Jungle Commandos in a right flank cut-off group. Finny and Alan, with six more Jungle Commandos, formed the kill group. Finny was to be responsible for detonating the mines. Explosive charges were placed on the far side of the road which wouldn't do any harm unless someone were standing on one, in which case a leg or two might be blown off! They were meant to explode if anything went wrong. This would then frighten the ambushed party into running back for cover, toward the waiting claymores. Great care was needed to hide all traces of the explosive cord which, being meant for civilian (mining) use, was orange in color.

By 1000 hours, everything was ready. The plan was carefully explained to the Jungle Commandos once again. No one was to shoot until Finny detonated the mines. After this last briefing, the Jungle Commandos were placed in position whilst the mercenaries made one last check of the site before retreating into their own respective positions. There was nothing left to do but wait.

The sun climbed slowly higher, and with it, the temperature. Once directly above,

with the heat at its most intense, the sun seemed to hover perfectly static for several hours. The silent ambush party lay sweltering in sweat. Hidden in the shadows were swarms of mosquitos, which paid savage attention to the pale skin of the mercenaries, but left the darker-skinned Jungle Commandos unmolested.

Ants scurried about on urgent missions. Cicadas kept up their incessant, shrill barrage of noise. Long, cramped hours passed. Then, at 1600 hours, before anything could be seen, the ambush party heard people approaching. Gripping their weapons tightly, they peered through the foliage. The noise of a chatty, apparently relaxed group of men grew louder. Then they walked into sight, right where expected, straight down the middle of the road. Two staggered along under the load of 7.62mm MAGs, swathed in rattling belts of shiny link ammunition. The rest carried FN FALs. They were oblivious to any danger.

Finny eyed them, carefully timing the point at which to detonate the claymores to maximize the damage. Bill held them in his sights as they sauntered past his cut-off position and entered the killing ground. Alan subconsciously brushed his thumb against the safety catch of his FN FAL, just to reassure himself it was off. It was. He fought the urge to look toward Finny to check if he was ready. All three mercenaries silently prayed that none of the Jungle Commandos would open fire prematurely.

Everyone in the ambush party knew

there was going to be an explosion. They were tensed and ready for it, but when it came, they were momentarily stunned by the ferocity of the blast. Everything vanished in a sheet of flame and a roar of noise. Alan instinctively brought his weapon up on aim with the barrel pointing where the road should have been, but all he could see was smoke and dust. He squeezed the trigger and the weapon jerked back into his shoulder. Deafened by the blast, it was the only way he knew it was working.

Finny had shouldered his FN FAL and was blasting away at the point where the enemy was supposed to be. On either side of them now, the Jungle Commandos were also firing. The smoke and dust cleared enough to reveal the road. It was covered with bodies. With something visible to shoot at, the Jungle Commandos really let it rip. Spouts of earth leapt up where rounds hit the road. At such close range, though, it was hard to miss the tangled remnants of the Tacujana patrol, most of whom were laying perfectly still.

Bill eased the Minimi LMG into his shoulder as the tail end of the enemy patrol passed his position. Although firmly braced for the blast, he was also shocked by its ferocity. Instinctively, he began firing short bursts at the point where the patrol had been before the explosion. Three shadowy figures, running back toward the cut-off group, could just be made out through the continuing fog of smoke and dust. Bill followed one in the sights of the Minimi



.308 Win. COMING!
(7.62x51)

Take a Cheap Shot with ChinaSports Ammunition!

Quality NEW Ammo at the BEST Prices.

| | 9mm PARA | 7.62 x 39 | .223 |
|--|--|--|------|
| <p>Type: 9mmX19mm Luger Bullet: 124 gr. FMJ Copper Jkt. Lead Core Case: Brass Reloadable Primer: Boxer, Non-Corrosive Velocity: 1130 FPS Pkg: 50 rds. per box 2000 rds./case Mfg: NORINCO, current production</p> <p>Standard ball ammo for pistols and carbines firing 9mm ammo. High velocity FMJ ammo for small game hunting, defense, and target shooting. Manufactured with the utmost care to produce accuracy and dependability. This ammunition is priced right, packaged right and a profit maker.</p> | <p>Type: 7.62 X39mm Russian Bullet: 122 gr FMJ Copper Jkt. Lead Core Case: Steel Non-Reloadable Primer: Berdan, Non-Corrosive Velocity: 2850 FPS Pkg: 20 rds. per box 1200 rds./case Mfg: NORINCO, current production</p> <p>For the SKS and AK'S, this caliber is gaining popularity among U.S. shooters, small game hunters and collectors. The 7.62X39mm has ballistics similar to the 30/30 Winchester round and is excellent for small game. Now shooters can have inexpensive 7.62X39mm that is lead core and factory fresh, not surplus, from ChinaSports.</p> | <p>Type: .223 Remington Bullet: 55 gr. FMJ Copper Jkt. Lead Core Case: Brass Reloadable Primer: Boxer, Non-Corrosive Velocity: 3250 FPS Pkg: 20 rds. per box 1600 rds./case Mfg: NORINCO, current production</p> <p>Standard ball ammo for rifles firing 5.56mm or .223 Remington cartridges. Excellent for target shooters, small game and varmint hunters, police and military use. Designed to function with excellent accuracy in semi and full auto rifles as well as in bolt and single-shot rifles. Accurate, dependable, inexpensive ammunition for the .223 shooter.</p> | |

ChinaSports Inc.

P.O. Box 3250 Ontario, CA 91761
ALL CHINASPORTS PRODUCTS ARE SOLD THROUGH DISTRIBUTORS.
CONTACT YOUR LOCAL DEALER.

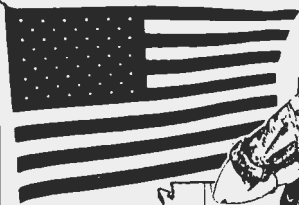

IMMEDIATE SHIPMENT

USAF Flight Jacket (Type MA-1)

- Nylon Shell is Waterproof, Windproof.
- Comfort Zone of 20° to 55°.
- Reversible to Survival Orange.
- 5 Large Pockets! (Inside, Outside, Sleeve)



Sizes: S, M, L, XL

Item #C-500

Choose Colors: Sage Green, Black or Navy Blue

Regular lengths \$59.95

Long lengths \$69.95

Military Berets

Jaunty, daring and classy — like the professional's who wear them! These are official regulation berets of 100% vat dyed wool and meeting all military specs. Made expressly for us by the prime military contractor.

Choose the official headgear of:

- Special Forces (green) Item #H-425
- Ranger (black) Item #H-435
- Airborne Paratroopers (maroon) Item #H-430
- Artillery/Guardian Angels (red) Item #H-440

Sizes: 6 7/8 to 7 3/4

(Not sure of your size? Tell us how many inches around your head where you wear your hat. We'll send the correct one) \$14.95.

Medic's Kit Bag

styled like the ones used in Vietnam. Nylon with 3 zippered compartments that fold open. New. Item #S-290... \$27.75.

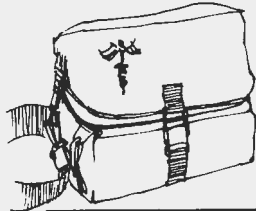

SATISFACTION GUARANTEED

CIA X-Ray Envelope Spray



Amazing fluid!! When sprayed onto any envelope, makes the paper transparent, thus permitting easy viewing of the contents. After about 30 seconds, the paper returns to normal — without a trace of discoloration, stain or odor!! (So no one can tell that the envelope has been "X-Rayed".) 6 fl. oz. can will treat dozens of envelopes. Made in USA.

Caution! Unauthorized access to US Mail is prohibited by law! Item #A-655 \$11.95/can.

Insignia

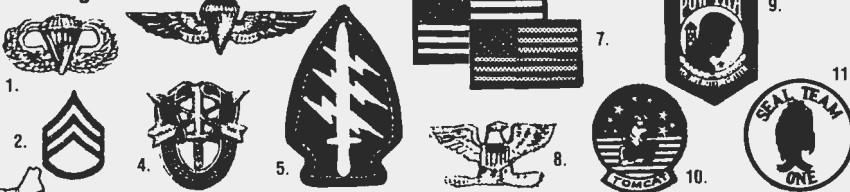

All insignia here are genuine and official! Our catalog features 25 color pages jammed with thousands more!

- | | |
|--|--|
| 1. AR-105 Paratrooper badge . . . \$3.50/ each. | 6. US-910FC US Flag patch, 2" X 3", full color . . . \$2.95/ each. |
| 2. AR-6658M Staff Sergeant rank . . . \$3.25/ pair. | 7. US-910SU US Flag patch, 2" X 3", subdued . . . \$2.95/ each. |
| 3. MC-400 USMC Recon Wing . . . \$8.95/ each. | 8. US-135 Full Bird Colonel rank . . . \$5.95/ pair. |
| 4. SF-105 Special Forces Crest . . . \$4.50/ each. | 9. VN-235 POW * MIA patch . . . \$3.95/ each. |
| 5. SF-275FC Special Forces Shoulder patch (full color) . . . \$3.00/ each. | 10. NA-605 Tomcat patch . . . \$5.95/ each. |
| | 11. NA-505 Seal Team One patch . . . \$4.95/ each. |

We're America's Army & Navy Store!!

For Over 65 Years The Kaufman Name Has Meant The Finest In Genuine Military Goods, Gear, Equipment and Insignia.

USAF Heavyweight Flight Jacket - Type N2B DESIGNED FOR TEMPERATURES OF -10° TO 32° F.

WE SHIP C.O.D. - C.O.D. FEE \$5.95

Watch Cap - 100% Wool

- Tight Ribbed Weave
- Roll Down to Cover Ears When Desired
- One Size Fits All
- Choose Color - Black or Olive Drab (OD) Green
- Item #H-355 \$6.00. each.



Polyester Fiberfill Lining - (Maximum Warmth Per Ounce)

Nylon Shell - (Waterproof & Windproof)

2 Outside Pockets
Knit Cuffs and Waist

Pile Line Hood - (drapes over shoulder when not needed)

Flap Under Zipper to Prevent Cold Spots

Zippered Sleeve Pocket with Pencil Holder

Choose: Black or Sage Green Outer Shell Color.

Sizes: S, M, L and XL. \$99.95. Item #C-550

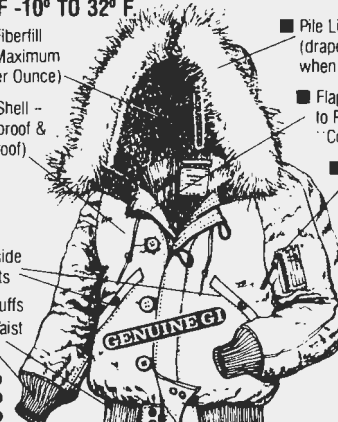

DOG TAGS

Regulation GI dog tags set of 2 tags and 2 chains (one 4", one 24"). Choose:

- Stainless Steel Set . . . Item #X-670 \$4.00.
- Black Commando Set . . . Item #X-675 . . . \$6.00.

Printing for Dog Tags — We'll print anything that fits! (6 lines, 15 spaces per line). Item #X-685 . . . only \$1.50 per tag (\$3.00/set). Sorry! No Dog Tag Printing Orders By Telephone.

Dog Tag Silencers — black, non-glare rubber bumpers for tag. Item #X-650 . . . \$1.95/pair.

Kaufman's Catalog — A \$3.00 Value.

(An award winner our catalog has been acclaimed by presidents and heads of state) Call or write for your free copy.



WHEN IN NEW YORK CITY VISIT OUR ORIGINAL STORE AT 319 W. 42ND ST., NEAR TIMES SQUARE. (PRICES MAY VARY AT NYC STORE)

Anglehead Flashlites — GENUINE GI

indestructible plastic; waterproof, non-glare, clips onto any belt. Uses 2 D cell batteries (not included) and comes complete with spare bulb and extra lenses. Choose: OD green or black. Item #R-165 . . . \$6.95.

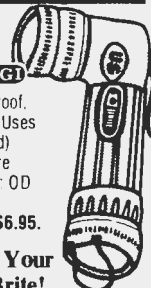

Krypton Bulbs Make Your Flashlight Twice As Bright!

High intensity bulbs for the GI or any standard flashlight. Installs in seconds. Item #R-725 . . . \$2.95/ pkg of 2 bulbs.

SHIPPING

Please include appropriate shipping costs from chart below with each order. Amounts shown include costs of postage, packaging, insurance and handling.

| | |
|---------------------------------------|---------|
| Orders up to \$10.00 | \$3.95 |
| Orders \$10.01 to \$20.00 | \$4.95 |
| Orders \$20.01 to \$50.00 | \$5.95 |
| Orders \$50.01 to \$70.00 | \$6.95 |
| Orders \$70.01 to \$100.00 | \$7.95 |
| Orders \$100.01 to \$200.00 | \$8.95 |
| Orders over \$200.01 | \$10.95 |

Canadian Orders—Send Double Amount Indicated.

ORDER TOLL FREE 1-800-545-0933 MONDAY-SATURDAY

KAUFMAN'S WEST INC. ARMY & NAVY GOODS (505) 293-2300 Dept. A-310 1660 Eubank NE Albuquerque, NM 87112 FAX: 505-275-1441

"Rangers Lead The Way"



U.S. Army Ranger By Peter Badcock
15 1/2" x 19 1/2" Color

Item # CP-26 Open Edition Poster.....\$9.95
Item # CP-26LE Limited Edition Print.....\$49.95
Item # CP-26LEF Limited Ed. Framed.....\$150.00



Ranger Tradition
14" x 24" Color

Item # CP-12 Open Edition Poster.....\$7.95
Item # CP-12LE Limited Edition Print.....\$29.95
Item # CP-12LEF Limited Ed. Framed.....\$99.95

RANGER TRAINING AND OPERATIONS

Now available for the first time, this is the official training manual of the U.S. Army's tough, legendary Rangers (FM21-50). Illustrated coverage of such topics as airmobile operations, ambush & roadblock operations, cliff assault operations, extended operations, antiguerrilla operations, general considerations of patrolling, Ranger history, and much, much more. 6 x 9, softcover, illus., 344 pgs.

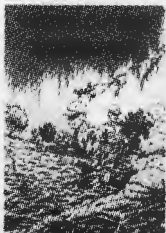

Item # C-137.....\$14.95

THE SOLDIER'S HANDBOOK

"Never fight anyone on equal terms". "Attack to destroy. Commit yourself violently and totally". This compendium details dirty fighting, detonators, igniters, explosives, fuses, munitions, railroad derailments, boobytraps, jelly-fuels (napalm), and rudimentary land and water safety, first aid and survival techniques and much more. 611 pages, 5 1/2" x 8", hardcover, heavily illustrated.



Item No. C-507.....\$100.00

Other books & manuals on the Rangers & Military Science

RANGER UNIT OPERATIONS

FM-7-85 (1987) **New Release**

Just released, this training manual is skilled in all basic light infantry skills and in ranger-unique skills. Chapters included are: Insertion, Extraction, Escape and evasion, strike operations, Special light Infantry operations, Deployment, Equipment, Combat support, History, and more! 216 pgs. \$1/2x11, illus.

Item # C-530\$19.95

RANGER Handbook

U.S. Army Infantry School

"Travel Light Freeze at Night"

Item # C-179 (soft cover 213 pgs., illus.).....\$8.00

Basic Parachuting Techniques & Training

Detailed methods used in training parachutists, jumpmaster training duties, jump procedures and safety requirements. 1984

Item # C-400 (soft cover 254 pgs., illus.).....\$14.95

Infantry Scouting, Patrolling and SNIPING

We thought this book was lost, but while cleaning out our warehouse we found the negatives. Originally written for the front line soldier in World War II this guide has taught soldiers in three wars the most important rule of combat... "Inflict the maximum amount of damage on the enemy with the least effort."

This book covers everything from moving as a patrol and platoon operations to camouflage for a lone sniper.

Item # C-680 (soft cover 200 pgs., illus.).....\$9.95

Survival Evasion & Escape

This is the book you've been looking for and is the only survival book you'll ever need. It has it all!

Item # C-680 (soft cover 431 pgs., illus.).....\$11.95

Rapelling

Great for mountaineers, police, military, cavers, scouts, firefighters & many others. Written for all skill levels.

Item # C-514 (Hard cover 264 pgs., illus.).....\$14.95

Add \$3 Shipping & Handling

CREDIT CARD ORDERS ONLY call our

Toll-Free Order Line

1-800-852-4445

For Questions Call 1-501-862-4984

Send Check or Money Order to:

DELTA PRESS
P.O. Box 1625 Dept-SOF4
El Dorado, AR. 71731

For a 68 page Color
Catalog Send \$2.00
FREE WITH ORDER



completed the allotted period of their contract, decided that it was time to go home. As it was nearly Christmas, however, they held out little hope of being able to book flights from French Guiana on short notice. Ronny Brunswijk and his Jungle Commandos came out to give the three a warm send-off.

After arriving in St. Laurent, the men prepared for the tedium of a long delay in a tacky Third-World hotel room. The gendarmery in French Guiana had other ideas, however. Acting on a tip, they arrested the mercenaries the moment they got into town. Now anticipating a long, confined wait of an entirely different kind, the three Brits were beginning to lose hope. Needless to say, when told they were being deported on the first flight out of French Guiana, they could hardly conceal their gratification. They'd be home for Christmas after all.

Peter Douglas, who served in Britain's Royal Marines before taking up the mantle of combat photojournalist, is a long-time foreign correspondent for SOF, and has filed numerous stories for us from the war zones of Afghanistan, Cambodia and Lebanon. In his spare time he jumps off of high places, and relates those experiences beginning on page 54 of this issue. ✕

DICKEY CHAPELLE

Continued from page 101

Fighters. Captured, she spent 52 days in prison, 38 of which were in solitary confinement. Her foolhardiness, she later realized, jeopardized every reporter covering the Hungarian Revolution, since she had compromised the neutrality that protects journalists.

In the years that followed, she buckled down and became a serious journalist, ultimately winning the 1962 Polk Award from the Overseas Press Club for "best reporting, any medium, requiring exceptional courage and enterprise abroad." But it was the U.S. Marine Corps' Combat Correspondents Association award that she was proudest of.

Dickey was always more interested in stories of individual courage and struggle than the often sordid politics of the conflicts that she covered. While she wrote graphically of the war in Vietnam, say her detractors, she was far too uncritical. If she was sometimes less than objective about the military, especially the Marines, says her former editor, Del Lipp, "It wasn't that she'd slant her stories, but that she was so involved with them." His wife, Shirley, echoes his assessment: "She must have been lonely. That's probably why she was so in love with the Marines."

While in Vietnam, Bernie Yoh introduced Dickey to the legendary counterinsurgency specialist, Major General Edward Lansdale. "He and Dickey became great



THE SEMIAUTOMATIC PISTOL IN POLICE SERVICE AND SELF-DEFENSE

BY MASSAD F AYOOB

First quantitative, documented look at ACTUAL POLICE EXPERIENCE with 9mm. and .45 police service autos. A no holds barred assessment of technical and tactical advantages of the popular combat auto pistols.

To order: Police Bookshelf, Dept. SF, PO Box 122, Concord, NH 03301 or call toll free 800-624-9049. ONLY \$9.95 plus \$2.00 for shipping and handling.

friends," recalls Yoh. "He admired her raw courage." When Lansdale learned of Dickey's death, he asked Bernie Yoh to go to Tan Son Nhut airbase to identify her body. He did so but, at the last minute, could not bring himself to unzip the body bag. He decided to remember her the way she had been, as "a valiant spirit, totally straight and honest. A gung ho American with a lust for life."

Dickey Chapelle was an adventurer. She believed that courage was "the control of fear," not the absence of fear. Her friend Pat Powell called her "a heroic warrior." She was that, too. But most of all, she was a woman who made few compromises. In the final analysis she chose the way she lived and, according to Bernie Yoh, if she could have chosen the way she died, it would "have been as it actually happened: in action, on her feet, with her Marines."

Neil C. Livingstone is an adjunct professor at Georgetown University and an authority on terrorism and national defense issues. Barbara Newman is a writer and former producer for ABC's 20/20. Her most recent book, The Covenant, will soon be made into a motion picture.

WHO DARES WINS

Continued from page 99

took their country out of dire peril while most residents and guests were just waking up in anticipation of a lazy Sunday morning.

Now that the revolution was a *fait accompli*, the senior army officers — who had given their tacit permission up to the point that they could maintain deniability if the venture should fail — were now ready to come out into the sunlight and admit that they had engineered the whole project. They quickly formed a military junta that moved to take over all the functions of government and return the country to "normal." After having cleaned house, the junta ultimately turned the reins of government back over to the democratic process.

During the coup for which he had so painstaking prepared, Maj. Breslin remained at the headquarters of the Quito CI detachment, coordinating and advising Capt. Usatagui. The communists and their terrorist minions had very nearly taken control when the "coup" quickly dismantled their organization by means of elimination, deportation, and/or prison. The leftist cadre members in the armed forces were, perhaps, the quickest to be identified and dealt with, because they had been thoroughly identified by the CIC group from the inception of their training. As a matter of fact, such individuals were written into the practical exercises that were employed at *Eloy Alfaro*. July da Cordova Reyes, a Cuban woman who was training URJE members in Guayquil was



TAC-LINE 550 CORD DISPENSER



PASSPORT T-SHIRTS



FRENCH CAMO FATIGUES

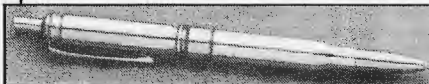

ACTION GEAR®

TAC-LINE® 550 CORD DISPENSER

Backpackers, Hunters, Military, Campers, Boaters, Climbers. At last, a unique, patented, prepacked dispenser puts 50 feet of indispensable 550 lb. test nylon 7-strand parachute cord at your fingertips. Tangle free, ready for use. Self-contained blade allows total one-hand operation. Knot tying chart shows how to use 550 Cord. Unique ambidextrous Cordura® nylon case attaches with dual ALICE clips. 8 oz.

Select: (01) Camo w/OD cord, (03) Black w/Black cord. TLCS(), Tac-Line with Case \$17.95

PASSPORT T-SHIRTS

If you've ever dreamed of traveling to the far corners of the world and stopping off at some of the more exotic — even slightly dangerous — watering holes, then we've got something for you. Made in USA. 100% cotton T-Shirts feature colorful fascinating designs that set your imagination soaring. M, L, XL.

BONE CELLAR — ZANZIBAR

Not for the squeamish. This underground saloon is located beneath an old fortress, interlaced with a maze of old tunnels and passageways. PST2 \$12.95

HUMPS — TANGIERS, MOROCCO

An institution since the 1940's. Noted for its legendary Gin Martinis and hot American jazz. PST4 \$12.95

FLYING TIGERS BURMA ROADHOUSE — RANGOON

Established in 1946 by several pilots from the A.V.G. (American Volunteer Group) who flew P-40's in WWII. PST9 \$12.95

MEKONG RIVER YACHT CLUB

No such club, but a very real place. PST1 \$12.95

RUSSIAN MIG-25

Mikoyan MIG-25 was Russia's response to the proposed U.S. B-70 bomber. Now, it's used as a Mach 2.8 high altitude photo-reconnaissance aircraft. PST24 \$12.95

FRENCH FOREIGN LEGION LEOPARD PARATROOP CAMO FATIGUES

The real McCoy! Created in 1952 for the French Para Battalion (BEP) battling in Indochina against Giap's forces. Genuine French Mil-Spec, 100% heavyweight cotton twill, dyed and printed to spec with impeccable attention to details. Sizes: (03)M, (04)L, (05)XL. FLC1(), Leopard Camo Coat \$80.00 FLC2(), Leopard Camo Trousers \$65.00

BRASS 7.62mm BULLET PEN

Handmade in W. Germany, P31707 \$19.95

ORDER TODAY TOLL-FREE

1-800-486-GEAR

VISA, MC, DISCOVER, AMEX

OR SEND CHECK OR M.O. TO:

60J



BRIGADE QUARTERMASTERS ACTION GEAR®

1025-60J Cobb International Blvd., Kennesaw, GA 30144-4300

ASK FOR YOUR FREE CATALOG!

CONGRATULATIONS TO SOF

on your
15th Anniversary

Hayward - Carson & Sober, p.c.
CERTIFIED PUBLIC ACCOUNTANTS

1800 38th Street, Suite 202, Boulder, Colorado 80301
Tel. (303) 440-4711

MORE SOF BACK ISSUES STILL THREE FOR FREE

Buy just six back issues of **SOLDIER OF FORTUNE MAGAZINE** for \$30 and we'll throw in 3 FREE ISSUES of your choice. OR buy nine back issues for \$45 and we'll send you THREE FREE ISSUES PLUS A BLACK SOF BINDER to keep all 12 in. That's a \$70 value for just \$45. And we'll still give you FREE DOMESTIC POSTAGE. (Foreign Orders: add \$3 1st issue, \$1 each additional.) Act Now! ALL issues are available except #2 & #3. Single issues \$5.00 each. Here's just a partial list:

- #1 Summer 1975: U.S. Vietnam Vets Attempt to Fight for Saigon; CIA Assassination of Trujillo; Col. Hoare & His Mercs in Angola.
- #4 Fall 1976: Vietnam Vet First American KIA in Angola; SOF Interviews CIC of Rhodesian Army; American Merc in Israel.
- #5 Winter 1977: Ralph Thorsen: Modern Bounty Hunter; Terror in Beirut — An Inside Look at the PLO; SOF Interviews Sir Robert Thompson
- #6 Spring 1977: SOF Recon: Action in South Africa; NRA Survival School; Paramedics in Guatemala.
- #7 September 1977: American Merc Destroys Cuban Espionage Ring; SAC Errors in VN Airwar Operation, Part 1; Rhodesia: "Castle Keep."
- #8 November 1977: South Africa Army Prepares for War; Israel Defense Force; SOF Interviews Mike Echanis; SAC Errors in VN, Part 2.
- #9 January 1978: Africa Is Burning; A Professional Soldier Evaluates CIA-Cuban Exile Ops; Freelancing in Cambodia.
- #10 March 1978: Bounty Hunting in Africa; Grey's Scouts; Rangers at Tet; Walther P-38K
- #11 May 1978: Mercs' Togo Assassination Try; Thai Army General Speaks Out; Cubans Torture U.S. POWs in Vietnam.
- #12 July 1978: French Foreign Legion Today, Part 1; H&K Assault Rifle; South African Commandos.
- #13 September 1978: French Foreign Legion, Part 2; SOF Interviews Cambodia's President-in-Exile; Mike Echanis: Hands vs. Guns.
- #14 November 1978: French Foreign Legion, Part 3; SWAT in Action; South African Strike in Angola.
- #15 January 1978: Jeff Cooper's "Gunsite"; SOF Interviews Gen. John K. Singlaub; SOF Rides with Rhodesia's Armed Corps.
- #16 February 1979: In Memoriam: Mike Echanis; French Foreign Legion Update; American Rides with Grey's Scouts.
- #17 March 1979: U.S. Navy Seals, Part 1; SOF Jumps With Confederate Airborne; Colorado NG Shows Regulars How.
- #18 April 1979: U.S. Navy SEALs, Part 2; Tommy Gun; Rhodesian Ranch Security; W.E. Fairbairn: Grandfather of SWAT.
- #19 May 1979: SMG vs. Pistol; AK-47 & Its Variations; Soviets Slam SOF.
- #20 June 1979: Death in the Night in Vietnam; Col. "Bull" Simons Engineers Iranian Jailbreak; OPFOR: The Friendly Enemy.
- #21 July 1979: BATF Gestapo; Combat Tracking Techniques; Fighting for Keeps; My Fights Against Fidel.
- #22 August 1979: Mad Mike's Mercs in the Congo; Saigon: The Toughest Beat in the World; Handgun Stopping Power.
- #23 September 1979: World Practical Pistol Championship; Duel of Master Snipers; South African Motorcycle Troops.
- #24 October 1979: White Devil of Mozambique; Sidewinder SMG; Contact Lenses for Shooters.
- #25 November 1979: Chopper Jobs; Nicaragua: The End; In Memoriam: Col. "Bull" Simons; Return to Paris Island.
- #26 December 1979: Korean Combat of Nerves; SOF with Border Patrol; Strategist Plots WWII.
- #27 January 1980: Stakeout; Rizzo's Raiders; Field Gear Needs Face Lift; Cobray School.
- #28 February 1980: Shootout: .45 vs. 9mm; Only U.S. POW to Escape During SE Asian War; Soviet Black Berets.
- #29 March 1980: Soviet Nuclear Plans; West Germany's GSG 9; Will Volunteer Army Fight?
- #30 April 1980: Texas Airborne NG; SOF Interviews Afghan Rebel

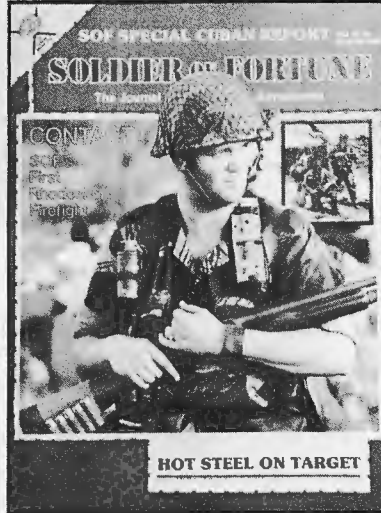

Leader; Angolan Border Fire Fight.

- #31 May 1980: Bushmen — Montagnards of South Africa; Kings of the Khyber Rifles; Khe Sanh; Camerone
- #32 June 1980: Vietnam Delta Ambush; Wolf Pack Skipper; RSAs Cuban Killer.
- #33 July 1980: MGs for Rent; Vietnam: Why We Went, Why We Didn't Win; SOF Takes a Dive.
- #34 August 1980: Gunfight at Fort Hustler, RVN; SOF: Contact in Rhodesia; Marine Desert War Exercises.
- #35 September 1980: Assignment Afghanistan; In Cuban Waters; SAS Dares and Wins.
- #36 October 1980: Jihad in Afghanistan; Soviet Special Forces; Shot in the Heart.
- #37 November 1980: SMGs Find Home on the Range; Bringing Smoke on SWAPO; Stunt Pilot's Plot.
- #38 December 1980: Vietnam: Howard's Hill; Morocco's Desert War; Ruger's Mini-14.
- #39 January 1981: Sharpshooting with Chairman Jeff; Anatomy of a Combat Knife; Cambodia: Journey into Hell.
- #40 February 1981: AK-47; Hanoi's Hit List; Recruiting Scams; SOF Convention Report.
- #41 March 1981: Morocco's Murderous Marauders; Cold Weather Operations; Escape & Evade from Angola.
- #42 April 1981: Afghanistan's Winter War; SAS at War in Malaya; Betrayal in North Korea.
- #43 May 1981: Sex & Psywar; Marine Recon; SOF Staffer Inside Afghanistan.
- #44 June 1981: SOG Special; POW/MIAs in SE Asia;

- The Punch for the Crunch.
- #45 July 1981: Making War Movies; Angola: The War the World Forgot, Part 1; Vietnam Experience.
- #46 August 1981: Angola, Part 2; Ulster Defense Regiment; Marine Recon.
- #47 September 1981: SOF Tests the UZI; A Day With Nicaragua's Jackals; Red Trail in Africa.
- #48 October 1981: South Africa's Boys in the Bush; USMC Gears Up for the Future; U.S. Army Ranger School.
- #49 November 1981: The War in El Salvador; Our Man in Beirut; IPSC Nationals.
- #50 December 1981: "Rebel" in Rhodesia; French Foreign Legion; Nightmares from 'Nam.
- #51 January 1982: Laos — The War That Never Ended; Springbok Raid Grabs Russians; Leatherwood SMG.
- #52 February 1982: Thailand's Battle Road; 1981 SOF Convention; Killing for Mother Russia; USSR's Awesome AGS-17.
- #53 March 1982: Seychelles Merc Fiasco; H&K G-11 Caseless Gun; 1981 SOF Shoot; SOF Interviews Israel Gallil.
- #54 April 1982: Rough & Ready Army Rangers; Capt. Dring's Private Navy; Vinnell's Saudi Arabian National Guard.
- #55 May 1982: Beyond Angola's Border; Leatherwood State-of-the-Art Scope; Air Assault into LZ Hell.
- #56 June 1982: FN FAL; Alexander Solzhenitsyn Speaks Out; SOF Uncovers Sidearm Snafu.
- #57 July 1982: Make Mine M14; Soviet Surrogates at U.S. Army National Training Center; USAF Spectre.
- #58 August 1982: American Merc in Lebanon; M249 SAW; SOG in Cambodia.
- #59 September 1982: CETME MG82; Southern Philippines' Shadow War; Spanish Foreign Legion.
- #60 October 1982: Death on Africa's Skeleton Coast; Bullets and Ballots in El Salvador; SOF's Thai Balloon Jump.
- #61 November 1982: SOF Inside Afghanistan; M16 and Military Marketeering.
- #62 December 1982: Global Warfare Special — SBS and SAS in the Falklands; Lebanon; Afghanistan.
- #63 January 1983: War in South West Africa; Life and Times of Hilaire du Berrier; Taiwan's Tunnel Vision.
- #64 February 1983: SOF Fires AGS-17; Gringo in El Salvador's Bush; Britain's Gurkhas.
- #65 March 1983: Peru's Weird Warriors; SOF Convention '82; Viet Vet Salute.
- #66 April 1983: Bloody la Drang; SOF and the KGB; China's American Hero; SOF Three-Gun Match.
- #67 May 1983: AKS-74; SOF Looks at LRRPs; CIA's Korean Caper.
- #68 June 1983: Appointment in Angola; USS *Ranger*; MX Peacekeeper.
- #69 July 1983: Operation Hastings, RVN; Central America — the War on Our Doorstep; Inside Free Angola.
- #70 August 1983: Costa Rica; Falkland War Weapons; Ivan's Army.
- #71 September 1983: Crisis in Central America; Correspondent Hitches Up With the Cavalry in II Corps; Soviet RPK-74.
- #72 October 1983: SOF Goes to the Movies — *The Final Option* and *Blue Thunder*; Richard M. Nixon on El Salvador; Korea Waits for War.
- #73 November 1983: SOF Joins Marines in Lebanon; Bob Denard, Master Merc; Yanks in Honduras.
- #74 December 1983: SOF Exclusive Reports on War Around the World From Afghanistan to Angola.

SOF Back Issues, Dept. SF990 • P.O. Box 693 • Boulder, CO 80306

YES, Send me (Write In Issue Numbers):

| | | |
|---------------------------|---------------------------|---------------------------|
| 1st Issue # _____ \$5.00 | 2nd Issue # _____ \$5.00 | 3rd Issue # _____ \$5.00 |
| 4th Issue # _____ \$5.00 | 5th Issue # _____ \$5.00 | 6th Issue # _____ \$5.00 |
| 7th Issue # _____ FREE | 8th Issue # _____ FREE | 9th Issue # _____ FREE |
| 10th Issue # _____ \$5.00 | 11th Issue # _____ \$5.00 | 12th Issue # _____ \$5.00 |

- I Have Enclosed \$30 For 9 Issues (a \$45 Value)
- I Have Enclosed \$45 For 12 Issues and a Binder (a \$70 Value)
- I Have Enclosed \$_____ For The Issues Indicated Above (\$5 each)

Foreign Orders Add: \$3 for 1st issue; \$1 Each Add'l. Issue.

Visa or Mastercard Orders: Number _____

Exp. Date: _____ Signature _____

Name _____

Street _____

City, State, Zip _____

apprehended on 24 April 1963. Many other members of the PCE (Communist Party of Ecuador), who were concentrating on subverting military personnel, were also apprehended in this time frame.

As an interesting sidelight, the morning of 27 June 1963 Veronica Denise Breslin, Major Ed Breslin's 18-year-old daughter who was not privy to the bold plans of her father, had been enjoying a drive through the countryside. As she returned to Quito, she was puzzled by the fact that all she could hear on the car radio was the national anthem of Ecuador, played over and over again. When she reached the first roadblock it suddenly became apparent that something of great significance was in progress. She could not know that Carlos Julio Arosemena was about to come under siege at the presidential palace.

Arosemena held out until 11 July, holed up in the presidential palace and drinking heavily. When tanks and troops surrounded the palace Arosemena was still not disposed to surrender, but there never was a firefight. El Presidente fired several rounds from his handgun, but his fire was not returned — the last thing anybody wanted to do was make a martyr out of the SOB. Once Arosemena was disarmed and taken into custody in the presidential living quarters, he was given an injection of a strong tranquilizer. He was then transported, with his aide de camp Capt. Morales and his secretary Horacio Borja, to the airport for a one-way flight to exile in Panama.

As events unfolded it was impossible for U.S. officials not to be aware of Breslin's role in the coup. No one agency or department took any specific action against Breslin, but he was quickly transferred to Fort Amador in the Canal Zone. He was assigned a lackey's job — nothing to do with the deposed Arosemena who was in exile nearby. I saw him and the family on several occasions and he was very bitter about the assignment he had been given. He was later transferred to Fort Belvoir in an equally "blah" job in 1964, and then he put in for retirement. It was hardly a proper ending for a man who had achieved the impossible in intelligence operations.

Ed Breslin retired from the U.S. Army as a major, and died in 1985. He now rests on a grassy hillside in Arlington National Cemetery that looks right down on the Pentagon. One might say he is back on guard post number one, just as he was at the beginning of his career.

In 1983, 20 years after this incident, Veronica Breslin and C.R. McQuiston were married.

Charles McQuiston enlisted at the age of 17 and served with the 14th USAAF in the CBI theater. After WW II he served with occupational forces in Japan and subsequently attended Ohio State University, returning to active duty as an artillery officer. After a combat tour in Korea he transferred to the CIC for tours in Europe, Central and South America, and



Camillus salutes the U.S. Armed Forces.

Camillus Cutlery Company commemorates the 50th anniversary of World War II with a limited-edition set of finely crafted, authentic combat knives.

Dedicated Camillus craftsmen carefully hand make these knives with the same proud workmanship that their fathers demonstrated in the 1940's.

Today's commemoratives include the Navy Mark 2 Knife, the M-3 Army Trench Knife, the Marine Combat Knife, and the Air Force Pilot Survival Knife. All are inlaid with 18 karat gold U.S. Service Seals and presented in a genuine oak display case.

Camillus Cutlery Company
Camillus, New York 13031



International Security Services, Inc. We Export

Concealable "Bug" Detector • Time Event Recorder with Surveillance Cameras • Secure Phone II • RF Detecting Clock • 10 Hr. Recorder



We also carry a complete line of VHF and UHF Long Range wireless transmitters • Scramblers • Night Vision • Body Armor • Personal Security Devices • Customized Security Systems.

Our Company also specializes in extensive worldwide corporate security training, K-9 training, and security consultation.

To receive our latest edition security catalog with state-of-the-art equipment, please send \$20.00 (refundable towards your first purchase) and the enclosed coupon to:

International Security Services, Inc.
P.O. Box 1037
Deerfield Beach, FL 33443

Please send _____ catalogs SF
at a cost of \$ _____ to:

Name _____

Address _____

City _____

State _____ Zip _____

EXTENDED "SKULL CRUSHER" POMMEL
FULL TANG FOR ABSOLUTE STRENGTH

CONTOURED AMERICAN WALNUT GRIPS

TRIPLE-RIVETED HANDLE

SHOWN 1/2 ACTUAL SIZE

DOUBLE CROSS GUARD

NON-REFLECTIVE BLADE, GUARD & RIVETS

SHARPENED FALSE EDGE

WARRIOR SPECS.

Blade length: 6 5/8"
Length overall: 12 1/2"
Blade thickness: .150"
Weight, knife: 8.6 oz
Weight, sheath: 5.0 oz

REINFORCED POINT

Retail \$69.00

#EKWR **\$49.95**

Your Discount Price

- A BATTLE-PROVEN DESIGN JUST BECAME AFFORDABLE
- POUND FOR POUND, DOLLAR FOR DOLLAR, THE EK WARRIOR OFFERS MORE VALUE THAN ANY OTHER KNIFE IN ITS CLASS!
- REINFORCED NYLON BELT SHEATH INCLUDED

WE STOCK THE FULL EK LINE.
CALL FOR YOUR DISCOUNT PRICE



TOLL FREE ORDER LINE:

1-800-231-1272

FOR INFORMATION CALL: 1-208-376-0430

We're open for your ordering convenience
Mon-Fri 8-5, Sat 9-5 Mountain Time

**Cutlery
Shoppe**

Send mail orders to: CUTLERY SHOPPE DEPT SF
5461 KENDALL STREET, BOISE, IDAHO 83706-1248

SHIPPING & HANDLING (per order): \$5 to 48 states,
\$7 PO Box, APO & FPO - \$10 for COD (48 states only)
\$10 for AK, HI, PR, USVI & CANADA. Foreign orders
(excluding Canada), please write for shipping costs.

PAYMENT: We accept VISA, MASTERCARD, COD (cash only),
MONEY ORDERS & CHECKS (checks allow 21 days to clear)
FAX Machine Orders: 1-208-376-7608

Get our full color catalog for great deals on the top knife brands. Send
\$1 or call 1-208-376-0430 to get your copy. PLEASE, do not call the
"800" number as we reserve these lines for customers placing orders
(catalog free with knife purchase).



**Ek
W
A
R
R
I
O
R**

RAZOR SHARP
WASP-WAISTED
BLADE

WARRIOR SHOWN
IN SHEATH



Vietnam. After retirement as a lieutenant colonel, McQuiston pioneered the concept of voice stress analysis, and for some 30 years has been the leading authority in that field. He is presently president and chairman of the board of Verimetrics Systems, Inc., which develops and markets VSA instrumentation and trains voice stress examiners. ✕

PROFILE IN COURAGE

Continued from page 43

Navy doctor, but med school interviewers said he was too old for the program at 27. He joined the Denver Police Department in 1982 and Metro/SWAT in 1986. Of the nearly 800 busts Denver's Task Force has executed since 1987, Ron has worked point on some 70 percent of those done by SWAT on the night shift. In 1989, he responded when a woman barricaded herself in a motel room. When she shot at the police negotiator, Ron shot at her but missed. Then he leaped through an open window and disarmed her.

"You can't function daily as a policeman thinking like you did as a soldier," he says. "But SEAL training gives you a real advantage because you learn to perceive danger — to see things before they come at you."

When Ron's supervisor arrived at the scene, Ron traded his SIG-Sauer for a replacement and made a statement to the District Attorney. Then he went home to bed.

"I thought, 'Well, the taxpayers got their money's worth tonight. I earned my pay,'" he told me.

The Denver Police Department believed he deserved more: Ron received its Medal of Honor — and is the Colorado Police Protective Association's Police Officer of the Year.

"Because of his superb training, prior experience and professionalism, he was able to act quickly to neutralize the suspect while preventing injury to others," wrote Denver D.A. Norman S. Early, Jr. and Assistant D.A. Chuck Lepley after their investigation of the incident. "This sound judgment, courage and quick action allowed Relf, while under direct fire, to push the woman and young child to safety and return fire."

Ron shrugs and quotes the acronym "FIDO" — Forget It, Drive On. He says he was just doing his job, that any of his team members could have done it.

"It's the Blue Knight syndrome," he says. "For eight hours, you protect the world."

"Besides," he adds, "every night you have a call out and you go home afterward, you've won some kind of award."

Morgan Tanner is a frequent contributor to SOF and penned "SWAT Olympics" in this issue. ✕

10,000 FIREARMS BARGAINS

Are you a gun trader? Gun collector? Or are you just plain interested in guns?

If you are, you'll profit from reading the bargain-filled columns of **SHOTGUN NEWS**, now published 3 times each month. It's the leading publication for the sale, purchase and trade of firearms and accessories of all types. **SHOTGUN NEWS** has aided thousands of gun enthusiasts locate firearms, both modern and antique — rifles, shotguns, pistols, revolvers, scopes, mounts... all at money-saving prices. The money you save on the purchase of any one of the more than 10,000 listings 3 times a month more than pays your subscription cost. You can't afford to be without this unique publication.



Free Trial Offer!

Money Back Guarantee.

That means you get 36 big issues. What's more, if you're not completely satisfied, just tell us. We'll immediately refund your money in full and you can keep the issues you already have. Fair enough? You bet! Fill in the coupon below and mail it today!

SAMPLE COPY • \$3.00

Shotgun SOF
News

The Trading Post
for anything
that shoots.

Box 669, Hastings, NE 68902

MasterCard 1-402-463-4589 **VISA**

Yes, Start my subscription to **SHOTGUN NEWS** for 36 issues, **\$18.00** enclosed — to be refunded if I'm not completely satisfied.

Name _____

Address _____

City _____

State _____ Zip _____

Card Number _____ Exp. Date _____

FOREST OF ASSASSINS

Continued from page 89

building on Couch to abort. This mission was dangerous enough if all went well.

Walt Gustaval, who was now on his third Vietnam deployment, was of the opinion that they were close and that this one "felt like a good one."

The decision was made to go through with the mission. The team now had to work hard against the current but finally found the mouth of the right canal 100 meters from the first. Still no radio contact with the Medium.

The canal twisted and turned with some 90-degree bends; with first light 30 minutes away, the team was approaching the objective when the silence was broken by a cough in the dark. It was the cough of someone asleep — probably a sentry. Couch signalled the lead sampan to move in, and they slid ahead into the night. Third Class Petty Officer Tim O'Farrell efficiently handled the task before him and within five minutes a small red dot of light signalled that the sentry was secured.

Couch's sampan joined the lead sampan and he climbed into the rickety structure that was the guard post. His penlight revealed a scared and confused VC — he wasn't giving any information.

Couch tried everything from increasing threats of violence to offers of money — no dice. Finally, in frustration, Couch took his K-bar knife and placed it at his throat. No dice. Just then one of the Kits asked if he could try. Relieved, Couch stepped aside. The Kit leaned down and spoke to the VC in Vietnamese, "You know who I am and what I will do if you don't talk." Suddenly the VC couldn't tell the SEALs enough about the camp.

The camp was 100 meters further up the canal and did have POW (all ARVN). There was a small security force with only a few light automatic weapons. The SEALs regagged the VC, tossed him in the third sampan and headed on up the canal.

Couch was still worried about no radio. No radio meant no boat support and no Seawolves, so he decided to ready a pop flare. The boat could find them from the flare. The plan called for the flare to go up after first contact with the team advancing in a skirmish line.

Quickly the camp appeared. The sampans were grounded silently, and the team prepared to advance. Couch stood cautiously to survey the situation and dropped the pop flare. It made the sound of an empty beer can dropped on a patio deck on a quiet night. He picked it up quickly and fired it into the air.

Tracers started flying everywhere with the VC's colored green and the SEAL tracers red. The Kits were charging into the camp firing while the SEALs madly looked for the prisoner cages.

The camp was quickly overrun and second squad, headed by Lt. John Sandos

CLIPS



ARAPAHO TRADING POST, Inc.
P.O. Box 5366
Woodland Park, CO 80866
(719) 633-6329

\$50.00 MINIMUM ORDER

| | | | | | |
|----------------------|---------|-----------------------|-------|----------------------|-------|
| AK-47 30 rd. Bl. | \$16.50 | MAC 10 36 rd. 9mm | 14.50 | S&W M59 30 rd. Bl. | 21.50 |
| AK-47 55 rd. Bl. | 55.50 | Marlin Camp 30 rd. | 21.50 | SIG P220 12 rd. Bl. | 31.50 |
| AP 9 50 rd. | 29.50 | M1 Carb 5 rd. Bl. | 4.75 | SIG P226 & 8 25 rd. | 31.50 |
| AR 15 40 rd. 223 | 15.75 | M1 Carb. 30 rd. Bl. | 4.75 | Sp. Fid. P-9 15 rd. | 18.50 |
| AR 180 40 rd. Bl. | 15.75 | M1 Carb. 30 rd. Str. | 7.50 | Sp. Fid. P-9 25 rd. | 31.50 |
| AT-84 9mm 15 rd. Bl. | 17.50 | M1 Carb. Jungle Clip. | 3.75 | Star B 9mm Bl. | 14.75 |
| AT-84 9mm 25 rd. Bl. | 29.75 | Mini 14 20 rd. Bl. | 8.75 | Star BK & BKM 9mm | 14.75 |
| Browning 9mm 13 rd. | 13.50 | Mini 14 20 rd. Nkl. | 13.75 | Star PD 45 Bl. | 14.75 |
| Browning 9mm 22 rd. | 17.50 | Mini 14 20 rd. Str. | 14.75 | TA-90 15 rd. Bl. | 18.50 |
| Browning 9mm 30 rd. | 21.50 | Mini 14 30 rd. Bl. | 9.75 | TA-90 25 rd. Bl. | 31.50 |
| "Colt 45 Auto" Bl. | 3.95 | Mini 14 30 rd. Nkl. | 14.75 | Taurus 9mm 25 rd. | 31.50 |
| Colt 45 Auto St | 6.75 | Mini 14 30 rd. Str. | 18.75 | TEC 9-KG 9 36 rd. | 14.50 |
| Colt 45 12 rd. Bl. | 13.50 | Mini 14 40 rd. Bl. | 15.75 | TEC 9-KG 9 50 rd. | 32.50 |
| Colt 45 20 rd. Bl. | 16.50 | Mini 14 40 rd. Nkl. | 22.75 | TZ-75 15 rd. Bl. | 18.50 |
| Colt 45 25 rd. Bl. | 17.50 | Mini 14 40 rd. Str. | 26.75 | TZ-75 25 rd. Bl. | 31.50 |
| CZ 75 9mm 15 rd. Bl. | 15.75 | Mini 30 10 rd. Bl. | 17.75 | UZI 9mm 25 rd. used | 6.50 |
| CZ 75 9mm 25 rd. Bl. | 38.50 | Mini 30 30 rd. Bl. | 32.50 | UZI 9mm 32 rd. | 15.50 |
| H-K 91 30 rd. Bl. | 46.50 | Mini 30 50 rd. Bl. | 55.50 | UZI 9mm 50 rd. | 31.50 |
| Llama 22 15 rd. Bl. | 16.75 | Rem. 740-2 10 rd. | 16.75 | Walther PP&KS 22 | 16.75 |
| Llama 380 15 rd. Bl. | 16.75 | Ruger Mk1&2 Bl. | 9.75 | Walther PP&KS 380 | 9.50 |
| Llama 45 15 rd. Bl. | 17.75 | S&W M39 15 rd. Bl. | 15.75 | Walt. PP&KS 380 Str. | 9.75 |

NO LICENSE REQUIRED

MC/VISA ADD 3%

ORDERS OVER \$500.00 DEDUCTS 5% AND SHIPPED FREE

YOU DON'T NEED CASTRO'S PERMISSION TO ENJOY THE UNIQUE HAVANA FLAVOR!

CUBAN-SEED-LEAF CIGARS FOR THE MAN WHO THOUGHT HE COULDN'T AFFORD THEM!

I'll send them to you from Tampa, the fine cigar capital of the world. Sample the cigars in my new Sterling Sampler and enjoy a wonderful new smoking sensation. I'll include a generous sampling of vintage-leaf, long-filler and cut-filler cigars, all perfectly blended for mildness and flavor.

These superb smokes are made with expertly blended Cuban-seed-leaf tobaccos grown and cured the old Cuban way in Honduras from seed smuggled out of Cuba. They're mild, flavorful and extremely satisfying to the cigar smoker who's looking for something new, something better, something exceptionally tasty. Experts can't tell them from Havanas. You won't be able to either, when you try them. Natural wrapper. If you're ready for a luxuriously enjoyable smoking experience, try them now.



GIFT IDEA!
SEND CIGARS TO A FRIEND

MY OFFER TO CIGAR LOVERS

I'll send you postpaid a selection of 42 factory-fresh cigars — vintage-leaf long-filler and cut-filler smokes. If these cigars aren't all you expected, return the unsmoked ones by United Parcel or Parcel Post within 30 days and I'll refund your money. No questions asked. Your delivered cost is only \$10.90 for 42 factory-fresh, Cuban-seed-leaf cigars.

THOMPSON CIGAR CO. Dept. BB27

5401 Hangar Ct., Box 30303, Tampa, FL 33630

O.K., TOM! Ship me the Sterling Sampler under your money-back guarantee for only \$10.90.

Check for \$10.90 enclosed (Fla. residents add 6% sales tax)
 Charge \$10.90 to my VISA MasterCard American Express Diners Club
PLEASE PRINT

Credit Card No. _____ Exp. Date _____

name _____

street _____

city _____ state _____ zip _____

OFFER GOOD IN U.S. ONLY

CREDIT CARD USERS
SPEED DELIVERY BY CALLING

**TOLL-FREE 1-800-237-2559
IN FLORIDA, CALL: 1-800-282-0646**

SPYDERCO



G-2 HIGH CARBON
STAINLESS STEEL
BLADE

RAZOR SHARP
SPYDER EDGE
SERRATIONS

CLIPIT

ENDURA

THUMB HOLE
FOR QUICK
OPENING

POSITIVE FRONT LOCK,
ONE HAND RELEASE
(AL MAR DESIGN)

"VOLCANO GRIP" TEXTURING
PROVIDES A SECURE GRIP,
EVEN WHEN WET

INTEGRAL POCKET CLIP
FOR EASE OF CARRY &
RETRIEVAL

LIGHTWEIGHT, YET TOUGH
DUPONT ZYTEL® GRIPS

LANYARD HOLE

Retail \$40.00
#SP1010RS SPYDER EDGE
#SP1010RP PLAIN EDGE

ENDURA SHOWN
IN POCKET

OUR PRICE TOO LOW
TO ADVERTISE, CALL
FOR YOUR DISCOUNT PRICE



ENDURA SPECS.

Blade length: 3 7/8"
Length open: 8 1/2"
Length, closed: 4 3/4"
Blade thickness: 1/8"
Weight, knife: 2.7 oz

• TO SHARPEN YOUR ENDURA CLIPIT WE RECOMMEND THE TERRIFIC SPYDERCO TRI-ANGLE SHARPMAKER FOR \$29.95, ORDER CODE #SP203MF.

WE STOCK THE FULL SPYDERCO LINE,
CALL FOR YOUR DISCOUNT PRICE



TOLL FREE ORDER LINE:

1-800-231-1272

FOR INFORMATION CALL: 1-208-376-0430

We're open for your ordering convenience
Mon-Fri 9-5, Sat 9-5 Mountain Time

Cutlery Shoppe

Send mail orders to: CUTLERY SHOPPE DEPT SF
5461 KENDALL STREET, BOISE, IDAHO 83706-1248

SHIPPING & HANDLING (per order): \$5 to 48 states,
\$7 PO Box, APO & FPO -- \$10 for COD (48 states only)
\$10 for AK, HI, PR, USVI & CANADA. Foreign orders
(excluding Canada), please write for shipping costs.

PAYMENT: We accept VISA, MASTERCARD, COD (cash only),
MONEY ORDERS & CHECKS (checks allow 21 days to clear)
FAX Machine Orders: 1-208-376-7608

Get our full color catalog for great deals on the top knife brands. Send
\$1 or call 1-208-376-0430 to get your copy. PLEASE, do not call the
"800" number as we reserve these lines for customers placing orders
(catalog free with knife purchase).

(currently Group 2 commander), set up perimeter security. Meanwhile, Natter had spotted the flare and placed the Seawolves over Couch's position while Natter made his way up the canal in the Medium.

The radio had now come up and a slick was called in with the other SEAL squad to help out if the VC rallied and returned.

Couch and one of his men fired up that most indispensable SEAL Mekong Delta weapon — the chain saw — and started cutting trees for a helo landing zone to extract the two VC prisoners, 19 ARVN POW, and an old woman and her daughter who had been pressed into cooking duty by the VC.

It took an hour and a half for the helos to pull everyone except the SEALs and Kits out of there. The helos couldn't touch down but would hover about 5-6 feet off the ground with the crews helping people in.

The SEALs would extract via the Medium back down the 2,000 meters of the canal to Square Bay. However, both Couch and Natter were worried about the possibility of a VC ambush set up along the canal, so they had the Seawolves blasting both banks with their .50 calibers.

In the din of the Seawolf fire, Couch and Natter saw what appeared to be muzzle flashes from both banks. They both jumped to the Medium's forward machine guns and started blasting away. So intent were they that they failed to notice the rest of the SEALs laughing their asses off in the back of the boat. The Seawolves were firing APIT (Armor Piercing Incendiary Tracers) that exploded on impact — thus the muzzle flashes.

The SEALs made it back to Solid Anchor that night, and Whiskey Platoon would find it difficult to match the success and excitement of their first combat operation.

Steve Edwards specializes in writing about naval unconventional warfare. This is his second article for SOF having previously penned "The Last Detail," June '90. Look for Richard Couch's book SEAL One by Avon Books early in 1991.

IN REVIEW

Continued from page 30

R. Shoemaker, a former MIS-X operative who breaks a 45-year silence and tells all; and **The Forgotten Soldier** — The Classic WWII Autobiography (Brassy's (U.S.), Inc.) by Guy Sajer, the finest account ever written about life on the Eastern Front as seen through a German soldier's eyes.

For the serious student of war comes the three-volume **The Lessons of Modern War** (Westview Press, (303) 444-3541) by Anthony H. Cordesman and Abraham R. Wagner, an exceptionally detailed and incisive look at the

AK47 • AKS • AK22 • AR15

YOU'LL NEVER GET THIS CLOSE...

39.95
POST
PAID

to FULL AUTO, that is!



"ABSOLUTELY AMAZING"
..Guns & Ammo
"INCREDIBLE"
..Guns Magazine
"BEST LEGAL FULL AUTO"
..Soldier of Fortune
"THE CLOSEST THING
TO FULL AUTO"
American Survival Guide

Tri-Burst™ with "INERTIA-FIRE"
TRIGGER ACTIVATOR

YES! This all NEW "Tri-Burst"™ with "Inertia-Fire"™ will enable most any semi-automatic to fire 3 to ALL shots at a full automatic-type rate legally. The "Tri-Burst"™ installs in seconds and does not interfere with the normal operation of the trigger.

Get yours NOW while you STILL CAN!

FOR PROMPT DELIVERY: Cashier's Check/Money Order.
Send. Name, Address, Type of Weapon (important) and
\$39.95 complete. Colorado residents add 3%.

* NOTE: INERTIA-FIRE™ WILL ONLY FUNCTION ON WEAPONS WITH
ADEQUATE RECOIL AND REQUIRES PRACTICE

DEALER INQUIRIES WELCOME



ORPHEUS INDUSTRIES, INC.
P.O. BOX 1415 • MONTROSE, CO 81402
FOR MASTER CHARGE/VISA CALL (303) 249-0108

MINI 14, 30-HK91, 93, 94 • GALIL • FNC

JEFF COOPER'S AMERICAN PISTOL INSTITUTE



... THE CRISIS MANAGEMENT SPECIALISTS ...

Take the initiative and dominate your environment. Train with the professionals at API. Learn modern weaponcraft: practical shooting, skillful gunhandling, mental conditioning and applicable tactics with Jeff Cooper and the incomparable API staff.

Consider the API Advantage:

- We originated and have continuously evolved modern smallarms techniques.
- We offer courses in rifle, pistol, and shotgun (machine pistol by departmental arrangement) for every level—introductory, refresher, remedial, intermediate, and advanced.
- Our curricula are based on extensive research into smallarms conflict, both in the past and as now occurring. We teach what happens.
- Our student-teacher ratio is three-to-one on the range and one-to-one in tactical simulation.
- We are a complete private smallarms training facility, encompassing over twenty firing ranges and indoor/outdoor tactical simulators, plus gunsmithing services on the premises.
- We also provide off-campus and customized courses for military, government, law enforcement and private audiences, anywhere in the free world.

WE ARE "THE FIRST WITH THE MOST"

For more information about courses
and current scheduling, write:



AMERICAN PISTOL INSTITUTE
P.O. BOX 401-S
PAULDEN, ARIZONA 86334

Say it with a T-shirt
from the SOF Exchange.



#1033 POW/MA, blue.
Remember! \$9.95



#1002 Peace, white.
An eye-catcher. \$9.95



RHODESIAN
ARMY

#1027 Rhodesia,
white. Strong. \$9.95



38-40 SURAWONG ROAD
BANGKOK

#1025 Lucy's Tiger
Den, white. \$12.95



LAS VEGAS, NEVADA

#9089 SOF Con-
vention, white. \$9.95



#1035 Assault, white.
A favorite. \$10.95



#1024 Khadaffi, blue.
Extra nice logo. \$10.95



#1032 Los Contras,
aqua. New! \$9.95



LAS VEGAS, NEVADA

#9289 Championship
Match, white. \$9.95



#1031 Aeroflot, silver.
Esoteric. \$10.95

SOLDIER OF
FORTUNE

#1001 SOF logo, black.
Clean, strong. \$9.95

SOF EXCHANGE

P.O. Box 687 DEPT 10-90
Boulder, CO 80306 USA

Call Toll-Free for Mastercard or VISA
orders: **1-800-323-1776**, Operator
131. For FAX orders: (303) 444-5617.
Customer Service: (303) 449-3750.

PAYMENT: VISA MC CHECK
CARD # _____ EXP _____
NAME _____
ADDRESS _____
CITY _____ STATE _____ ZIP _____

| QTY. | ITEM NO. | SIZE | PRICE |
|----------------------------------|----------|------|-------|
| | | | |
| | | | |
| | | | |
| | | | |
| SUB TOTAL | | | |
| P&H | | | |
| 3.7% Sales Tax (Colo. Residents) | | | |
| TOTAL | | | |

T-Shirt sizes S, M, L, XL. \$1.00 extra for XXL.
Add \$3.00 for first item ordered plus \$1.00 per
each additional item for postage and handling.
Overseas orders add 40%. Allow 4-6 weeks for
delivery.



IN CANADA

MILARM CO. LTD. 10769-99 ST.
EDMONTON, ALBERTA T5H 4H6
PHONE 403-424-5282 FAX 403-424-5306

COLD STEEL

REINFORCED
CLIP POINT BLADE

**S.
R.
K.**

SHOWN 1/2
ACTUAL SIZE

PARKERIZED
BLADE FINISH

FACTORY-HONED
RAZOR SHARP

CARBON 5
BLADE

S.R.K. SHOWN
IN SHEATH



INTEGRAL
GUARD

CHECKERED
HANDLE
PROVIDES A
NON-SLIP
GRIP, EVEN
WHEN WET

COMFORTABLE
KRATON HANDLE

LANYARD HOLE

FULL TANG,
FULL STRENGTH

S.R.K. SPECS.

Blade length: 6"
Length overall: 10 3/4"
Blade thickness: 3/16"
Weight, knife: 8.4 oz
Weight, sheath: 2.3 oz

Retail \$50.00
#CSSRK
Your Discount Price **\$39.95**

- BLACK CORDURA BELT SHEATH INCLUDED
- PROUDLY MADE IN THE USA, THE S.R.K. IS A FANTASTIC KNIFE, AT AN INCREDIBLE PRICE!

WE STOCK THE FULL COLD STEEL LINE,
CALL FOR YOUR DISCOUNT PRICE



TOLL FREE ORDER LINE:

1-800-231-1272

FOR INFORMATION CALL: 1-208-376-0430

We're open for your ordering convenience
Mon-Fri 8-6, Sat 9-5 Mountain Time

**Cutlery
Shoppe**

Send mail orders to: CUTLERY SHOPPE DEPT SF
5461 KENDALL STREET, BOISE, IDAHO 83706-1248

SHIPPING & HANDLING (per order): \$5 to 48 states,
\$7 PO Box, APO & FPO -- \$10 for COD (48 states only)
\$10 for AK, HI, PR, USVI & CANADA. Foreign orders
(excluding Canada), please write for shipping costs.

PAYMENT: We accept VISA, MASTERCARD, COD (cash only),
MONEY ORDERS & CHECKS (checks allow 21 days to clear)
FAX Machine Orders: 1-208-376-7608

Get our full color catalog for great deals on the top knife brands. Send
\$1 or call 1-208-376-0430 to get your copy. PLEASE, do not call the
"800" number as we reserve these lines for customers placing orders
(catalog free with knife purchase).

Arab-Israeli conflicts (Volume I), the Iran-Iraq war (II), and the Afghan and Falklands conflicts (III).

A different type of war, but just as deadly, is chillingly recounted in **Drug Lord** - The Life and Death of a Mexican Kingpin (Pharos Books) by Terrence E. Poppa, an investigative reporter who tracks the rise of Pablo Acosta (who yearly smuggled some 60 tons of cocaine into the United States) until his abrupt — and terminal — fall at the hands of Mexican police and federales.

America's longest running (so far) foreign engagement produced enough books to fill a catalogue, and that's the format Ben McDonald's **The Vietnam Book List** has taken. With some 2,600 entries, McDonald's compiled the A-to-Z of books on Vietnam, and **The Vietnam Book List** is offered in two ways. The standard loose-leaf bound version can be purchased for \$19.95, or for \$34.95 you can buy the deluxe version which offers a biannual update for two years and a 20-percent discount on the annotated edition, to be published in early 1991. Contact the publisher directly: Bibliographies Unlimited, Dept. SOF, P.O. Box 873, Conifer, CO 80433.

Finally, we'd recommend **Invasion** — The American Destruction of the Noriega Regime in Panama by David S. Behar, Godfrey Harris and SOF contributor Ross W. Simpson, a photo-heavy documentary of our latest (and most contemporarily successful) political/military muscle-flexing endeavor, available for \$29.95 plus \$3.50 p&h from The Americas Group, Dept. SOF, 9200 Sunset Blvd., Suite 404, Los Angeles, CA 90069.

Just because Reagan's "Evil Empire" has self-destructed doesn't mean your need to stay informed about military affairs has gone the same route. There are enough bad guys out there to keep us all busy for a long time to come! ✂

FLAK

Continued from page 24

The "right to keep and bear arms" guarantees the other freedoms in the Bill of Rights.

We are now faced with a problem in our country. We have people who seek to relieve us of those rights.

How can mere humans usurp freedom given us by the Creator? They can't. Not unless we allow them to. If we do not exercise our freedoms, we deserve to lose them. If we feel something is more important than our continued rights then we will not notice their loss until the time to save them has passed.

**"KILLING IS OUR
BUSINESS AND
BUSINESS WAS
GOOD!"**



NEW NAVY SEAL VIDEO

The **INSIDE STORY** of Navy SEALs fighting in Vietnam. Explains the intimate details of SEAL training & tactics. ExSEALs discuss their roles as Naval Special Warfare Operators. Includes rare footage shot in Vietnam by SEAL team I members. Explosive action video reveals why Navy SEALs were the most feared animals in the jungle! This tape's on permanent display at the UDT/SEAL MUSEUM. 30 minutes color

**"US NAVY SEALS: AN
INSIDE LOOK" \$29.95**

available @ \$19.95 each

"NAVY SEALS: ON PATROL"

"NAVY SEALS: VIETNAM"

"MEN WITH GREEN FACES"

"SOMEONE SPECIAL"

"SUB TRUNK TRAINING"

"THE LONELY WARRIOR"

"NAVY FROGMAN"

ALL TAPE SALES BENEFIT UDT/SEAL MUSEUM. Send check or MO to: **LOTI GROUP PRODUCTIONS DEPT "S" 13891 N. Kendall Dr. Suite #64 Miami, Florida 33186.** Florida residents add 6% sales tax. *Please specify tape titles when ordering.*

But that time has not yet passed. Speak out. Be heard. By protecting the Second Amendment we retain the ability to pass on to future generations all we hold dear.

Sincerely,
Shane A. Justice
APO San Francisco ✉

SOF TECH SCOOPS

Continued from page 79

constructed for this purpose and to visit infantry and armor units. With the advent of the tragic events in Tiananmen Square, SOF abruptly terminated these negotiations. Should the PRC's attitude with regard to human rights and freedom ever take an unexpected turn for the better, we might reconsider such a joint venture. If so, we'll let you know.

SOF's latest tech intel coup came out of El Salvador, a somewhat surprising location as ComBloc nations usually provide their Third World stooges only with well-proven, and often well-worn, technology. I had been tracking a supposedly new and puzzling small arms cartridge since the summer of 1989 when my intelligence sources inside El Salvador had indicated that they had observed a strange cartridge about which U.S. intelligence agencies apparently knew nothing.

From first indications, it appeared that nothing more than a new (possibly sabot) sub-caliber, high-velocity penetrator round was being described. It was not until January 1990 that I received two specimens from "Ed Bishop," an American who had fought alongside the Airborne Battalion during the FMLN offensive in November 1989. At that time it became immediately obvious that we were dealing with some type of subsonic ammunition for a handgun designed for clandestine operations.

As the internal piston was made of aluminum, our initial attempts to X-ray the cartridge, and preserve the specimen intact, yielded little useful information. From the exterior, it also appeared that the primer system might be electrical rather than of the percussion type.

There was no alternative but to perform destructive analysis on at least one of the specimens. To a cartridge collector this would be equivalent to cross-sectioning the Venus of Melos with a diamond saw. But, alas, for investigative science to progress, some of the laboratory rats must die.

With no small amount of trepidation we hacksawed the cartridge latitudinally in half approximately where the X-ray had indicated the base of the bullet was located. We were off somewhat and the tip of the piston got removed as well. However, we could now peer inside the case and it became obvious we had a previously unknown example of captive-piston technology.

Gun Parts & Accessories Supermart!

LLB's Shotgun Mounts Mean **Double Trouble...** **...For AR-15's and M-16's!**



Mounts in Minutes

No Machining or Modifications Required to Your Firearm to adapt Mount
Front Mount Blocks Off Bottom 2 Ports of Flash Suppressor
All Mounts are Machined from Quality Aircraft Aluminum

Mount Systems Available (Order by Part Number):

- M50015 - AR-15/MOSSBERG M500 12 Ga.
- M50016 - M-16/MOSSBERG M500 12 Ga.
- M87015 - AR-15/REMINGTON 870 12 Ga.
- M87016 - M-16/REMINGTON 870 12 Ga.

Call for availability of combinations not listed
Some after market AR-15 receivers require M-16 mounts



\$69.95

Dealer Discounts Available



Send Orders To:

L.L. Baston Co.

PO Box 1995 (SF)

El Dorado, AR 71731

Send \$2.00 for Complete Catalog

Call Toll Free! 1-800-643-1564
or FAX (501) 863-0172

A big glass for a big job.

The Steiner 15x80 Observer.

For border observation, security surveillance, or forward observation there is an increasing need for a high power binocular with low light level operation capability. The Steiner 15x80 Observer is the *high power* that is selected by armed forces and special operations groups worldwide. Built by Steiner, the 15x80 Observer uses many of the current U.S. Army's M-22 low light level capability features. The 15x80 is now available with optional laser filter and compass or reticle systems.

The Steiner 15x80 Observer is built in strict accordance to MIL-I-45208, the most uncompromising quality control specification in the military optics business. For more information, contact Bert Fein, Director of Government Sales.

STEINER The sharpest eyes
in the field.

U.S. Marketing Office: Pioneer
Marketing and Research Inc., 216
Haddon Ave., Westmont, NJ 08108. Phone
1-(800) 257-7742 (In NJ (609) 854-2424). FAX: (609) 858-8695

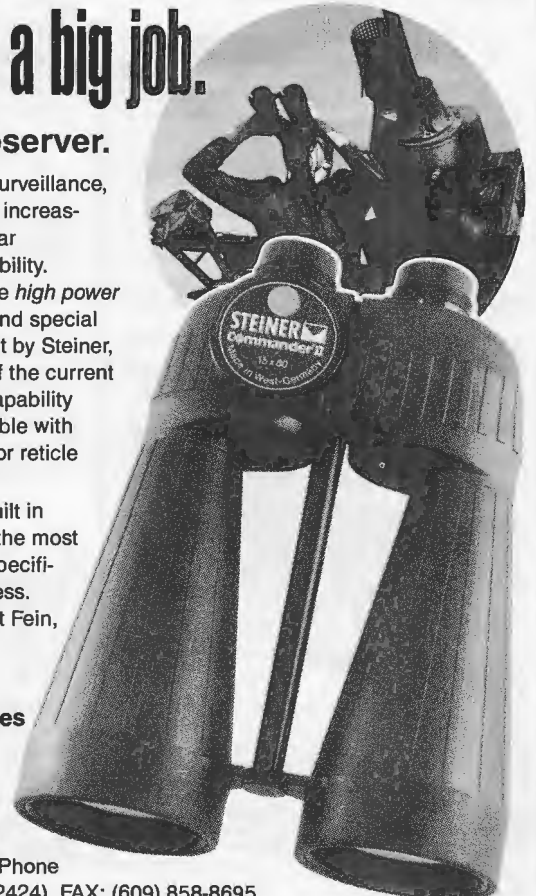

COUNTERFEIT GUNS

FULL-SIZE WORKING REPLICAS MODELS

They're realistic. These classic models look, weigh, feel and handle like the expensive originals. Metal parts are hand assembled; you can spin the cylinders, work the slide action & release the clips. **Completely Safe**

NON-FIRING - DELIVERED FULLY ASSEMBLED

G.I. .45 Automatic

Slide, safeties & action work like original. Can be disassembled. Over 32 metal parts. Lgth. 9.5". Wt. 2.5 lbs.

*#01-300 (Standard Finish)\$107PPD

*#01-300S (Nickel Finish).....\$119PPD



WWII Dagger

German Diplomatic Dress. Lgth. 15". Wt. 1 lb.

#22-4042.....\$40PPD



M92 Military

Slide, trigger & clip work. Can be partially disassembled. Lgth. 8.5". Wt. 3 lbs.

*#22-1254.....\$89PPD

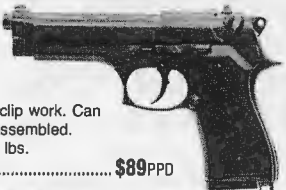

1873 Peacemaker

Single action

works like original, w/wood grips. Can be partially disassembled. Lgth. 11.5". Wt. 2 lbs.

#22-1186/G.....\$59PPD

U.S. Marshal's Badge

Made from original dies.

#14-711.....\$14PPD



1860 Army Revolver

Action works like original, w/wood grips. Can be partially disassembled. Lgth. 13". Wt. 2.1 lbs.

#22-1083/L.....\$60PPD

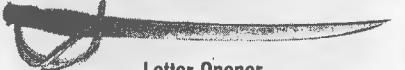

Letter Opener

Miniature detailed Civil War Sabre. Lgth. 8.5"

#22-3005.....\$15PPD

GATLING GUN

WT. 4.5 lbs.
L. 14"
W. 10"
H. 8.5"

Acies Drum Magazine (Removable)

Metal Receiver w/Bronze Antique Finish

10 Barrels that Rotate

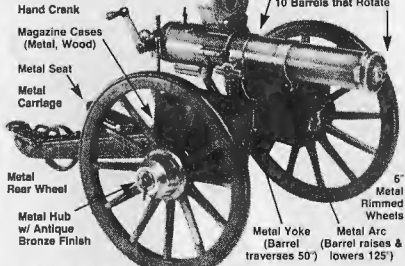

MODEL 1883

A classic 1/8th scale limited edition, w/ metal movable parts.

#22-411.....\$159PPD

COLLECTOR'S ARMOURY, Inc. Dept. SO
P.O. Box 59, Alexandria, VA 22313

*Sold w/orange plug. Not sold to Calif. except for theatrical use.

Send Free Color Catalog

Money Order Check Enclosed Dealer Information

Credit Card Orders—Call Toll Free 1 (800) 544-3456, ext. 515

Name: _____

Address: _____

City/State/Zip: _____

..... Money Back (Less Postage) If Not Satisfied

Even more gingerly, we next sawed the circumference of the case near its base to extract the piston. In so doing, we suddenly observed to our horror that among the steel filings falling to the ground were propellant granules. We were losing the powder charge. Our frantic efforts to sweep the filings and powder granules into a dustpan and separate them with a magnet were to no avail. I was able to determine the charge weight only when the second specimen was cross-sectioned for photography and each granule was removed rather tortuously from a small hole punched into a side of the case reduced in thickness by CNC machinery. The actual cross-sectioning of the second specimen was performed with a carbide-slitting saw after first carefully inerting the primer with WD-40 and acetone.

After the base of the case of our first test specimen was separated from the piston and main body, probing with a fiber optics scope determined that there was no insulator and that the primer system was of the percussion type. Before cutting the base in half longitudinally to examine the primer system, we detonated the primer by placing the base in a vise, surrounding it with towels, and tapping the transfer pin by means of a hammer and a punch held in place with pliers. Once in half, the rather complex primer system lay exposed and the Soviet mortar igniter shell primer could be identified.

Analysis of this type is always laborious, but in this instance resulted in one of the most important tech intel coups of the last decade (see "Mystery Bullet," May '90 and "ComBloc Connection," July '90).

After 15 years of leading the pack in exposing Ivan's newest technology, what do we do for an encore? Stick around and you'll find out. As for Bob Brown and me, we have to catch a TACA Airlines flight to San Salvador. I still haven't fired the assassination Derringer chambered for the 7.62x62, 6mm low-signature cartridge and we've just heard some interesting rumor about mysterious new ComBloc equipment in the hands of the FMLN.

We'll keep you posted.

HOW SOF SCOOPED THE CIA

Mission accomplished. Or so it seemed. We had located AK-74 ammunition deep inside Afghanistan in May 1980 and the Afghans were willing to give us a few dozen rounds to take back to the states. All I had to do was get out of Afghanistan, return to Peshawar and find some way to smuggle the ammo into the states. There was also another item to consider. During my Afghan trek with Peter Jouvenal we had managed to obtain an NBC filter from a Soviet BMP-2. That too, had to reach the states. (In 1980 Peter used the nom de guerre "Peter James.")

For several more days we made our way toward the border by Russian truck, camel

Give a woman you care about a gift subscription

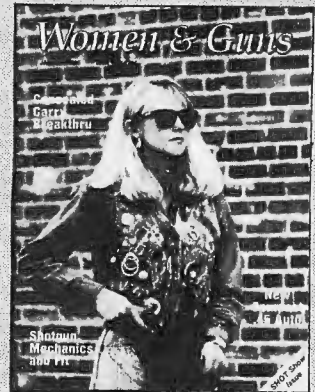

America's only gun magazine edited by and for women

You'll find it all in *Women & Guns* every month — guns, techniques, self-defense, competition, hunting, how to buy used guns, profiles and news for women gun owners. Save 40% off newsstand price.

13 issues for \$24.95

Satisfaction Guaranteed

Women & Guns

Dept. SOF, P.O. box 488, Station C
Buffalo, NY 14209

Charge Card Orders, Phone 1-800-426-4302

Free Your Hands For Vital Activities



Carry your gym or personal gear in these tough, black nylon packs. Duffle bag measures 19" by 11" with handles, shoulder strap and three zippered pockets. Fanny pack and waist pack provide you with hands-free security for your valuables.

#5005 Duffle Bag, Black, SOF logo. \$29.95

#5010 Fanny Pack, Black, SOF logo. \$24.95

#5009 Waist Pack, Black, SOF logo. \$14.95

(Add \$3 P&H 1st item, \$1 each additional item.)

Call Toll-Free to Order - VISA, MC only.

1-800-323-1776, Operator 131

Or Send your Check or Money Order to:

SOF Exchange

P.O. Box 687

Boulder, CO 80306

and on foot. After Peter and I reached Peshawar we grabbed a taxi to the American Consulate. I took two AK-74 rounds and stashed the others. I wrapped the filter in a space blanket.

Events unfolded rapidly after Peter and I passed the compound gate with the filter on my shoulder. The counsel took us into his residence. Once inside he closed the shutters, turned on the air conditioner and stereo so the Soviets couldn't hear us, then asked us what we had. I propped one foot on the filter and told him. He agreed to arrange for the filter's shipment to the United States and gave us \$100 in Pakistani rupees for dinner. We left him one AK-74 round and some other trinkets to keep him happy and insure the filter would reach the United States.

That night I sent a telegram to SOF advising Brown we had the ammo, the filter and some other items we weren't sure about. Plans were made to meet Bob Poos, then SOF editor, in Seoul, Korea, to transfer some of the rounds. Now the real trick was getting the ammo into Korea.

I took my portable typewriter apart and hid rounds in the metal works of the typewriter. I lined the sides of the suitcase with rounds and stuffed others into my camera and the toes of my boots.

From Karachi I took a Japan Airlines flight to Bangkok, picked up my baggage, checked through customs, then hired a taxi to drive me around the airport to make sure I wasn't being followed, returned to the airport. My next flight was to Seoul. The efficient South Koreans quickly found the bait AK ammo in my boots and confiscated it. They missed all the other rounds. I cleared customs, caught a cab into Seoul, checked into the hotel and waited for Poos.

That night Poos and I divided the remaining AK-74 rounds between us. The next day I caught a flight out of Korea.

In repacking my bags, before leaving Seoul, I again packed a few rounds as bait for U.S. Customs and hid the rest. Before leaving Seoul, however, the South Koreans returned the confiscated ammo to me in a sealed bag by giving the ammo to the senior flight attendant with instructions to return the ammo to me in Hawaii.

In Hawaii I stuck the half-dozen rounds the Koreans returned in my carry-on baggage. I never found out if they would clear. As soon as I hit customs a flag came up on my name and I was taken to a small room where I was patted down and my bags searched. Once again the bait worked.

As the bags were searched the customs agents shook their heads in wonder over the damage done to my typewriter by the airlines, then handed me a receipt for the AK rounds they found and confiscated. I picked up my bags, checked for the next flight to the mainland and relaxed. Most of the ammo and the cylinder would make it back with me. The filter of course was in the hands of the State Department.

When I reached the SOF office the next day I was able to drop the AK-74 ammo and other goodies on Brown's desk. He began making phone calls to the East Coast and that night Brown and I were on a plane east.

Our flight landed in Washington and we transferred to another flight to an East Coast city where we were met by government

MIL-TIME® THE SPECIALIST IN QUALITY MILITARY DESIGN WATCHES

THE AMERICAN SERIES

PRECISION WEST GERMAN QUARTZ ANALOG MOVEMENT WITH DATE DISPLAY • 12/24 HOUR MARKINGS • LUMINOUS HANDS AND HOUR INDICATORS • SOLID BRASS CASE • SHOCK AND WATER RESISTANT • STAINLESS STEEL BACK • SCRATCH RESISTANT MINERAL GLASS CRYSTAL • WATER RESISTANT LEATHER BAND • BI-DIRECTIONAL TIME RING BEZEL
LONGLIFE BATTERY • LIFETIME LIMITED WARRANTY

ACCURATE-RUGGED-HANDSOME

MODELS AVAILABLE: MARINE CORPS (SHOWN)
NAVY, AIR FORCE, 82ND AIRBORNE, 101ST AIRBORNE, 1ST CAVALRY, 7TH INFANTRY
SPECIAL FORCES ABN, RANGERS

SPECIAL OFFER
\$69.95



VISA/MC ORDER TOLL FREE
1-800-328-3227
IN CA. 415-871-6726

OR SEND CHECK/MONEY ORDER TO
MIL-TIME
456 SAN MATEO AVENUE, SUITE 1
SAN BRUNO, CA. 94066
ALL ORDERS ADD \$3.50 (CAN. \$7.00) S/H
CA. ADD \$5.07 TAX
NO EXTRA S/H TO OVERSEAS MILITARY

DISCOVER FLEX APPEAL!



Now you can develop the body you've always dreamed of having. Add inches to your chest, arms, and thighs. Sculpt your stomach, buttocks, and calves. The Body Sculptor builds muscle and relieves tension.

Adjustable electrical impulses work your muscles more effectively than regular exercise. It's medically proven, effortless, and safe!

In fact, in a recent scientific study* the technology used in our equipment was proven to be far more effective than weight lifting for training or re-educating muscles.

BODY SCULPTOR 400 BODY SCULPTOR 800:

4-Pad Unit w/ Battery
ONLY \$159 + \$5
Postage & Handling

8-Pad Unit w/ Battery
& AC Wall Adapter
ONLY \$295 + \$10
Postage & Handling



- * **Totally Portable**
- * **Used by World Class Athletes**
- * **Complete with Instructions**
- * **FREE Carrying Case**

**30-DAY
MONEY-BACK
GUARANTEE**

Try the Body Sculptor for 30 days at no risk. If you don't see amazing results, simply return the unit for a full refund, no questions asked.

*Published in Physiotherapy Canada, Vol. 3, No. 5

DAVID STEELE ENTERPRISES, INC.
64 Lehigh Aisle, Suite 400, Irvine, CA 92715

Sculptor 400 (Qty) _____ Sculptor 800 (Qty) _____

Check or Money Order Enclosed

Visa/MC # _____ Exp. Date _____

Name _____ Day Phone _____

Address _____ Apt. _____

City _____ State _____ ZIP _____

CALL TOLL FREE NOW! 1-800-428-7825, EXT. 33

Continued on page 144

YOU CAN FIND ANYONE!

Legally obtain confidential postal and DMV records; get unlisted telephone numbers; locate birth/death and credit records; obtain confidential county, state and federal court records; use the 21 secret information sources known only by professionals; search public records and files; find people who don't want to be found; locate military personnel, active and retired; and search out missing heirs; find old friends, lost children, birth parents, debtors and much, much more.

NEW AND REVISED.

8 1/2 x 11, soft-cover, 144 pages \$14.95



Send check or money order for \$14.95. Money-back guarantee. Include \$1.50 postage & handling. CA residents add 6.25% sales tax.

Send to: Books of Intrigue
11956 Bernardo Plaza Dr., Ste. 532
Rancho Bernardo, CA 92128
To order with Visa/MC call 1-800-937-9299 No C.O.D.

Please send "You Can Find Anyone"

Name _____

Address _____

City _____ State _____ Zip _____

Visa/MC No. _____

Exp. _____ Phone (____) _____

Signature _____

Ju-jo MAGNUM

MAGNUM FACTS.

World's only impact-garrote-compliance keyholder.

Weights 4 oz.,

6" long.

Hi-tech plastic

makes it

invisible to metal

detection.

Fighting handguard

protects your

hand from injury.



BIOMECHANICAL ADVANTAGES.

Increases punching force 6.8x, choking 9x, pressure uses 89x over the unaided hand.

ADAPTS TO ALL MARTIAL STYLES.

Developed by 8th degree black belt & Green Beret to improve any fighting style. Block, throw, strike, choke—Magnum does it all.

TO ORDER: Ju-jo & Manual \$21.95. Training video \$29.95. Spike-plug \$3.00. Sheath \$10.00.

TO: ParaCombatives Box 7039 Dept SOF
Evanston, IL 60201

NEW!

ALL STEEL

For **H&H**

Model 93

40 ROUNDS
CAPACITY

MP5 and Model 94

40 ROUNDS
CAPACITY

Excellent Reproduction of Original

G-3 and Model 91

30 ROUNDS
CAPACITY

Also 30 Round
Valmet M-78

30 DAY UNCONDITIONAL ONE YEAR REPAIR & REPLACEMENT

1605 W Back Dr. Phoenix, AZ 85027

TOLL FREE! 1-800-736-8018

Max/Capacity Products Inc.
Manufacturers of Magazines and Accessories for the World's Finest Firearms

ASSAULT WEAPON Owner's Manual



FN FAL

The **Fabrique Nationale FAL** or **LAR** (Light Automatic Rifle) is thought by many to be the finest weapon of its kind. This manual is for the semi-auto version as well as the select-fire model.

Details; Tech. Specs., Function of mechanism, Operating the weapon; Gas setting, Sighting, Stoppage, Grenade Launcher Cleaning & Maintenance, Disassembly/Assembly, Accessories and special sections on Heavy Barrel and Para Models. Highly illustrated with 150 detailed drawings & photos. 129 pages, quality paper, 5 1/2" x 8 1/2", includes a separate 13 1/2" x 18 1/2" 3-view cut a way drawing.

dealers inquire \$13.95 incl. shpg.



OTHER MANUALS

- HK91 SEMI & SELECT FIRE, 54 PGS., 64 ILLUSTR. \$8.00**
- HK93 (.223) SEMI & SELECT, 54 PGS., 64 ILLUSTR. \$8.00**
- ARMALITE AR180 23 PGS., 35 PHOTOS \$7.50**
- COLT AR-15A2/M-16A2, 119 PGS., 122 ILLUSTR., \$8.95**
- FULL AUTO MODIFICATION AR-15 40 PGS., \$8.00**
- KNOW YOUR M-1 GARAND 80 PGS., \$8.95**
- M14 RIFLE 50 PAGES, \$10.95**
- FULL AUTO MODIFICATION M14 RIFLE, 25 PGS., \$8.95**

SURVIVAL BOOKS

11106 Magnolia Blvd., North Hollywood, CA 91601 (818) 763-0804
Attn. Bubba, Catalog \$2.00, prices subject to change, Credit Card!
Money Order orders sent immediately, personal checks held 4 weeks.

CLASSIC MILITARY SPECIALTIES

NOT another T-Shirt!

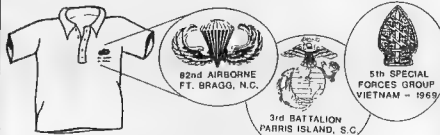

Any lettering done below emblem

Top quality custom embroidered Polo Shirts, Sweat Suits, and Lined Jackets with Airborne, Special Forces or Marine Emblem with your own lettering under it. For example, Division and Duty Station, as shown above. Each shirt, jacket or sweat suit individually crafted and **AMERICAN MADE**. Great gift idea!

- POLO SHIRT \$20.00
- SWEAT PANTS (plain) \$16.00
- LINED JACKET \$50.00
- SWEAT SHIRT \$20.00 \$23.00 (hooded)
- SWEAT PANTS (embroidered-RF thigh) \$20.00
- plus \$3.00 P&H first item \$1.00 each additional item

Please State Size: S • M • L • XL • XXL
Select Color: NAVY, RED, BLK, GRN, WHITE

PRESTIGE SHIRT CO.
P.O. BOX 7623
WARREN, OHIO 44483

Specially interesting shirts, for specially interesting people

BRIGADE SECURITY FORCES

Brochure
\$1.00 CASH!



(704) 663-6740

DEPT. SOF P.O. BOX 1237 MOORESVILLE, N.C. 28115

ANOTHER SIERRA SUPPLY EXCLUSIVE!!



The original 1969 comic book manual for rifles and troops bound for Viet Nam. Enjoy great humor while you learn all about the M-16 from the Old Sarge, Maggie the Magazine, Shorty, Connie & Sweet 16.

All classic for ex Boonie Rats, AR-15 shooters and Viet Nam memorabilia collectors.

\$5.95 or 2/\$10.00
(US residents)

foreign orders - \$7.95 per copy

SIERRA SUPPLY

PO BOX 1390 • DEPT SOF

DURANGO, CO 81302

Ring: 303-259-1822

SEND \$1.00 FOR 1990 CATALOG

ACT NOW - LIMITED SUPPLY!

TIMBERSHEPHERD®

As featured in SWAT MAGAZINE, Nov. '83,
Survival Guide Magazine, Aug '84,
American Survival Guide Magazine, Feb, '87,
Cover feature story ATLANTA WEEKLY
Atlanta Journal-Constitution Sunday
Magazine, Jan 31, 1988



Special Feature Story
SOF-Jan. '90 Issue

"THE ULTIMATE K-9"

Home & Family Protection
All Trainers Dept. of Defense Certified.
-Pups & Professional Training Available-
Lifetime Replacement Guarantee for
Genetic or Temperament Disorders.
—Excellent With Children—
Shipping Available Worldwide
"Developed and Bred Solely by"...

LRRP K-9 SERVICES, INC.

Box 1620 ME, Aiken, South Carolina 29802
Phone 24 hours: (803) 649-5936

LEGIONNAIRES SURVIVAL BOOT KNIFE

ONLY
\$12.95
Add \$1.05 Hndl.



Double edge 440 stainless steel blade.
Full tang one piece construction. Leather
sheath with quick release snap and
metal boot/belt clip. **Money Back
Guaranteed If Not Fully Satisfied!!**

WESTBURY SALES CO. DEPT. BK-10-SF
156 Post Avenue, Westbury, New York 11590

SKS 30 rd

DETACHABLE CLIP
NO CONVERSION
NEEDED

SIMPLY REMOVE THE STANDARD 10 rd MAG.
AND SNAP IN THE 30 rd CLIP

SKS 30rd CLIP **\$57.95**
add \$3.50 for shipping and handling

Send Check or M/O to:
SOS INC.
130 E. MAIN #285
MEDFORD, OR 97501
6-8 Wks. For Delivery

Fastest Service:
VISA or MASTER CARD
CALL (503)776-5309

PHOTO CARD KITS

MONEY BACK
GUARANTEE!

Our Professional quality,
laminated photo cards will
amaze your associates! We
provide the cards, plastic
laminate and easy instructions!
You provide only a
photo. Your photo Card can
be finished in the privacy of
your home! The result is a
distinctive, professional system!
The highest quality
cards in the US! Lost your
original card? Replace it
now!

only **\$4.95**

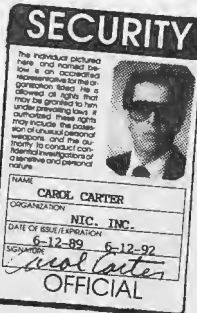

C03 Security

Select From These Kits:

- | | |
|---|---|
| C04 <input type="checkbox"/> Bounty Hunter | C06 <input type="checkbox"/> Mercenary |
| C08 <input type="checkbox"/> Special Weps. Pmt. | C41 <input type="checkbox"/> Intelligence Officer |
| C45 <input type="checkbox"/> MAC-V (CIA), #1 | C56 <input type="checkbox"/> Marine Recon |
| C60 <input type="checkbox"/> MAC-V(CIA), #2 | C46 <input type="checkbox"/> Special Forces |
| C09 <input type="checkbox"/> Suppres'd Weps. Pmt | C47 <input type="checkbox"/> Seal Team |
| C52 <input type="checkbox"/> Air America Pilot | C18 <input type="checkbox"/> Pilot |
| C01 <input type="checkbox"/> Press Card | C10 <input type="checkbox"/> Concealed Weps. |
| C50 <input type="checkbox"/> Phoenix Program | C17 <input type="checkbox"/> Int'l Drivers Permit |
| C49 <input type="checkbox"/> Delta Force | C11 <input type="checkbox"/> Private Investigator |
| C25 <input type="checkbox"/> Parachutist, Certified | C02 <input type="checkbox"/> Bodyguard |
| C26 <input type="checkbox"/> SCUBA, Certified | C12 <input type="checkbox"/> Security Consultant |
| C07 <input type="checkbox"/> Weapons Specialist | C51 <input type="checkbox"/> Special Operations |

Any
Three
Only **\$11.95**

Any
Six
Only **\$19.95**

NIC Law Enforcement Supply
220 Carroll Street Box 5210-S7
Shreveport, LA 71135-5210
24 hr. Order No. 1-318-222-2970 (FREE catalog)

Name _____
Address _____
City/State/ZIP _____
Card # _____ Exp. Date _____
VISA M/C Check M/O Fax # 318-869-3228

CLOAK & DAGGER COLLECTABLES



KGB



CIA



AIR AMERICA

- | | |
|--|--------------|
| SWEAT SHIRTS 3" Left Breast Crest |\$18.50 |
| SWEAT SHIRTS 9" Centered Crest |\$18.50 |
| HOODED SWEAT SHIRTS 3" Crest |\$24.50 |
| SWEAT PANTS 3" Crest |\$18.50 |
| T-SHIRTS 9" Centered Crest |\$8.75 |
| T-SHIRTS 3" Left Breast Crest |\$8.75 |
| TANK TOPS 9" Centered Crest |\$9.95 |
| TANK TOPS 3" Left Breast Crest |\$9.95 |
| POLO SHIRTS 3" Left Breast Crest |\$17.95 |
| SATIN JACKETS Red, White, Blue, Black |\$49.50 |
| Sizes Available on above items: S-M-L-XL | |
| BASEBALL CAPS One size fits all |\$8.25 |
| EMBROIDERED PATCHES 3" |\$5.00 |
| PRINTED PATCHES 3" |\$3.00 |
| HAT PINS Beautiful full color Hat Pins |\$4.00 |
| COFFEE MUGS (18oz.) |\$11.95 |
| BEER STEINS (23oz.) |\$14.95 |

CLOAK & DAGGER

P.O. Box 8301 Hooper, Utah 84315
Visa/Mastercard-Money Orders-Cash C.O.D.
UPS Shipping & Handling \$3.00
P.O. Box, APO, FPO, Alaska & Hawaii \$5.00
Catalog \$2.00 — FREE with order!
24 Hr. Answering Machine - (801) 399-1202

LEGENDARY ARMS, INC.

REPRODUCTION KNIVES AND SWORDS

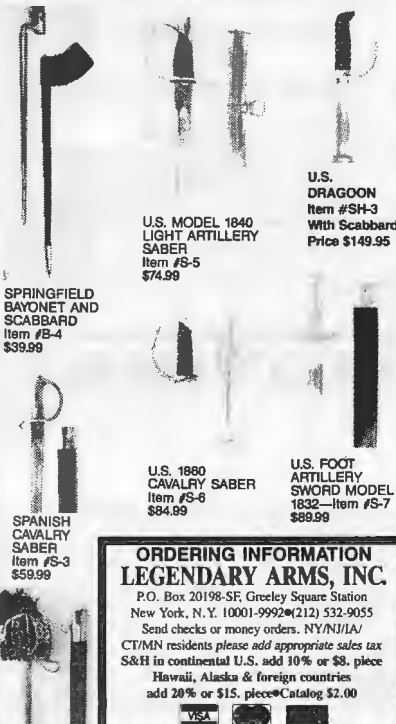

U.S. MODEL 1840
LIGHT ARTILLERY
SABER
Item #S-5
\$74.99

U.S. DRAGOON
Item #SH-3
With Scabbard
Price \$149.95

SPRINGFIELD
BAYONET AND
SCABBARD
Item #B-4
\$39.99

U.S. 1880
CAVALRY SABER
Item #S-6
\$84.99

U.S. FOOT
ARTILLERY
SWORD MODEL
1832—Item #S-7
\$89.99

SPANISH
CAVALRY
SABER
Item #S-3
\$59.99

SCOTTISH
CLAYMORE 1831
Item #SS-9
\$175.00

ORDERING INFORMATION LEGENDARY ARMS, INC.

P.O. Box 20198-SF, Greeley Square Station
New York, N.Y. 10001-9992*(212) 532-9055
Send checks or money orders. NY/NJ/IL/CA/MN residents please add appropriate sales tax
S&H in continental U.S. add 10% or \$8. piece
Hawaii, Alaska & foreign countries
add 20% or \$15. piece/Catalog \$2.00

Min. credit card order \$25
Void in States where prohibited by law
Check local laws before ordering



MISSOURI WILDERNESS CATALOGUE COMPANY

Hard To Find Military Surplus Items

- NEW MILITARY ISSUE
WOODLAND CAMO BDU's
Sizes XS-XL
Pants..... \$25.00
Shirts..... 25.00
Set Price..... 48.00



- NEW MILITARY ISSUE WOODLAND CAMO or
OD M65 FIELD JACKETS
Sizes XS-XL..... \$50.00
- NEW MILITARY ISSUE M65 FIELD
JACKET LINERS
Sizes XS-XL..... \$16.00
- NEW MILITARY ISSUE WOODLAND CAMO or
OD BOONIE HATS
Sizes 7, 7½, 7¾..... \$11.00

TO ORDER CALL: 1-800-969-8124
Mastercard and Visa Accepted
(Please include credit card expiration date)

**Send \$1 For Our Complete List of
Military Gear, Clothing & Equipment
(Redeemable with First Order)**

Satisfaction Guaranteed! Add \$3 for shipping and handling for orders under \$50.00. FREE SHIPPING & HANDLING FOR ORDERS \$50.00 & MORE. AL and HI add 15%. MO customers add 6% sales tax. Checks, money orders and cashier's checks accepted.

**MISSOURI WILDERNESS
CATALOGUE COMPANY — SOF**
2362 N. Lindbergh Blvd. - St. Louis, MO 63114
1-800-969-8124

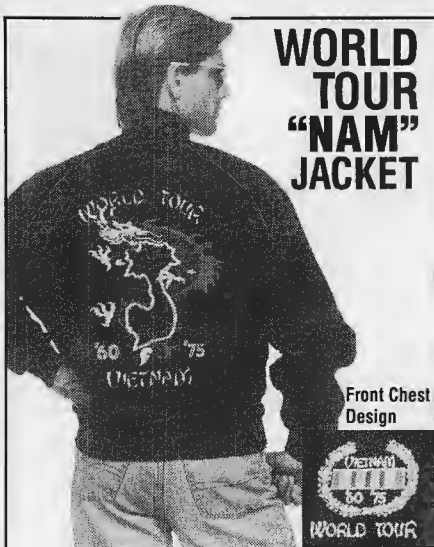

WORLD TOUR "NAM" JACKET

Front Chest Design



VIETNAM WORLD TOUR JACKET

Dedicated to the courageous men and women who have seen duty in this "hard fought" theater. Our copyrighted Vietnam World Tour Jacket has an incredible 95,000+ stitches on the back design above. The dragon of S.E. Asia surrounds and intertwines the countries of Vietnam, Cambodia & Laos in meticulous detail. The Nam Service ribbon, wreath and dates of America's longest war are intricately embroidered on the left front chest. This jacket is constructed from deluxe smooth "Celebrity" satin with contrasting piping and includes knit cuffs, waistband & collar, satin lining and zipper front. Made in the U.S.A. Sizes: S(34-36), M(38-40), L(42-44), XL(46-48), XXL(50-52).

043-33 Vietnam World Tour Jacket\$89.95

VISA Phone & Mail Orders Accepted
MasterCard Call **800-444-8643**
Discover Toll Free (For Credit Card Orders Only.)
American Express Add \$4.50 shipping and insurance charges.
 CA residents add sales tax.

Color Catalog Free With Order or Send \$3.00 To:

THE QUARTERMASTER Dept. SF1
 750 Long Beach Blvd., Long Beach, CA 90813

C.I.A. The legendary "get out of jail free cards"

Exact reprints of the covert identification cards carried by members of the CIA controlled MAC-SOG (Military Assistance Command-Special Operations Group) in Vietnam...**DO NOT DETAIN OR QUESTION HIM!** He is authorized to wear civilian clothing, carry unusual personal weapons, pass into restricted areas, requisition equipment of all types.....

CAUTION-SOLD AS WAR RELICS ONLY!

- No. C-60 Original, multi-color folding I.D. card!...\$5.00
- No. C-45 Second version of the above, issued in 1971, two color, wallet size with laminate.... \$5.00
- No. C-53 Air America Pilot's Identification Card and Pass from Siagon, Late war issue!.....\$5.00

NIC Law Enforcement Supply All
 220 Carroll - SJ, Box 5210 3 for
 Shreveport, LA. 71135-5210 \$12.00
 1-318-222-2970 (24hours) VISA/MC/MO

BULLETPROOF VEST

Will stop the .357 Magnum, 9mm and 00 Buck. Meets and exceeds "Threat Level II-A" tested in accordance with the NILECJ-STD-0101.01. Weighs 2 3/4 lbs. Fits easily under T-shirt.



Front & Back Protector. . . . \$190.00 ppd.
 Detachable Side Panels. . . . \$40.00 ppd.

Officially tested by the U.S. Government Edgewood Arsenal at the Aberdeen Proving Grounds under the U.S. Department of Justice Standards. State height, chest and waist measurements.

MATTHEWS POLICE SUPPLY CO.

(a division of David Matthews, Inc.)
 P.O. Box 1754 Dept. SF
 Matthews, N.C. 28105
 Ph. (704) 847-8793 FAX: (704) 847-4447

SOF Combat/Medicine Workshop

Sept. 11, 12, 13, 1990

Topics to include:

- Gunshot Wound Management
- Emergency Orthopedics
- Suturing/Wound Closure
- IV Therapy/Shock Management
- Patient Evaluation
- Mass Casualty Practical

Internationally Recognized Faculty

Registration Deadline:
 9/1/90

Space Extremely Limited

For information write:
Rick Devenney, SOF/CMW
 5093 Cothrin Ranch Road
 Shingle Springs, CA 95682
 FAX (916) 638-3002

PRIVACY ?

Avoid BIG BROTHER.
Best techniques for creating COMPLETE PRIVACY!

- Avoid Surveillance, Eavesdropping
- Become "Invisible" to Investigators
- Stop Generating Financial Records
- Communications Privacy . . . Phone, Mail
- How to Stay Out of Government Files
- Begin Eliminating Negative Records
- How to Create Helpful New Records
- Generating Quick Cash Income
- Hiding Your Assets ■ Privacy Afloat
- Banking Alternatives ■ "Low Profile"
- Privacy from Taxes ■ Nomadic Living
- Multiple Addresses
- Hideouts, Deep Cover
- How to "Disappear"

ALL THE PRIVACY YOU WANT — and MORE!
 Don't wait! Order TODAY!!

ONLY \$18.95



EDEN PRESS
 11623 Slater "C", Box 8410-AP, Fountain Valley, CA 92728
 Your Choice Regular P&H, \$2.00 (Please add
 FIRST CLASS, \$5.00 to order.)
 (California residents please add 6% sales tax.)
 Send latest Book Catalog — FREE.

Name _____
 Address _____
 City _____
 State _____ Zip _____

MOVING?

PLACE LABEL HERE

PR / MS _____
 Street _____ Apt. No. _____
 City / State / Zip _____
 Mail it to: **SOLDIER OF FORTUNE Magazine,**
 P.O. Box 348, Mt. Morris, IL 61054

REGA 3, INC.



8930 W. State Road 84
 Suite 315
 Davie, FL 33324
 Telephone (305) 472-0472

UNIQUE AND IMPRESSIVE

The emblems of U.S. Armed Forces and Elite Units elegantly embroidered directly onto high quality polo shirts, sweats and jackets. Participate in color selection of not only the item, but the insignia itself. Turn color into subdued. It's your choice. Send for brochure/price list. Custom design work available for unit orders. Perfect for reunions. Write or call today!

SPECIAL EDITION: OPERATION JUST CAUSE

THE HOUND DOG

Sniffs Out Hidden Transmitters

Throughout the world today, corporations, professional men, and businessmen are spending millions annually to insure privacy in their offices and homes where important plans and policy making decisions are discussed and formulated. The "HOUND DOG" is a wise investment for anyone who has reason to believe that an eavesdropping device is now hidden, or may be hidden in the future, in either home or office. No radio transmitter, no matter how well it may have been hidden, can escape detection by the "HOUND DOG".

The "HOUND DOG" is an advanced electronic instrument designed for the sole purpose of locating hidden transmitters. An average size office or room can be thoroughly searched in only a matter of minutes. The "HOUND DOG" sniffs out any transmitters hidden in pictures, walls, desks, chairs, etc., regardless of their operating frequency.

The "HOUND DOG" is simple to use. Single knob adjustment calibrates the meter and any transmitter signal received is indicated by the meter movement. By simply sweeping the probe past walls, chairs, pictures, desks, etc. the presence of any transmitter will cause a rise in the meter reading. The meter reading will continue to rise as the probe approaches the transmitter.

We believe you will find the "HOUND DOG" outperforms most other units selling for several times the price. This item has been built since 1962. Each one is backed by a 3-year warranty by us.

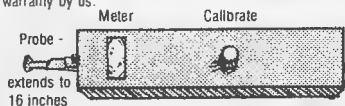

SIZE... 1.6 x 2.4 x 8.2 INCHES **\$195.00**
USES A COMMON RADIO BATTERY

Super Powerful FM TRANSMITTER

Many times more powerful than other transmitters. Transmits up to 1/4 mile to any FM radio - Easy to Assemble Kit - up to 9V battery (not incl.)

\$19.95

Call 407-725-1000 or send \$195.00 plus \$5.00 shipping for Hound Dog and \$19.95 and \$1.00 shipping for FM Transmitter to USI Corp. P.O. Box SF-2052, Melbourne, FL 32902. COD's OK. For a catalog of transmitters, voice scramblers & other specialty items enclose \$2.00 to USI Corp.

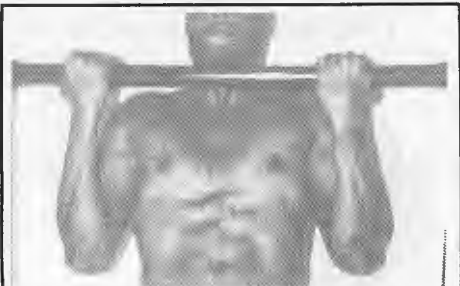

YOU CAN NOW DO PULL-UPS ANYWHERE CONVENIENTLY with a self supporting pull-up bar. Strong sturdy design. Build it yourself and save! No special tools or welding required. An easy to follow step by step plan guides you through 27 illustrated steps using pvc plastic pipe and other common materials for under \$120 total cost to make. Send \$6 for (27p.) booklet (*Nev. Residents add 6% sales tax*) to:

The EXerciser

316 E. Bridger Ave Dept. 339 , Las Vegas NV. 89101.

THE HUNTER & THE HUNTED

FINALLY, the secrets of the **BOUNTY HUNTER!** Written by a **BOUNTY HUNTER!** Learn how to find anybody or anything by reading actual case histories and the step by step text of how to **FIND PEOPLE WHO DON'T WANT TO BE FOUND.**

The **BEST SELLER** on the art of earning your living by **HUNTING PEOPLE FOR BOUNTY.** No blown out of proportion exaggerations, no phony fiction. This book is not for **WANNABES** or **MOVIE BUFFS!** This is the **REAL LIFE** text used by professionals worldwide, now available to you. Updated annually to let you in on the latest secrets and techniques! Get yours now by sending \$18.95 in cash, cashier's check or money order only to:

Leeward Press
P.O. box 230362
Portland, OR 97223

VIETNAM — OUR GENERATION'S WAR

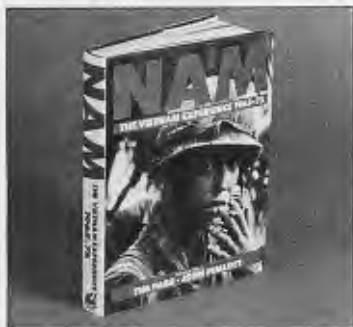

From the first Marines to the fall of Saigon, **NAM** brings you the triumph and defeat of America's longest war. With eyewitness accounts, unrivaled photos and graphics, weapons and tactics profiles, and searching analyses of the war's development from both sides of the DMZ, **NAM** is the finest documentary of the war you'll ever read.

9 x 12, hardcover, 650 pps. 100s of photos.
#8040 Nam \$39.95 (Add \$3.00 P&H)
Call Toll-Free to Order VISA/MC or C.O.D.
1-800-323-1776, Operator 131
Or Send Check or Money Order to:
SOF Exchange Dept. 10/90
P.O. Box 687
Boulder, CO 80306

JIMMY LILE

"The Arkansas Knifemith"

"Imitated but unequal"



Designer & Maker of the survival knives for the movies, "First Blood" & "Rambo"

2721 So. Arkansas Ave.,
Russellville, AR 72801 (501) 968-2011

THE ADVENTURE CONTINUES...

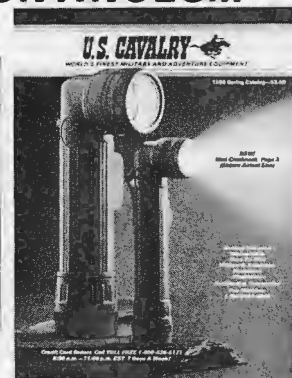

Over 100 pages of high quality and functional gear: genuine military clothing and equipment for outdoors, survival and the streets. Send \$3.00 for copy of our full color catalog.

Name: _____
Address: _____
City: _____
State: _____ Zip: _____

Mail This Ad To:

U.S. CAVALRY

WORLD'S FINEST MILITARY AND ADVENTURE EQUIPMENT

DEPT. SF-10

2855 Centennial Ave., Radcliff, KY 40160-9000

GUN PARTS CORPORATION

SUCCESSORS TO NUMBICH ARMS
THE WORLD'S LARGEST GUN PARTS SUPPLIERS
PRESENTS ITS NEW #15 CATALOG

Featuring an inventory of over 350 million gun parts in house. A 500+ page catalog with exploded drawings that are invaluable to the gunsmith or hobbyist. **Commercial, military, antique and foreign** gun parts (many exclusively available from us) are listed and priced along with accessories, surplus & specialty items. A veritable encyclopedia of gun parts, this catalog will pay for itself time and time again with information and time saved in identifying parts.

SURFACE FOREIGN - \$10.95 U.S. \$5.95
AIRMAIL WRITE FOR QUOTE send

GUN PARTS CORP. BOX SOF-10 W. HURLEY, NY 12491
914-679-2417 TELEX 145 331 FAX 914 679 5849

FLY THE FLAGS

Tell The World You Served!



Size 3' x 5' with Grommets
Made of Cotton and Polyester
Indoor or Outdoor Use

only \$12.95 Each Two for \$23.00

Select From

- | | |
|--|--|
| <input type="checkbox"/> U.S.A. | <input type="checkbox"/> AIR BORNE |
| <input type="checkbox"/> VIETNAM VETERAN | <input type="checkbox"/> 1ST. CAVALRY |
| <input type="checkbox"/> ARMY | <input type="checkbox"/> KILL EM ALL LET |
| <input type="checkbox"/> P.O.W./M.I.A. | <input type="checkbox"/> GOD SORT EM OUT |
| <input type="checkbox"/> U.S.M.C. BULL DOG | <input type="checkbox"/> SKULL & BONES |
| <input type="checkbox"/> NAZI (WWII) | <input type="checkbox"/> CONFEDERATE |
| <input type="checkbox"/> ARMY | <input type="checkbox"/> MESS W/THE BEST |
| <input type="checkbox"/> NAVY | <input type="checkbox"/> DIE LIKE THE REST |
| <input type="checkbox"/> AIR FORCE | <input type="checkbox"/> AMERICA LOVE IT |
| <input type="checkbox"/> MARINES | <input type="checkbox"/> OR LEAVE |
| <input type="checkbox"/> COAST GARD | <input type="checkbox"/> SPECIAL FORCE'S |

IDEAL STUDIOS

P.O. Box 41156 • Chicago, IL 60641

Plus \$2.00 Shipping & Handling. For prompt delivery send cash, cashier's check or money order.

Name _____

Address _____

City, State, Zip _____

Viet Nam Veteran Owned

FIREARMS GRAPHICS

WEAPONS LOGOS in FULL COLOR

Machine Embroidered. (No Iron-On Crap!)

- Shooter's Caps \$12.95
- Decals \$9.95
- Patches \$9.95
- Polo Shirts \$24.95



Sturm, Ruger (Shown)
Smith & Wesson
Beretta
Colt

(Dealers Inquires Invited)

Specify LOGO, Item (Cap, Shirt, etc.), Size, Color.
Send Check or Money Order (Allow 5 weeks):

FIREARMS Graphics

Box 791

Norton, MA 02766

SPECIAL OPS. T-SHIRT



"US Army, Winning Hearts and Minds"

Sizes: S-M-L-XL Black with Silver

Only \$9.95 each Add \$2 Shipping & Handling

Send Check or Money Orders to:

CAPT. HUMBLE INDUSTRIES

P.O. Box 15756, Long Beach, CA 90815

TUNDRA SHEPHERDS



Perfect Night Vision, 1,000 lbs. Jaw Pressure, 1,000 lbs. Knockdown power, Ultra Keen Perception. The Ultimate Sentry & Loyal Companion. Top Quality German Shepherd Import Bloodlines. Alaskan Tundra Wolf —World's Largest Strain. Solid Blacks for Invisible Night Duty. Unconditional Guarantee on Genetic Defects. USDA licensed & inspected. Worldwide Shipping; Pups or Adults. 6 color photos \$2.

WKE Ltd.

Rt. 1 Box 94

Chebanse, IL 60922

(815) 697-2678

LEARN LOCKSMITHING!

Become a Master Locksmith

Secure your financial future

Learn at home

Be Your Own Boss!

Basic Locksmith I Course:



INCLUDES:

- Video (VHS)
- How to Pick Locks
- Professional Lock Picks
- ID Card
- Certificate
- 12 Course Catalog

Earn up to \$48.50 per hr., full-time or part-time. Be a master locksmith after completing our 12 course education program. Each course has its own video, tools, supplies, instruction, and certificate. After only 1 course, be able to open locked homes, offices, and autos for paid fees! Train further about locks, autos, safes, etc.

SEND TODAY! \$79.50 + 2.50 handling
(\$82.00 Check, Money Order, US Funds Only)

OR

Without Video (Same course with written instructions, professional picks. Same as above with ID Card, Certificate, Catalog)
\$49.50 + 2.50 handling (\$52.00 Check, Money Order, US Funds Only)

Send \$82.00 or \$52.00 To...

AMERICAN LOCKSMITH SCHOOL

2100 Roswell Rd., Suite 200C-223
Marietta, GA 30062

The Big Ones!

Now this is a knife...



Special Sale!
Both for \$39.95

Beautiful rosewood handles and brass handguards.
Giant Bowie Authentic style modeled with the original in mind. 14-3/4" overall with an unbelievable 10-1/4" heavy gauge carbon steel blade. Leather sheath. \$22.50
Arkansas Toothpick Nobody will pick a bone with this. The biggest toothpick knife we have ever seen. 18" overall. 12-1/4" double-edged blade. Leather sheath. \$22.50
Send check or money order for immediate shipment! Add \$3.00 for shipping. Ill. residents add 7% tax. Visa/MC call Toll-Free 1-800-843-4105. In Illinois 1-800-225-2501.

Money back guarantee if not pleased!
Ballard Cutlery Dept. SF-10
1495 Brummel Ave., Elk Grove, IL 60007

AFFORDABLE LEGENDS...

THAT ANYONE CAN OWN.

See your local dealer or send \$2.00 for color catalog.



We're proud to present our semi-automatic .45 caliber legends.

Auto-Ordnance Corporation

BOX SF-10, West Hurley, NY 12491 (914) 679-7225



SUPPORT AFGHAN FREEDOM FIGHTERS GIVE THEM THE TOOLS TO FINISH THE JOB.

The Afghans have driven the Soviet Army from their country, but the war's not over; they still have to get rid of the Communist puppet government.

SOF's AFGHAN FREEDOM FIGHTERS FUND has raised and spent over \$150,000 for things like tactical radios, mine detectors and various special projects; the need is as great as ever. We need to send them the tools to finish the job.

Send your donation to:
AFGHAN FREEDOM FIGHTERS FUND
P.O. Box 693
Boulder, Colorado 80306

None of the funds collected go to staff salaries or administrative expenses. Donations are *NOT* tax deductible, and for that reason all the more appreciated.

CLASSIFIED

CURRENT REQUIREMENTS — \$2.00 per word per insertion — \$40.00 minimum. All adds **MUST BE PREPAID**. Ad copy must be typed or written clearly with authorizing signature, a telephone number (for our files) and full payment. Advertisers offering information packets for a fee must send sample of packet (packets will not be returned). Name, address and telephone number are to be included in your word count. **EXAMPLE:** P.O. Box 693 = 2 words; 80306 = 1 word. Abbreviations such as DI, SGT, 20mm, U.S. count as one word each. Hyphenated words and telephone numbers are counted as two words. No personal services ads accepted. We reserve the right to refuse, delete or change any copy which we determine to be objectionable. Mail classified ads with payment to **SOLDIER OF FORTUNE, Classified Dept., P.O. Box 693, Boulder, CO 80306.**

READERS OF BOTH DISPLAY AND CLASSIFIED ADVERTISING ARE ADVISED THAT SOLDIER OF FORTUNE MAGAZINE DOES NOT VERIFY VALIDITY OF EVERY ADVERTISEMENT AND/OR THE LEGALITY OF EVERY PRODUCT CONTAINED HEREIN. SHOULD ANY READER HAVE A PROBLEM WITH PRODUCTS OR SERVICES OFFERED BY AN ADVERTISER, HE SHOULD SEEK ASSISTANCE FROM HIS NEAREST POSTAL INSPECTOR AND ALSO CONTACT OUR ADVERTISING DEPARTMENT. SOLDIER OF FORTUNE DOES NOT INTEND FOR ANY PRODUCT OR SERVICE ADVERTISED TO BE USED IN ANY ILLEGAL MANNER.

NOTICE TO READERS
SOLDIER OF FORTUNE Magazine is a magazine of national and international distribution. There may be products for which sale, possession or interstate transportation may be restricted, prohibited or subject to special licensing requirements in your state. Purchasers should consult the local law enforcement authorities in their area.

APPAREL

MY MAN IS A SKY SOLDIER. Ladies bikini panties. Indicate size (5,6,7,8) and choice of Jump Wings, Air Assault Wings or Glider Wings. \$9.75 ppd; Ranger Andy-SOF, PO Box 7682, The Woodlands, TX 77387-7682. (156)

INTERNATIONAL CAMOUFLAGE & EQUIPMENT. Updated Fall 1990 Catalog of Camouflage Uniforms, Headgear & Equipment from over 30 Countries! Catalog \$1.00. A.H.A., Box 21606, Denver, CO 80221. (156)

FRENCH MILITARY "LIZARD" CAMOUFLAGE. Current Issue F-1 Suits, Unissued Jacket & Trousers \$68.00, Caps \$16.00, Swim Shorts \$12.00. A.H.A. Box 21606, Denver, CO 80221 MasterCard & VISA Accepted! (156)

BOOKS•PUBLICATIONS

DIVORCE DIRTY TRICKS. Protect property. Win custody. Sharpest tactics revealed. 228 page book \$16.95. Visa/MC accepted. EDEN Press, Box 8410-DD Fountain Valley, CA 92728. (160)

INTERNATIONAL INVESTIGATORS' NEWSLETTER: Two issues \$2.00. Licensing Guidebook (PI's, FFL's weapons) \$14.95. Police Badge Catalog \$1.00. Eagle, (S)Box 6303, Corpus Christi, TX 78466. (158)

WHO KILLED KENNEDY? Assassination research materials. Videocassettes, photographs, literature, Zapruder film. Catalogue: \$3. Collector's Archives; Box 2 Beaconsfield, Quebec. H9W 5T6. (164)

FREEDOM OF INFORMATION act. Find out what the government knows about you or anyone else; for forms and instructions send \$4.00 ck/mo to: Center of Public Information, PO Box 11588, Fort Worth, TX 76110. (156)

WORLD INTEL REPORT. Super source for hard data, mailed twice/month. Sample US \$2.00, one year US \$19.95. PO Box 1265, Merchantville, NJ 08109. (156)

PRIVATE EYE, ADVENTURE FANS: Experience P.I. Magazine. Real cases, fiction, reviews, more. Quarterly \$10/year. 755 Bronx, Toledo, OH 43609. (156)

Men & Women! Make **BIG** Money!! Be a...

PRIVATE INVESTIGATOR

"Clue" into big profits, excitement, intrigue and adventure with your own P.I. business! \$100,000 a year or more made as your own boss! Amazing one-of-a-kind business home-study course tells all! Train to be part of the fastest growing profession in the country. Quickly learn:

- ★ How to get on the "fast track" to big money
- ★ All fundamentals of private investigation and surveillance
- ★ How to start your own detective agency
- ★ Where to buy state-of-the-art electronic detection equipment
- ★ How to operate from home, no investment required
- ★ ID Card & Diploma awarded!

Free Information:

UNITED STATES ACADEMY OF
 PRIVATE INVESTIGATION
 DEPT. INVESTIGATIONS (SF)
 BEVERLY HILLS, CA 90213

CABLE-TV BOXES

Descramblers • Converters
FREE CATALOG

TRANS-WORLD CABLE CO.
 12062 Southwest 117th Ct., Suite 126
 Miami, Florida 33186
 800-442-9333

MILITARY COLLECTORS

postpaid. • German War Badges • postpaid.

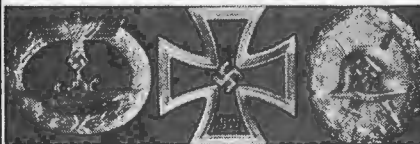

Sub — Iron Cross — Wound

Your choice any one = \$8.00 or all 3 = \$20.00. All are full size, not miniatures. These made from originals. Your choice W.W. #1 or #2 (state choice). We have most complete stock of W.W. #2 German badges-caps-flags, etc. in U.S. **OVER 40,000 ITEMS IN STOCK.**

Postpaid. (Sent free with any order).
 Our 224 page fully illustrated CATALOG - \$5.00.
W.W. #2 Ltd. Box 2063-F, St. Louis, Mo. 63158

357 MAGNUM Bullet Keychain



ACTUAL HOLLOWPOINT ROUND!

Safe. Cannot be fired. Great gift idea. ONLY \$4.95 or SAVE and get two for JUST \$8.95. Add \$ht of \$1.30 for one or \$1.80 for two.

MAGNUM PRODUCTS

Dept. 100 Box 111084, Aurora, CO 80042
 CO residents add 3% sales tax. Denver add 7.3%.
 Delivered within 60 days.

NEW BOOK CATALOG! 50 page catalog describes over 300 fascinating titles. The best non-fiction books available for men of action and adventure! Send \$1.00 to: Paladin Press, PO Box 1307-DGQT, Boulder, CO 80306. (158)

UNARMED COMBAT! Be your own bodyguard. Practical self-defense. Illustrated book \$13.00. Libra Enterprises, Box 31719-SF, San Francisco, CA 94131. (156)

THE ANARCHIST COOKBOOK is now available again! Complete, uncensored edition. Send \$22 to Barricade Books, PO Box 1401-Z, Secaucus, NJ 07096. (167)

HANDSOME GIFT TITLES RECALLED, by Fred Farris. OSS World War II, Korea, Special Investigation. 83 tales, witty and shocking, to read aloud to your friends. You'll wish you had known Fred Maybe you did. He died of cancer at 61. Non-profit, 196 pages, \$16.25. H. Copeland, 1850 Maryland Avenue, Charlotte, NC 28209. (156)

LIGHT WEIGHT ARMOR HANDBOOK. Complete guide on designing and fabricating personal and vehicle armor. Features latest materials: Kevlar, glass and ceramics. Includes sources of supply. 120 pages only \$18.50, post paid. A.C.T., PO Box 24722, Baltimore, MD 21220. (156)

ENCLOPEDIA OF REVENGE — The most devastating manual ever published! Over 1000 entries, completely cross referenced. It would take 15 books to equal the information jam-packed in this giant 8 1/2"x11 hardcover volume. \$49.95 plus \$3.50 shipping/handling to Anchor Publishing, PO Box 2630-P, Landover Hills, MD 20784. Visa/Mastercard orders call 24 hours. (800)448-8280. (156)

ELECTRONIC SURVEILLANCE. Complete construction plans from the worlds most acclaimed designer of electronic spy equipment. Free Catalog. Wilson, PO Box 5264, Augusta, GA 30906. (161)



SpS
SPECIALIZED PROTECTIVE SERVICES INTERNATIONAL™

DEDICATED TO THE HIGHEST STANDARDS

SERVICES INCLUDE:

- EXECUTIVE & CELEBRITY PROTECTION
- INDUSTRIAL SECURITY
- SPECIAL INCIDENT RESPONSE TEAMS
- DOMESTIC & FOREIGN SERVICES

TRAINING COURSES INCLUDE:

- EXECUTIVE PROTECTION
- RISK ANALYSIS
- AIRCRAFT & YACHT SECURITY
- EVASIVE DRIVING
- SECURITY PLANNING

P.O. Box 25261
 Colorado Springs, CO 80936
(719) 520-9025

 —COURSES—
 ☆ COMMANDO - 7 DAYS
 ☆ SURVIVAL - 5 DAYS
 ☆ SNIPER - 5 DAYS
 ☆ SAS - 30 DAYS

\$1.00 CASH FOR A BROCHURE

BRIGADE SECURITY FORCES
 P.O. BOX 1237 DEPT. SOF
 MOORESVILLE, NC 28115 USA

NEWMAN'S G I SUPPLY

R.D. #10 BOX 10419, NEWTON, NEW JERSEY 07860

Send \$2.00 For 200 Item Catalog! **WE PAY SHIPPING**

COMBAT ASSAULT VEST
 Woodland Camo
\$89.00



5.56mm/7.62mm/9mm SMG

6 large pockets hold 12 30 rd 5.56 mm magazines, 12 7.62mm or 12 9mm SMG; 2 chest accessory pockets; 2 large inside pockets hold 12 more magazines, knife, pistol, etc. Attaching points on back for Alice Gear Duck release buckles. One size fits all.

ORDERING INSTRUCTIONS: Money Order, personal checks or Visa & MasterCard gladly accepted. NO COD's. All merchandise is 100% guaranteed. Residents of Alaska, Hawaii and Puerto Rico add 5% for shipping.

(201)948-8280

BUG ROOM THRU PHONE

You add a circuit inside a phone. It still works the same as it always did (sends and receives calls normally) except when **ONLY YOU** call that phone and send special code - it doesn't ring - yet answers itself allowing you to listen in on room while its still on the hook! Now we are perfected! Call from anywhere at any time to listen in! Uniquely designed to work with the most popular phones. Easy to use and works great. Step by step instructions how to build & install. Send \$9.95 to: Laser Bounce, Inc. 2020 Pennsylvania Ave. NW Suite 802 Washington, D.C. 20006

THE JOY OF REVENGE. Ms. Nastly's unique get even book, \$4.98. MBC, Box 2264E8, Peoria, AZ 85345. (156)

SURVIVAL ON THE BATTLEFIELD: A handbook to Military Arts. A complete training program manual with most effective personal combat techniques yet. \$12.50 postpaid. UFD, Dept. SOF, 410 Delaware, Leavenworth, KS 66048. (156)

SURVIVING HOSTAGE SITUATIONS manual. Written for families, this book receiving rave reviews from the professionals. \$16.50 postpaid. UFD, Dept. SOF, 410 Delaware, Leavenworth, KS 66048. (156)

BUSINESS OPPORTUNITIES

LEARN GOLD, SILVER, PLATINUM SCRAP RECYCLING business. \$75,000 year possible. Spare time. Free information: Recycling, Box 11216SF, Reno, NV 89510-1216. (156)

LET THE GOVERNMENT FINANCE your new or existing small business. Grants/loans to \$500,000. Free recorded message: 707-449-8600. (KW5) (156)

MILITARY MEDALS
WORLD WAR II * KOREA * VIETNAM

Full Size U.S. and Vietnamese Medals, Badges, Fine Display Cases, Ribbons, Miniature Medals. Display the valuable Medals awarded you or your family,
Personal Service..... Full Guarantee
Write Today!..... FREE CATALOG
MEDALS, 1929S1 FAIRVIEW RD
FOUNTAIN INN, SC 29644

HAT PINS - PATCHES - FLAGS
600+ MILITARY DESIGNS
FREE 24 Page ILLUS. CATALOG
WE DO CUSTOM WORK
Dealer Inquires Welcome
HOOVER'S MFG. CO.
4015F PROGRESS BLVD.
PERU, IL 61354
(815) 223-1159, Ask For David

CHINA BITCH
Beautiful Color
Photos of
Women BAREing
Military Weapons

Send \$10 for
3 color photos &
pricelist
also available
8x10 Color Prints
personally autographed
with your name & message
by one of the women of
CHINA BITCH

Send check or money order
G & J 39120 Argonaut Way
342 Fremont CA 94538

INTERNATIONAL COMBAT TRAINING

TAKE THE INITIATIVE - Invest in an Exciting and High Paying Career. Brigade is a Complete International Small Arms and Elite Forces Training Facility.

BRIGADE SECURITY FORCES
P. O. BOX 1237, DEPT. SOF
MOORESVILLE, NC 28115 USA
CATALOG \$3.00 PHONE (704) 663-6740

OPEN A BLOCK WATCH. Non-profit. Simple business plan. 40 pages. Send \$24.95 to U.S.A., Box 9722, Denver, CO 80209. (156)

COLLECTORS
BRITISH/SCOTISH MILITARIA COLLECTORS. Regimental insignia; blazer crests; ties; wall plaques; tankards; berets; belts; swagger canes; cassette; videos; etc; of elite British/Scottish Regiments, including SAS, Paratroops, Marines, Guards, Black Watch, RAF, RN, etc. Import Catalog \$3. BRITISH REGALIA IMPORTS, DEPT. 6, P.O. BOX 50473, NASHVILLE, TN 37205. (157)

AMAZING NINJA FLING: Oldest lethal weapons known to man. Operational unit mounted on beautiful hardwood base, with instructions. Legal in most jurisdictions. \$14.99 each. Ram's Head, PO Box 690671, Tulsa, OK 74169. (156)

BRITISH MILITARY SUPPLY, America's Largest Supplier of Genuine Current Issue British Gear, List & Color Photo \$1.00, B.M.S., Box 21606, Denver, CO 80221. (156)

MILITARY MEDALS CATALOGUE \$1. Yearly subscription \$8. S. Vernon, Box 1450SF, Wildomar, CA 92395. (156)

U.N. BLUE BERETS, Issued for Peacekeepers/Observers Complete with Large Gold & Enamel U.N. Badge \$28.00. A.H.A., Box 21606, Denver, CO 80221. (156)

WW11 RELICS! Cheaper than certain "well-known" relic dealers! We beat their prices for flags, daggers, medals, insignia, helmets. Illustrated catalog \$5. (refundable). RELICS, Box 261-D, Cambridge, MN 55008. (157)

VIETNAM Collector? Patches, books, DI pins T-shirts. Catalog \$1. SATCONG, Box 177VF, Syracuse, NY 13208. (165)

WWII WAR SOUVENIRS! Includes daggers, swords, helmets, everything! Illustrated catalog \$15. (refundable) NO CHECKS. Disco, Box 331-X Cedarburg WI 53012. (156)

WW2 GERMAN MILITARIA: Insignia, flags, medals, uniforms, T-shirts, posters, camouflage. World's biggest catalog, \$2.00. Krupper, Box 177SF, Syracuse, NY 13208 (165)

RHODESIAN AND SOUTH AFRICAN BADGES Medals and uniforms for sale. For a list send \$1 to Kaplans, Box 890638, Lyndhurst 2106 South Africa. (156)

CAMOUFLAGE AND MILITARIA. Over 32 countries. New Fall illustrated 24 page catalog. \$2.00. World Militaria, PO Box 450902, Garland, TX 75045-0902. (156)

EDUCATION
TERMPAPER assistance. 16,278 topics available! 306-page catalog —rush \$2.00. Research, 11322 Idaho, #206EX, Los Angeles, CA 90025.
TOLL FREE HOTLINE: 800-351-0222 (California: 213-477-8226) (167)

EMPLOYMENT
OVERSEAS, STATESIDE. \$100 to \$1000 daily. Now hiring. FREE list. ZINCS 117, Box 13110, Las Vegas, NV 89112. (158)

BLACKHAWK CROSSBOWS, INC. BOX 27222 Salt Lake City, UT 84127

150 lb. Crossbow, limited heat-treated suspension fiberglass bow, Fiberite® glass stock, die-cast alloy nose, front/rear Steel micro-adj. sites, wind/elev. failsafe trigger, safety, brass track, akri grips, Monte Carlo cheekpiece, scope mount, 15' draw, model and 110 lbs 225 lbs

150 LB. DRAW SCOPE EXTRA \$199.95
2 FOR \$79.95
ADD \$8.90
AUS. EA.

16" Hunting Broadhead \$59.99 \$35.75
16" Target points \$39.99 \$23.75
4x20 (5m) \$39 \$22.22
6x32 (10) \$89 \$44.44
Eastern Alum. arrows per Doz
CROSSBOW SCOPES
Nikka®
4x20 (5m) \$39 \$22.22
6x32 (10) \$89 \$44.44
Eastern Alum. arrows per Doz

ORDER NOW! WE'LL SHIP TODAY
CALL 800-228-2423 or 801-975-0222

JOBS, Any state, any occupation, including government, state, public. Also cruiseships, tugs, ships, riverboats, oilrigs, women-men. Work month-home month. USA plus overseas. Information \$5.00. Nationwide Employment, B242, Cental, IN 47110. (156)

INTERESTING CAREER LISTINGS: Police, Security, Investigation, Intelligence. Nationwide, some international. Executives to \$80,700. Positions explained. 3 monthly issues: \$16.95. PSIC/FO, PO Box 1562, Decatur, IL 62525. (156)

KOREA JOBS: Most professions/callings. Over 800 current listings! \$29.95 (check or money order): Army Haddon, 212 Waegwan 1-Dong, Chilkok-Gun, Kyong Puk, 719-800, South Korea. (158)

FEDERAL LAW ENFORCEMENT GUIDE information on over 25 Federal Agent/Officer positions: Job descriptions, qualifications, application procedures, salaries and more. \$7.00. FLE Guide, PO Box 1622, Springfield, IL 62705-1622. (157)

FIREARMS • ACCESSORIES
SPORTING AND MILITARY RIFLES, pistols and ammunition. 20-50% below retail. Why pay more? Catalog \$2 refunded with first order. MK2 Company, Dept. SOF, PO Box 462367, Garland, TX 75046. (166)

GALLI MAGAZINES Reliable, inexpensive 20 round magazines, caliber .308. \$26 each postpaid, Survival Products, Box 582F, Emigrant, MT 59027. 406/333-4567. (156)

FOR SALE
VIETNAM T-SHIRTS combat art without apology. Beaucoup patches, pins, videos, and more. Catalog \$2, SLP, 1105 N. Main Street, 2A, Gainesville, FL 32601. (158)

HAIR REGROWTH 4 MONTHS! New potent formula cures baldness. Prevent hereditary baldness. Halts receding hairline. Box 1213-S, Makati 1299, Philippines. (167)

CHICOM AK 47 STYLE AIR RIFLE — \$79.95. Gun and Knife List —\$1.00. M. Craig Trading Co., PO Box 1994, Rocklin, CA 95677. (156)

VIET CONG SANDALS. Like Charlie wore. For custom pair, draw imprint of foot on paper. Send along with \$25.00 to: Charlie Company, PO Box 2185, Lancaster, SC 29720. (156)

CONFIDENTIAL CATALOG of police and investigation equipment. \$2. IPEC, Dept. SF-156, Box 7638, Sunnymead, CA 92303. (164)

WORLD WAR TWO PHOTO'S. Exclusive photo's from private collection of WWII disabled vet. 33 in all. Details about each photo. Send \$19.50 to PHOTO'S, PO Box 151, Stanton, AL 36790. (157)

TEARGAS used by FBI and major police departments. Strongest on market \$14.95/20 shot, \$24.95/60 shot. Mehalick, 3839 Dawson Street, Pittsburg, PA 15213. (156)

CIA EXCLUSIVE! 19mm coin casings complete with Central Intelligence Agency Seal. \$5/pk. Orders of 10 or more \$3/pk. CV Wesley, PO Box 1976, Crestview, FL 32536. (156)

YOU'LL LOOK SHARP with genuine GI dogtags! Your information or any wording is only \$6.95 per set. Great gift for teens! VISA, M/C or inquiries call 1-800-669-7210. (157)

SPYER RECORDER "SUPERLONG" — plays 5 hours on single LP cassette \$59.95; telephone adapter \$19.95; LP cassettes \$4.95 ea. "Stunguns" — 65,000 volt \$39.95; 90,000 volt \$69.95; 50,000 volt with built-in screeching alarm + burglar + fire alarm attachment \$79.95; emergency hand-held alarm with anti-purse snatch attachment \$29.95. "Portable motion detector \$15.80. Shipping \$4.00. TTC-F, Box 160337, 11000 104st., Miami, FL 33116. (156)

UNUSUAL BOOKS
OVER 900 TITLES—ALL AT DISCOUNT PRICES!
MANY AVAILABLE NOWHERE ELSE
PRIVACY • UNDERGROUND BUSINESS • NEW IDENTITY
BLACK MARKET • LEGAL SELF-HELP • SURVEILLANCE
SURVIVAL • DISGUISE • CRIME • REVENGE • CHEMISTRY
EXOTIC WEAPONS • FIREWORKS • LOCATING PERSONS
PLUS MANY OTHER CONTROVERSIAL SUBJECTS-DISCOUNTED!
HUGE 112 PAGE DISCOUNT CATALOG—\$1 (Ref.)
ANVIL • Box 640383F • El Paso, TX 79904

STEALTH HIDEOUT ESCAPE SAW

A nonweapon that can go anywhere. Invisible to airport metal detectors. Cuts chain, rope, hand-cuffs, and padlocks. Weighs 1/2ounce, 5/16" thick, 3 1/4" long closed. Put it on your keychain, wear it around your neck on a cord, sew it into the lining of your jacket, or slip it into your sock. A useful survival/emergency repair tool for world travelers, sportsmen, and adventurers.

Don't get "caught" without it!
Only \$9.98 PPD. Two or more, \$8.49 each.

PAGER HOLSTER

FAST, SAFE, DISCREET. PRESS BUTTON AND FRONT OF CASE POPS OPEN AND HINGES DOWN. ALLOWING INSTANT DRAW OF GUN, CLIPS TO BELT. SPARE AMMO CARRIER INSIDE CASE. FITS DAVIS DERRINGERS, BABY JS AUTOS FROM PSP 2'S, BROWNING AND BAUER, NORTH AMERICAN AND FREEDOM ARMS 7.62R MINI-REVOLVERS, SHORT BARREL MODELS.

\$19.95 plus \$1.50 S&H, or two for \$34.95
SPLIT SECOND SECURITY, INC.
P.O. BOX 16142-S, HOUSTON, TX. 77222

W.W. II COLLECTORS OVER 40,000 ITEMS

Hats-Badges-Medals of all Nations. U.S. Officer's Cap (new from original U.S. maker), tan with brown leather visor, chin strap and U.S. Eagle pin. State size S, M, or Lg. \$58.00

We pay postage. Our 250 page fully illustrated catalog \$5.00 (Free with order)

W.W.#2 Ltd., Box 2063-T, St. Louis, MO 63158

NOTICE TO READERS
SOLDIER OF FORTUNE Magazine is a magazine of national and international distribution. There may be products for which sale, possession or interstate transportation may be restricted, prohibited or subject to special licensing requirements in your state. Purchasers should consult the local law enforcement authorities in their area.

BUMPERSTICKER PRINTER. Cheap, simple, portable. Free details. Bumper, PO Box 22791 ABM, Tampa, FL 33622. (160)

POLICE CN TEAR GAS for individual self defense. Retailers and distributors needed. Excellent profit. Free details. Atlas, PO Box 892, Lincolnton, NC 28092. (157)

SHOCKING MANUALS!!

Survival Electronics, Computers, Security, Weaponry, Rocketry, Phones, Energy, Financial, Medical. 100+ Plus Special Projects and Technical Research Services. Confidentiality Guaranteed! Send \$3 for catalogs. By John Williams, former Senior Engineer (Lockheed) and Computer Science Professor (NMSU) - as seen on CBS "60 MINUTES". Since 1971.

CONSUMERTRONICS

2011 CRESCENT DR. P.O. DRAWER 537
ALAMOGORDO, NM 88310 (505) 434-0234

CABLE TV DESCRABLERS!



NO CALIFORNIA SALES!!!

JERROLD™ · TOCOM · HAMLIN · OAK · SCIENTIFIC ATLANTA · ZENITH
6 month warranty! We ship C.O.D!
Lowest retail/wholesale prices!

FREE CATALOG:
Global Cable Network
1032 Irving St. Suite 109-E
S.F., CA 94122

ORDER TODAY! 415-566-9688

TELEPHONE RECORDING DEVICE. Why pay more? This device fits all tape recorders. Complete instructions. \$14.95 to Arthur Electronics, Box 15613, Minneapolis, MN 55415. (156)

WAREHOUSE YOUR ARMS AND VEHICLES — 186,000 square foot secure and private brick warehouse and land for sale. Central Massachusetts location. Convenient to major routes. Excellent loading, high ceilings, possible seller financing. \$3,500,000. Contact Steven Moskowitz, Broker (617) 232-9800. (156)

MINIATURE FM TRANSMITTERS: Tracking transmitters! Voice disguisers! Bug detectors! Phone snoops! More! Surveillance items available assembled or build them yourself. Catalog \$2.00: Xandi Electronics, Box 25647, Dept. 40E, Tempe, AZ 85285-5647. (156)

GI DOG TAGS — Two regulation issue tags with chains, tag silencers and P-38 can opener — \$7.50/set — Brass tags \$2.00 extra/set. INFO: up to 5 lines, 15 characters per line each tag. Mail to: GI Tags, 8190 E. Mira Mesa Blvd., Suite 135, San Diego, CA 92126. (156)

FREE

LEARN JUNGLE SURVIVAL IN TROPICAL COSTA RICA. For information write to: Jungle Survival, Apartado 7, Golfito, Costa Rica, Central America. (163)

FREE 40-PAGE PRIVACY CATALOG. Cash income opportunities. Secret loans. Home businesses. New credit, jobs, degrees, foreign passports. EDEN RESS, Box 8410-SR, Fountain Valley, CA 92728. (160)

FREE — See our large selection of citations, diplomas, awards for martial arts, military and much more! Archival quality. Fast service. Lettered to your specifications. Call or write today! Demographics, 3232 SW 35 Blvd., Suite 115, Gainesville, FL 32608. (156)

FREE THROWING KNIFE CATALOG AND INSTRUCTIONS. Send self-addressed, stamped envelope to: TruBal South, PO Box 1261, Cape Canaveral, FL 32920. (156)

FREE KUNG FU LESSONS Guaranteed satisfaction. Send \$1. for postage: McLisa, P.O. Box 1755 Dept. SF90-J, Honolulu, HI. 96806. (158)

INSTRUCTION

PRIVATE INVESTIGATION home study course. Free information, get started in a high paying career. Write Central Investigation, Box 1894A, Provo, UT 84603. (158)

JUNGLE SURVIVAL TRAINING Eight day expeditions. Belize, C.A. Instruction on surviving in jungle environment. Free Brochure. Pathfinder, PO Box 397, Clearwater, FL 34617. 813/855-3458. (156)

BECOME CERTIFIED Survival-Outdoor Specialist, Instructor —subscribe to Eagle-Eye Communicator, newsletter of first aid, medicine, edible plants, survivalism. \$17.50/year subscription. EEC Dealer Program — Power-30 Team, top 7 eligible as future paid advisors. EEC (SOF), PO Box 391, Jamestown, NY 14702-0391. (156)

YOUR VOICE CAN BE A POWERFUL WEAPON. Arcane technique render opponents helpless, confused. Cassette study course with instructions — \$39.95. Chromotone, 6201 Sunset #27(S), Los Angeles, CA 90028. (156)

KNIVES • BAYONETS

SURVIVAL MASTER by Saburo \$49.00. Phobis M9, \$89.00; CUK \$75.00; MFK \$49.00. Free catalog. C.J.C.S., Box 29003, San Diego, CA 92129. (156)

CHILEAN MAUSER BAYONET. \$18 prepaid. 48 states certified funds only. AK, HI, Foreign inquiries invited. Bacon Creek Gun Shop. PO Box 814-SDF, Corbin, KY 40702-0814. (158)

GI DOG TAGS

SET OF 2 Tags, long and short chain. 4 lines, 15 spaces per line. No extra charge for shipping or printing. Send \$6.95 to: DOG TAGS, 1703 Hwy. 218E, Dept. N, Monroe, N.C. 28110. Sent out the same day.

The Most Powerful Slingshot in the world



Silent
Accurate
Deadly 100% hand made in the USA

We Pay Postage

- * More "muzzle" energy than some .22 cal. cartridges.
- * Shoots 184 gr. lead ball (50 cal.) 200 ft. per sec.
- * Over 300 yard range.
- * Kill instantly grouse, duck, squirrel, rabbit, raccoon, cat, dog, fox, badger, even coyote.
- * Shoots 50 cal. holes clear thru 1/4" plywood.
- * Up to 50 lb. draw (can you pull it?).

!!WAR GAMES!!

Get new Pellet Pellet adapter and shoot 68 cal. pellets over 350 ft. Range 12" group at 100 ft.—Add \$5.00 for adapter.

!!WAR GAMES!!

Will Send C.O.D. 702-361-8341
Ron Sinclair 279 E. Warm Springs Rd. #6, Las Vegas, NV 89123



BUSHPILOT WINGS
BADGE QUALITY — CORROSION FREE RHODIUM
SEND \$6.95 TO: BUSHPILOT
P.O. BOX 541384
DALLAS, TX 75354-1384
CATALOG WITH PURCHASE — ALLOW 4-6 WEEKS

COLLECTORS ITEM "WAR'S OVER"



Original World War II Reprint Poster 17 1/2" x 22 1/2" printed in black & white on glossy stock, Limited Edition. Send \$10.95 plus \$2.00 shipping & handling to: ARLO PRESS INC., 59-25 Grand Avenue Maspeth, NY 11378

allow 4 to 6 weeks for delivery

COMBAT BLADES: KA-BAR USMC fighting knife \$32.00, British Commando knife \$27.00, USAF pilot survival knife \$18.00. All genuine. add \$3.00 each S&H. Granite State Ordnance, PO Box 189, Kingston, NH 03848. (156)

THROWING KNIVES. Great selection, excellent prices. Call or write for FREE brochure. Fantastic, 7727 Ave. M, Brooklyn, NY 11234. Phone (718) 251-2824. (156)

MISCELLANEOUS

ISRAELI MILITARY PRODUCTS: New, expanded catalogue. I.D.F. webbing, helmets, uniforms, insignia, T-shirts. Send \$2 (refundable) for catalog or \$12 for sample of 4 insignias. I.M.P., PO Box 31006, Tel Aviv 61310 Israel. (157)

MILITARY INSIGNIA CATALOG Over 6,000 different items and genuine military clothing and equipment. Send \$2. Kaufman's West Army & Navy Goods, Dept. A-521 1660 Eubank, Albuquerque, NM 87112. (156)

CRIMEFIGHTERS, INVESTIGATORS, SECURITY GUARDS, INTERESTED CITIZENS: International Institute of Criminologists and Private Investigators offers impressive, attractive certificate suitable for framing and ID card. Life membership \$39.00 + \$2.40 S&H. One year membership \$36.60 + \$2.40 S&H I.I.C.P.I.I., Dept 303, PO Box 575778, Salt Lake City, UT 84157. (156)

FATHERS: WIN primary custody of your precious children! Valuable information most Attorneys neglect to mention. How to find a Lawyer that will really fight for you. Super facts that will greatly strengthen your position. \$24.50. I.I.C.P.I.I. Dept 303, PO Box 575778, Salt Lake City, UT 84157. (156)

SURVEILLANCE COUNTERSURVEILLANCE EQUIPMENT CATALOG. \$5.00. Transmitters, debugging, books, night vision. Eavesdropping Detection Equipment, PO Box 1087, Williamsville, NY 14231. (156)

ARREST Violators! Wear the Badge of a DETECTIVE



NO PREVIOUS TRAINING NEEDED

Your spirit of adventure, danger, and self reliance can lead you to an exciting career opportunity. Solve mysteries, bring criminals to justice, protect the innocent. Experts guide you every step of the way. Men and women needed to work in challenging situations, withstanding hardships, make on the spot decisions. Learn the latest investigative techniques using special law enforcement equipment . . . the same equipment

used by the FBI, the CIA, and the Secret Service. Start your own investigative agency. Save up to 25% and more on all equipment. Send for free details

Approved by Calif. Dept. of Public Instruct.

THE ROUSED SCHOOL of Special Detective Training
DEPT. SG009 P.O. BOX 23750, Santa Ana CA 92799

Rush me your "Detective" Career Kit—No salesman will call.

Name _____ Age _____

Address _____

City/State/Zip _____

FREE CATALOG

UNIQUE

ESPIONAGE & MILITARY MEMORABILIA

Historical Military Art and Collectibles
P.O. BOX 1806 - SF Lafayette, CA 94549
Phone 24 hours (415) 283-1771

Electronic Bug \$24.95



As you can see, the FM EAR is small. But it can pick up every whisper in a room and transmit it a block away to your FM radio. Sound quality is excellent! It's easy to use, just snap it on a 9 volt battery and hide it. Notice: This device is only to be used in conformity with Federal, State and Local laws! The FM EAR is intended for security use only, such as listening for suspicious sounds in your garage or R.V.

GUARANTEE: If you're not completely satisfied with the FM EAR, just send it back in 30 days for a full refund!

Fast
10
Day
Delivery

(To Order)
Send a \$24.95 check or moneyorder to
MATSON ELECTRONIC MFG.
1269 Broadway
Suite 196, Dept. B1
El Cajon, CA 92021

REGIMENTAL INSIGNIA & WEAPONRY



- SAS • RAF • BLACK WATCH
- PARA • RM • CAMERONS
- RSDG • RN • GUARDS etc.

Import Catalog \$3.00

BRITISH REGIMENT IMPORTS
Department-6
P.O. Box 50473 • Nashville, TN 37205

SURVEILLANCE, counter-surveillance, weapons, books! Guaranteed lowest prices! Huge catalog \$5.00 (refundable). Protector, PO Box 520294-C, Salt Lake City, UT 84152. (157)

CAMOUFLAGE British Flaklands, Rhodesian (original), Spanish, French Algeria. Please send \$2 bills only for photos/details. Embleton, Hollybush Lodge, Firgrove Road, Yateley, Hants, England GU177NH. Phone 252 892913. (157)

SURVIVALIST SMOKED MEAT STICKS — as used by the military USDA approved. 100% natural "could save your life." Variety packs 10 sticks \$8.50, 20 sticks \$13.50. Country Meats, PO Box 263, Citra, FL 32113-0263. (156)

WORLDWIDE CAMO CAPS, French F-1 \$16.00, Portuguese Bigeard \$21.00, German Tan & Water \$22.00, French Bigeard \$21.00, German Lektar \$22.00. A.H.A., Box 21606, Denver, CO 80221. (156)

LAW BADGES AND PATCHES send \$1 for list or \$8 for 12 monthly list. BPEC, DEPT. SN1288, Box 7638, Moreno, CA 92303 (156)

CREOLE/CAJUN cooking at it's finest. 10 Recipes \$5. Canal Louts, Box 8371, Mobile, AL 36608. (157)

CUSTOM EMBROIDERED EMBLEMS, pins. Made from your design. Highest quality/lowest prices. Free catalog. Stadr, 615F Jane, NYC 10014 (212) 929-2293. (158)



WW 2 GERMAN MILITARIA
Uniforms, hats, insignia books, posters, T-shirts
Camouflage smocks, hats and helmet covers
KRUPPER Box 177-SFA
Syracuse NY 13208 USA

FIRE THE WORLD'S MOST POWERFUL AIRGUN
Scope \$19.95
\$129.95



Kill Big Game Or Small Game High Impact Energy, No Flash No Smoke, Low Noise Fire As Rifle Or Shotgun Make Your Own Ammunition Launch Animal Capture Nets Call For Free Brochure.

AIRPOWER SABOT CANNONS
707 Wells Rd, 1SOF, Boulder City NV 89005
Visa & Mastercard Accepted 1-702-294-0100

SURVEILLANCE TELEPHONE



This is a normal functioning telephone! EXCEPT it has a secret built in monitor. Only YOU can call and monitor all conversations, using a secret code, and never be detected! Range Unlimited
\$175.00 - 6 month Warranty - Phone Tap Catalog \$3.00
LISTEN ELECTRONICS, 603 Elgin, Muskogee, OK 74401
1-800-633-TAPS

Subscribe to...

MILITARY VEHICLES

ADS ARTICLES NEWS

MILITARY JEEPS, TRUCKS, TANKS & MORE!
Over 5,000 paid subscribers larger circulation than any other magazine for military vehicle enthusiasts... and still growing rapidly! Many more advertisements than any other magazine... Exclusive comprehensive listing of upcoming rallies... and much more!



SUBSCRIBE NOW!

One Year (6 Issues) \$12
Two Years (12 Issues) \$20
Foreign - Canada \$15, other \$20
US Dollars payable by US Bank
Sample Issue \$3 USA, \$5 outside

P.O. Box 1748-L, Union, NJ 07083

NOTICE TO READERS
SOLDIER OF FORTUNE Magazine is a magazine of national and international distribution. There may be products for which sale, possession or interstate transportation may be restricted, prohibited or subject to special licensing requirements in your state. Purchasers should consult the local law enforcement authorities in their area.

R&R didn't end with Vietnam. Single men can enjoy a playful vacation in the Philippines. Our personalized package includes hotel, drinks and your choice of exotic oriental escort for every day of your stay. Vacation, Box 43, Bellerose, NY 11426. (156)

Machine Gun News
Machine guns... and more.

Everything you want to know about suppressors, machine guns, and other Title 2 firearms. Each monthly issue features informative articles, entertaining reports from machine gun shoots, plus hints, tips and advice that you won't want to miss. So for a revealing and entertaining look at the guns like you've never seen them before subscribe to Machine Gun News.



Your source for everything automatic! Special Introductory Offer! Now for a limited time, you can subscribe and save \$5. off the regular subscription price of \$29.95. Just \$24.95 for a 1 year (12 issue) subscription. Subscribe Today!
Machine Gun News
PO Box 761 Dept. SF Hot Springs, AR 71902
(501)623-4951
To ensure your privacy M.G.N. is mailed with a protective cover Foreign subscribers add \$20. U.S. Funds only please

LATEST MODEL 6 SHOT ITALIAN AUTOMATIC TEAR GAS GUN

ONLY \$995 POSTPAID

Fires 22 cal. tear gas or blank ammo. Solid metal. 6 shot, clip fed. Rapid firing. With instructions. For self-protection, theatre, dog training, sports. Purchaser must be over 21. Money back guarantee.



WESTBURY SALES CO.

Dept. TA-10-SF 156 Post Avenue, Westbury, New York 11590

U-BOAT CAPTAIN'S CAP



White top Gold insignia and visor braid Leather chin strap State size wanted \$89.00

Knights Cross with its 17" neck ribbon and oak leaf with swords \$21.00

We pay postage. Our 224 page fully illustrated catalog (free with order) \$5.00

OVER 40,000 Items.

W.W. #2 Ltd., Box 2063-F, St. Louis, MO 63158

BLANK DD214's: \$20, combat certificates, good conduct thru MOH. Blank \$20. Customized \$50. You supply names, ranks, services, SNs, dates, time, brief of detailed account of action or citation. We will customize your award complete with signatures. These certificates look better than the genuine U.S. Government issue medals. Write for details. Officer's commission, blank \$20. Typed and signed \$35. Promotion warrants, all grades E-1 thru General, \$20 Blank, \$35 Typed and signed. R&H Publications, PO Box 149, Springdale, AK 72765.(156)

SECRET SCANNER FREQUENCY Director's! Federal, Police, Surveillance, Survival, Military, Car Phones, More! Big catalog! CRB, PO Box 56-F, Comstock, NY 11725. (162)

CRIMEFIGHTERS send \$2. for police catalog. B-PEC Dept. SF 1189, Box 7638, Moreno, CA 92303 (164)

MEN ATTRACT WOMEN! K2ryma, a scientifically verified sexual pheromone, androsteneone, scentiously lures women to you like wild! Guaranteed — period. Rush \$27.95 plus \$2.00 shipping: XTZ Products, PO Box 867461-S, Plano, TX 75086. (156)

INTERNATIONAL INVESTIGATORS' NEWSLETTER: Two issues \$2.00. Licensing Guidebook (PIs, FFIs Weapons) \$14.95. Police Badge Catalog \$1.00. Eagle, (S)Box 6303, Corpus Christi, TX 78466. (158)

EXOTIC MINIATURE SURVEILLANCE DEVICES. Catalog \$4.00, refundable. F&P Enterprises, Box 51272, Palo Alto, CA 94303-C. (158)

BACKGROUND INFORMATION: Individual locator, hidden bank accounts, credit checks, driving records, criminal histories, corporate records, more, nationwide searches, moneyback guarantee. \$5.00 for package, Jerin Security, 15000 Mack, Detroit, MI 48224. (159)

INCREASE YOUR CHANCES OF SURVIVAL! Get on the National Survivalist mailing list. Enclose \$2.00 for processing to: Battalion Quartermaster, Dept. SOF, PO Box 370, Blair, NE 68008. (156)

COMBAT COLLEGE, list of courses \$2.00 (refundable) Agent orange map — free to Vietnam Vets. Allied, Drawer 5070-F, Glendale, AZ 85312. (156)

TELEPHONE LISTENING DEVICE



Record telephone conversations in your office or home. Connects between any cassette or tape recorder and your telephone line. Starts automatically when phone is answered. Records both sides of conversation. Stops recorder when phone is hung up.

\$19.95 EACH Qty Disc Avail



Super Powerful FM TRANSMITTER

Many times more powerful than other transmitters. Transmits up to 1/4 mile to any FM radio - Easy to Assemble Kit - up to 9V battery (not incl.) For catalog of Transmitters, Voice Scramblers and other specialty items, enclose \$2.00 to USI Corp

Call 407-725-1000 or send \$19.95 + \$1.00 shipping per item to: USI Corp., P.O. Box SF-2052, Melbourne, FL 32902 COD's OK.

THE SPOOK BOOK

A Strange and Dangerous Look at Forbidden Technology
Mick Tyrer

FORBIDDEN TECHNOLOGY: A STRANGE AND GENUINELY DANGEROUS LOOK • Building Teflon™-Coated Bullets • Jamming Speed Radar • Titanium Warheads • Activating Inert Grenades • Hyperspace Encryption • Rocket Weapons • Clandestine Pyro Explosives • Wearing A Wire • Defeating Alarms • Forbidden Tech Marketplace • Surveillance Photography • Computer Viruses • Scrambling/Descrambling • Ultrasonic Weapons • More! 8.5x11, 258 meaty pages. A Fresh & Luscious Look at Forbidden Technology! \$33 domestic postage paid. Registry Distributing, 1618 17th St, Ste 372, Denver, CO, 80202. Sold only to inform.

PERSONAL PROTECTION ITEMS — Pocket size, ensure your safety. Free catalog. Fisher Company, 5610 Boxborough, Dept. 100, Greensborough, NC 27407. (156)

FIREWORKS. We ship to your door. Low prices. Bottle rockets as low as 99c a gross. Catalogs and info call 1-900-USA-1776. (156)

CIA-SOG CARD. Famous "Get out of Jail Free" Vietnam spy card \$3.00 (two for \$5.00). Lone's, Box 998(FJ), El Segundo, CA 90245. (156)

DEBTS? BILLS PILING UP? Bad credit is no problem. We'll help. Licensed/Bonded. Apps accepted \$500-\$50,000. Not a loan company. UAC, Dept. SF, PO Box 26295, Birmingham, AL 35226 or call (205) 822-8284. (156)

NUCLEAR WAR!! Nuclear fallout shelter, GN-820 Surplus, \$7.95. PO Box 4105, Youngstown, OH 44515. (156)

DRUG TESTS FOR CONGRESS. Congress thinks it's the thing for millions of us! What have we done to deserve this outrageous infringement of our rights? If drug tests are good enough for us aren't they good enough for congress? Let your opinion be known. To receive the above bumper sticker, send \$3.00 to: Constitutional concern, PO Box 350-447, Ft. Lauderdale, FL 33335. (156)

HOW TO OBTAIN BIRTH, DEATH, MARRIAGE, DIVORCE & ADOPTION RECORDS. Reference source for anyone searching for old friends, relatives, lost loves or anyone else whom they desire. You will learn where to look state by state for these important records. Send \$9.95 plus \$1.75 postage. Books of Intrigue, Dept. B, 13575 Martinique, Chino Hills, CA 91709 (CA residents add sales tax). (156)

YOU CAN FIND ANYONE! Secretly obtain unlisted phone number, confidential postal and DMV records, birth/death, credit and confidential court records. Author reveals every source, method and trick known. Locate old friends, lost lovers, debtors and enemies. For profit, fun or adventure. Satisfaction guaranteed. Send \$14.95 plus \$1.75 postage. Books of Intrigue, Dept. B, 13575 Martinique, Chino Hills, CA 91709 (CA residents add sales tax). (156)

SURPLUS

ARMY SURPLUS: Large Inventory New and Used, Plus Survival Items. Send \$1 (Refundable) for Price List: Hugh Wade's Oakshire Place, Hwy 51 South, Union City, TN 38261. (156)

GENUINE MILITARY CLOTHING, GEAR, EQUIPMENT AND INSIGNIA. Our name has meant quality for over 65 years. Catalog, \$2. Kaufman's West Army & Navy Goods. Dept. A-221, 1660 Eubank, Albuquerque, NM 87112 (156)

ATTENTION OVERSEAS CUSTOMERS. Will buy, sell, broker military surplus, etc. Leonard Elliot, PO Box 814, Corbin, KY 40702-0814 USA. (156)

SOVIET MILITARY GEAR, Large Listing of Genuine Soviet Camo. Equipment, Uniforms etc... NEW LOWER PRICES!!! \$1.00, or Army Cap Badge & Catalog for \$5.00. A.H.A., Box 21606, Denver, CO 80221. (156)

SURVIVAL

SMOKE GENERATING DEVICES (Candles, bombs, pots, Grenades) — Send \$2.00 (receive \$5.00 credit) for catalog of these and much, much more! Signus, Box 33712-W9, Phoenix, AZ 85067. (156)

SURVIVAL and primitive skills — how-to books to give you the edge. Kits, plans and ready made "Aztec" spear throwers. Survival, Box 110755, Aurora, CO 80042-0755. (157)

WE OFFER you discounted survival products! Plus, correspondence across the nation in our Big Newsletter with informative articles. Send \$2.00 for information and newsletter. National Survivalist Association, Dept. 25F, Box 6921, Lake Charles, LA 70606. (156)

SURVEILLANCE

SHERWOOD - The first name in surveillance equipment. Complete line of investigative, communications & countermeasures equipment.

CONTACT THE SURVEILLANCE SPECIALISTS

SHERWOOD COMMUNICATIONS ASSOCIATES, LTD.
PO Box 5358, Southampton, PA 18966
(215) 357-9065

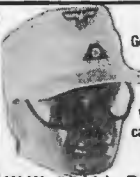

AFRICA-KORP. CAP & GOGGLES

German 1942 Mfg. ORIGINAL sand & dust goggles, still in their pocket pouch.

Tan Otc. caps = New REPLICA. State S-M or Lg. Size. Both - Only \$39.00

We pay postage Our 250 page fully illustrated catalog \$5.00 (FREE with order)

OVER 40,000 ITEMS IN STOCK

W.W. #2 Ltd., Box 2063-F St. Louis, MO 63158

SOF CLASSIFIEDS WORK

EMERGENCY CANDLES. Made of high melt point micro-crystalline wax. Two candles per box. Over 120 hours burn time. Excellent for home, car, camping, etc. Send \$7.95 + \$2.50 S&H to Battlesight Supply, PO Box 16043, Colorado Springs, CO 80935. (156)

TRAINING

RANGER, AIRBORNE, BODYGUARD Training. Catalog and information \$6. (10. foreign). USTC, 2020 N. Broadway, Ste. 103, Santa Ana, CA 92706-2622. (158)

US NAVY SEAL FITNESS PROGRAM. Gain strength and self confidence. Get in shape using the methods of the world's most elite combat unit. Send \$10.95 to T-N-S Ent., PO Box 5644, Virginia Beach, VA 23455. (157)

SPECIAL OPERATIONS FIELD TRAINING: Training in the following: 2-Member Alpine LRRP Techniques; Advanced Land Navigation/map/compass; US/NATO/SOVIET weapons familiarization; basic-advanced rappelling. Solo wilderness survival course. Precision rifle course. Mobile training teams also available. Ranger Outreach Center, PO Box 1164, Dept. SOF, Pecos, NM 87552 USA. (156)

LEARN HOW TO SURVIVE MARINE CORPS BOOT CAMP. I was there! I'll reveal the secrets to graduate basic training a winner. Send \$3.00 with SASE to Cpt. Jeff Gance, 4823 Carfax Ave., Lakewood, CA 90713. (158)

FREEDOM COUNTRY



20 BIG acres in WESTERN MONTANA, starting at \$9850. Trout fishing, backpacking, camping. Elk, deer, moose, bear. ADJACENT to National Forest, near established towns. Yellowstone and Glacier National Parks nearby. GUARANTEED ACCESS, INSURED TITLE, WARRANTY DEED. FREE color brochure, photos, maps.

FULL MONEY-BACK GUARANTEE
"Video Available"
CALL TOLL FREE 1-800-592-5990
TREASURE STATE RANCHES
210 Milwaukee Street, Dept. S
Deer Lodge, Montana 59722 — (406) 846-1000

EDINBURGH MILITARY TATTOO

VHS ONLY on Video for the first time **\$39.95**

75 minutes of pageantry, precision formation marching and military ceremonial splendor.

BRITISH REGALIA IMPORTS
Department 6
PO. Box 50473, • Nashville, TN 37205

SUPPORT SOF ADVERTISERS

VEHICLES

IS IT TRUE you can buy Jeeps for \$44 through the U.S. Government? Get the facts today! Call 1-708-742-1142 Ext. 331-A. (156)

GOVERNMENT SEIZED VEHICLES FROM \$100. Chevys, Mercedes, Corvettes, Lincolns. For info call anytime (201) 485-0198. Ext. B115. (156)

VIDEOS

POOR MAN'S JAMES BOND AND CEP videotapes. On VHS PAL (Europeans, Australian etc. format) AIR, Sorgardsv. 12, 44500 Surte, Sweden. (156)

BE A PARALEGAL!

America's No. 1 home study paralegal program. Attorney-instructed. Prepare now for your law career! **School of Paralegal Studies**, Dept. UK171 2245 Perimeter Pk., Atlanta, GA 30341. Or call today.

FREE CAREER BOOKLET: CALL 800-223-4542



YOU TOO LAW ENFORCEMENT OFFICER CAN BE A or CIVIL INVESTIGATOR

HIGH EARNINGS! Learn about opportunities in LAW ENFORCEMENT!

YOU may be eligible to train at home for a career in LAW ENFORCEMENT or CIVIL INVESTIGATION. Enjoy **GOVERNMENT WORK, HIGH PAY, SECURITY, PENSIONS, PAID VACATIONS, SICK LEAVE, PROMOTIONAL OPPORTUNITIES, and FAMILY PROTECTION** that these Law Enforcement jobs offer.

Rush **INFORMATION** (no obligation) how I may train for a career as a Peace Officer or Private Detective. Dept. of Qualifications-Peace Officer Training Service, P.O. Box 185, Hope Mills, NC 28348.

Name _____
Street Address _____
City _____ State _____ Zip _____

U.S. MILITARY INSIGNIA

1940 through Current

Large Catalog, \$2.00

SAUNDERS
Box 3133 • SF • Naples, FL 33939-3133

ADVERTISERS INDEX

| ADVERTISER | PAGE |
|-------------------------|-------------------|
| API Marketing Inc. | 110 |
| Al Mar Knives | 36 |
| American Historical | 13 |
| American Pistol Inst. | 128 |
| Arapaho Trading Post | 127 |
| Barnett Int'l | Back Cover |
| B-Square Co. | 109 |
| Brigade Quartermaster | 123 |
| CEP Inc. | 108 |
| Camillus Cutlery | 125 |
| China Sports Inc. | 118 |
| Collector's Armoury | 132 |
| Combat Exchange | 19 |
| Conservative Book Club | 9 |
| Cutlery Shoppe, The | 126,128,130 |
| Danner Shoe Mfg. | 113 |
| David Steele Ent. | 133 |
| Delta Press | 122 |
| Doubleday Book Club | 7 |
| Dutchman, The | 25 |
| Eagle Arms Inc. | 29 |
| Excalibur Enterprises | 116 |
| Executive Protection | 111 |
| Franklin Mint, The | 15 |
| Frank's Center, Inc. | 120 |
| Glock Inc. | Inside Back Cover |
| Greene Military | 114 |
| Guardian Prod. | 115 |
| Gun South Inc. | 20 |
| Gun Week | 120 |
| Hayward, Carson & Sober | 123 |

| | |
|-------------------------------|---------------------------|
| Heckler & Koch | 17 |
| Int'l Security Services | 125 |
| Intratec | 14 |
| Kaufman's West | 119 |
| L.L. Baston Co. | 131 |
| L.O.T.I. Group Ltd. | 130 |
| Mil-Time | 133 |
| Orpheus | 128 |
| PCS-USA | 31 |
| Paladin Press | 5 |
| Pioneer & Co. | 131 |
| Police Bookshelf | 122 |
| Roots Research | 22,23 |
| SOF Convention | 28 |
| SOF Back Issues | 124 |
| SOF Exchange | 10,11,112,117,129,132,137 |
| SOF Sweepstakes | Inside Front Cover |
| S.T.A.N.O. | 14 |
| Shotgun News | 126 |
| Springfield Armory | 27 |
| Spye Knife Co. | 112 |
| Sturm, Ruger & Co. | 34 |
| Thompson Cigar Co. | 127 |
| Thunderzap | 33 |
| Universal Military Outfitters | 110 |
| Willabee & Ward | 37 |
| Women & Guns | 132 |
| Your Supply Depot | 121 |

SUPPLY LOCKER

| | |
|------------------|-----|
| American Schools | 138 |
|------------------|-----|

| | |
|------------------------------|---------|
| Auto Ordnance Corp. | 138 |
| Ballard Cutlery | 138 |
| Brigade Security Forces | 134 |
| Captain Humble Ind. | 138 |
| Cloak & Dagger | 135 |
| Combat Medicine Workshop | 136 |
| Eden Press | 136 |
| Exerciser, The | 137 |
| Firearms Graphics | 138 |
| Gun Parts Corp. | 137 |
| Ideal Studios | 138 |
| Jimmy Lile Handmade Knives | 137 |
| LRRP Security Services | 135 |
| Leeward Press | 137 |
| Legendary Arms Inc. | 135 |
| Marathon Press | 134 |
| Mathews Police Supply | 136 |
| Max Capacity Products | 134 |
| Missouri Wilderness Cat. Co. | 135 |
| Nat'l. ID Center | 135,136 |
| Para Combativ | 134 |
| Prestige Shirt Co. | 134 |
| Quartermaster Military | 136 |
| Rega 3 Inc. | 136 |
| SOS Inc. | 135 |
| Sierra Supply | 134 |
| Survival Books | 134 |
| U.S. Cavalry Inc. | 137 |
| USI Corp. | 137 |
| WKE Ltd. | 138 |
| Westbury Sales | 135 |

types who put us up in a local motel. The next day the debriefing began and for two days we sat through long periods of questions about the Afghan war, the Russians, their equipment and what we brought back. It struck us funny that the agents didn't care about the laws that might have been broken getting the samples into the United States. They were concerned about the filter, however, and began making overseas calls to locate it.

Following the debriefing Brown and I returned to Washington and turned a few rounds over to the National Rifle Association for testing and briefed Rep. William Dickinson (R-Ala.), a member of the House Armed Services Committee, about the trip, filter and ammo.

On following trips to Washington, Brown and I learned that the U.S. Counsel in Peshawar was claiming he had obtained the filter for the U.S. government. Also, in the congressman's office, several ranking military officers squirmed in their seats while the congressman forced them to admit that SOF had scored a major intelligence coup with the ammunition and filter. Attempts by some disgruntled member of the U.S. military community to dismiss the filter's value were rejected and the proof was a \$15,000 check for the filter Brown and I received from a government-owned dummy corporation.

— Galen Geer ✕

FLASHPOINT LIBERIA

Continued from page 53

Monrovia waits.

Thorn Green has written for newspapers from the Rockies to the West Coast since the early 1950s.

AMERICAN MERC — TAYLOR'S STRATEGIST — KILLED

Charles Taylor was not the first Liberian to become disenchanted with Samuel K. Doe's "revolution" and subsequent usurping of the Liberian government. During an overthrow attempt in November 1984 one William Henry Woodhouse, an American and former Marine, was wounded in a Monrovia shootout with police. Also wounded in the shootout and arrested with Woodhouse was a dual Liberian/American national and U.S. Army veteran Elmer Glee Johnson. In April 1985 Woodhouse, paralyzed from wounds sustained in the shootout, and Johnson who reportedly lost an eye in the firefight, were sentenced to prison by the Doe government.

The prosecution had alleged that in October 1984 Johnson had hired Woodhouse for the prodigious sum of \$200,000 to help a group of Liberian soldiers overthrow Doe and install a

Marxist regime led by Johnson. Johnson served 12 months in prison before being released in a general amnesty brought about by pressure from the United States, but this was not the last time Samuel K. Doe would have to worry about Elmer Johnson.

Born in Liberia as the grandson of a former Liberian vice president, Johnson came to the United States with his family when he was nine years old. He was raised in the Boston area and graduated in 1977 from Boston University with a degree in political science. He received a master's degree in public administration from Suffolk University in 1986.

In between, Johnson returned to Liberia, was married, but fled after Doe's 1980 coup. While living in the Boston area, Johnson enlisted for a hitch in the U.S. Army — which included the invasion of Grenada — reportedly getting out with the rank of sergeant. Out of the Army, Johnson returned to Liberia in 1984 to become involved with the overthrow attempt that got him shot up and jailed. Returning to the United States after the general amnesty, Johnson earned his degree at Suffolk while working as a speech writer for Massachusetts Senator John Kerry, and was active in the campaign to re-elect him. Family sources stated that Johnson had been a friend of Charles Taylor for some 18 years, remained in close contact with him, and had returned to Liberia early in 1990. Former teachers, associates and family members all describe Johnson as a serious, thoughtful man who was very much dedicated to the cause of ridding Liberia of Samuel Doe.

When Charles Taylor first invaded Liberia with a very small band last Christmas Eve, all appearances were that they had little organization, little strategy, and what support they had came from Libya — not something that would endear the group to the U.S. government. As events sort themselves out, however, it appears possible that although Taylor and his men have received training and some aid from Khadaffi, it may well have been only the pro-forma aid Khadaffi would give to any group that was interested in overthrowing any existing government.

As Taylor's rebels advanced across Liberia, it became apparent they indeed had a great deal of support, and that most of it came from the Liberian people. It also became obvious that they had a sound military strategy — and that their military strategist was Elmer Glee Johnson, who was chief military adviser to Taylor.

On 4 June 1990 Johnson was killed in an ambush by counterattacking government troops between Roberts Field and the Firestone plantation, a few miles from the port city of Bu-

chanan. Taylor's troops had taken Buchanan on 19 May, with little resistance from the 2,000 fleeing government troops. Several days later, however, some 500 government troops counter-attacked, and Johnson, who was leading a convoy of 30 rebels in captured government vehicles, was killed. Shot in the head execution-style, Johnson's remains were found by rebel troops and identified by personal papers, including his Massachusetts driver's license.

Rebel troops told reporters that Johnson had been the cohesive force that held them together, instilling discipline in the field, and attempting to stop looting. Samuel Dokie, second in command to Charles Taylor, stated, "Our victories prove that we are winning. Elmer's death is a propaganda victory for Doe, but it happened while his soldiers were running away from Buchanan after we had taken the city. Elmer's death is a great loss. But it is not the end and we will continue the struggle. We already have other military commanders in the field who are taking over from Elmer. The Battle is just beginning."

— Don McLean ✕

WORLD SITREP

Continued from page 8

three days to unseal his lips ... Catalan separatist blew off both legs while planting bomb outside courthouse ... **SRI LANKA:** government troops blasted and burned Tamil Tiger bunkers east of Colombo, while Tamil rebels rocketed and mortared government troops in fighting that has cost over a thousand lives since early June ... **SUDAN:** coup failed, officers involved in attempt rounded up ... **TONGA:** four Kiwis deported amid rumors of assassination squad arriving to do in King Taufauhau Tupou IV and launch coup ... **TURKEY:** masked gunmen from Union of Turkish Islamic Commandos shot news editor Cetin Emec ... **UGANDA:** Sports and Culture minister charged with plotting overthrow, terrorist acts ... **USSR:** troops sent to quell 2,000 rioting inmates at Dnepropetrovsk ... Sov officials seeking international aid in evacuating 2 million Byelorussians at cost of \$70 billion from areas contaminated by Chernobyl fallout; party line first was "no sweat" — now it's "no survivors" ... 59 military officers killed by folks on the street in 1989, only two in 1988 ... anarchy lives: Confederation of Anarcho-Syndicalists (KAS) party holding demonstrations and public meetings ... *Moscow News* broke story of hundreds of Sovs killed to test exotic weapons, poisons under Uncle Joe et al. ✕

SOMEDAY ALL HANDGUNS WILL BE THIS GOOD.

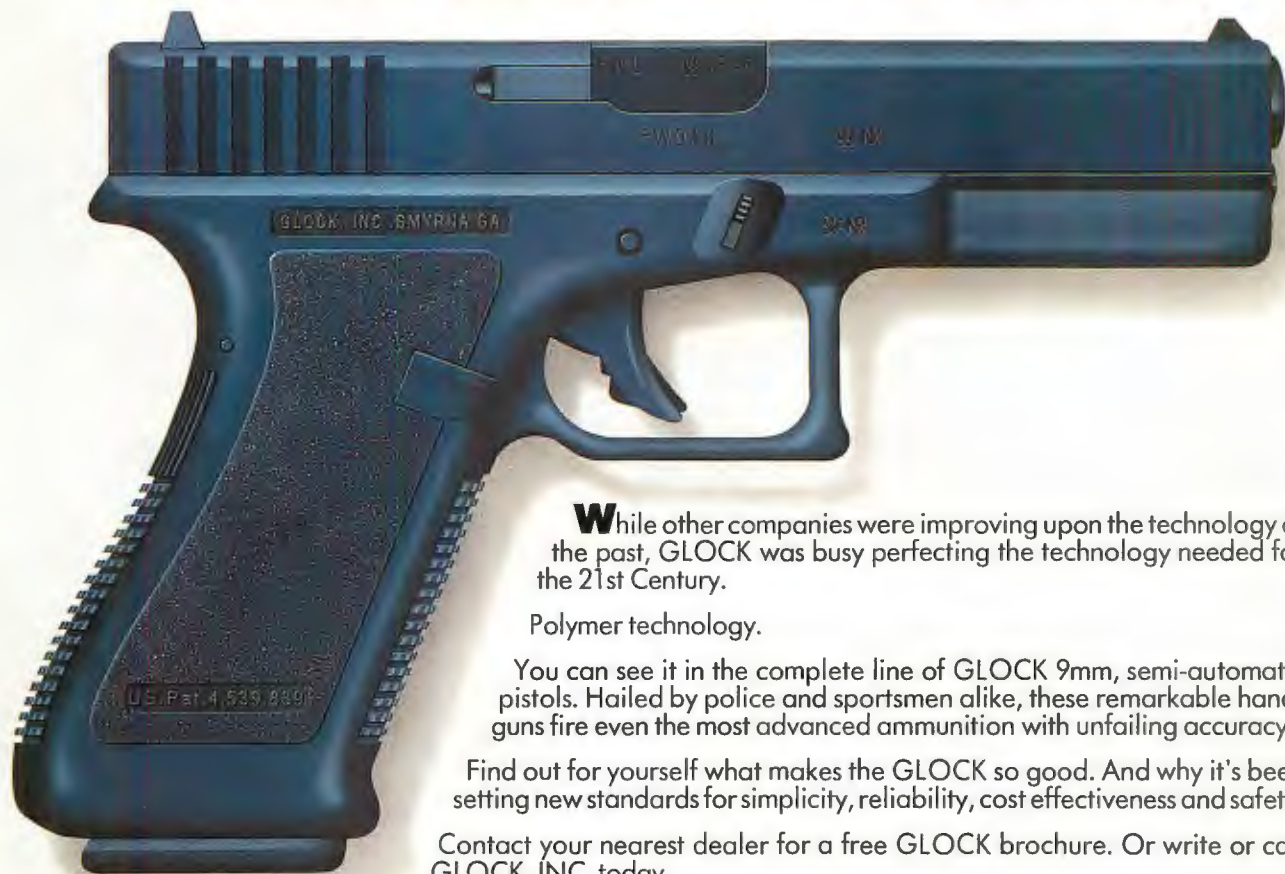

While other companies were improving upon the technology of the past, GLOCK was busy perfecting the technology needed for the 21st Century.

Polymer technology.

You can see it in the complete line of GLOCK 9mm, semi-automatic pistols. Hailed by police and sportsmen alike, these remarkable handguns fire even the most advanced ammunition with unfailing accuracy.

Find out for yourself what makes the GLOCK so good. And why it's been setting new standards for simplicity, reliability, cost effectiveness and safety.

Contact your nearest dealer for a free GLOCK brochure. Or write or call GLOCK, INC. today.



GLOCK® INC.

P.O. Box 369 • Smyrna, Georgia 30081 • (404) 432-1202
Telex: 543353 Glock Atl UD • Fax: (404) 433-8719



NO POSTAGE
NECESSARY
IF MAILED
IN THE
UNITED STATES

BUSINESS REPLY MAIL

FIRST CLASS MAIL PERMIT NO.A-453 PORTLAND, OREGON

POSTAGE WILL BE PAID BY ADDRESSEE

Danner

DANNER SHOE MFG CO
PO BOX 30148
PORTLAND, OR 97230-9907

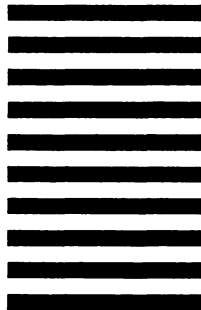



**NO POSTAGE
NECESSARY
IF MAILED
IN THE
UNITED STATES**

BUSINESS REPLY MAIL
FIRST CLASS MAIL PERMIT NO. 8 MT. MORRIS, IL

POSTAGE WILL BE PAID BY ADDRESSEE

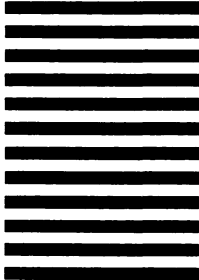

**SOLDIER OF
FORTUNE**

PO BOX 348

MT MORRIS IL 61054-9817



SPECIAL HOLIDAY GIFT OFFER

A **GIFT** OF **SOLDIER OF FORTUNE**

FOR AS LITTLE AS **\$19.95**

Save up to 57% off one-year single-copy price*

First Gift — \$24.95⁺

Additional Gifts — \$19.95⁺

Given By: _____

name (please print)

address

city/state/zip

Check enclosed (US funds only) Charge my **VISA** **MC**

XSBA0G

Card # _____ **Exp. date** _____ **Signature** _____

SEND TO: (A gift card will be sent to announce each gift)

Gift #1 _____

Gift #2 _____

address

address

city/state/zip

city/state/zip

XSBA0E

Payment must accompany order. *Offer good in U.S. only. All other countries add \$21.00 each for postage. Allow 6 to 8 weeks for first copy. *Savings based on annual newsstand rate of \$47.40. Expires 1-31-91

LOOKING FOR EXCITEMENT...

Some of the world's most exciting people hunt with Barnett crossbows.



With almost 4000 horsepower under the hood, K.C. Spurlock enjoys blasting down the quarter-mile strip at over 280 mph in his nitro-fueled funnycar.

It's pure exhilaration from the time he puts his helmet on until his car rockets across the finish line. So, what does he do for excitement away from the raceway? He shoots a Barnett Demon crossbow 280 feet per second (fps).

K.C. discovered the Demon is a power-packed hunting machine - which delivers maximum performance and accuracy. The sharp, modern crossbow features an improved prod and is available in a 150 lb. draw weight - making it one of the fastest, smoothest and most powerful compound crossbows available.

Visit your local Barnett dealer today... Or write or call for a FREE, color catalog featuring Barnett's complete line of exciting hunting and recreational products.

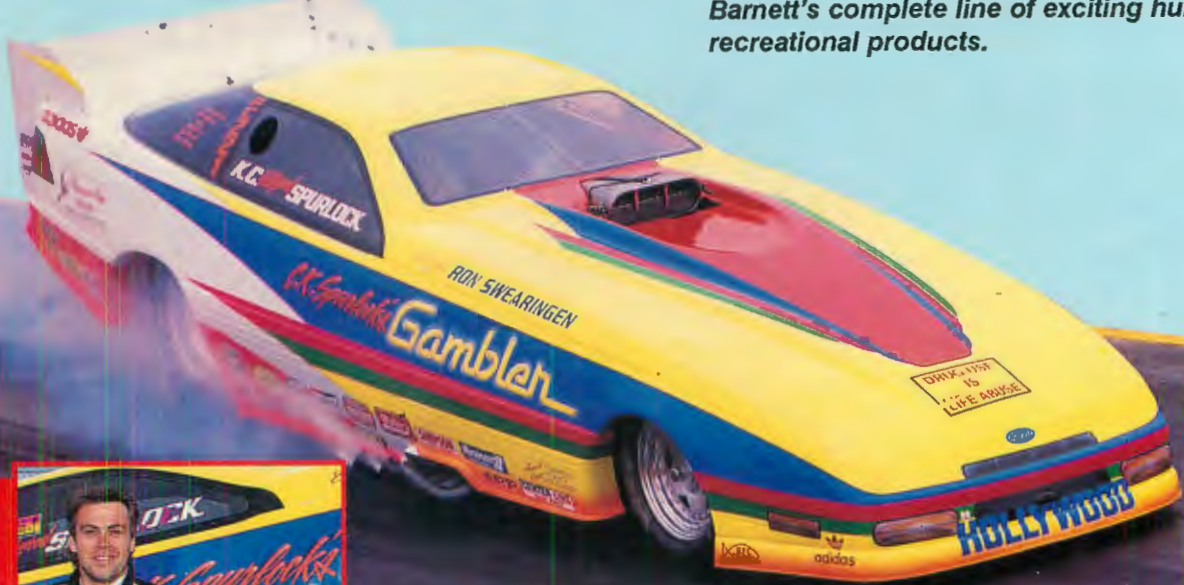

**K.C. SPURLOCK,
FUNNYCAR DRIVER**



Barnett International Inc.

P.O. Box 934, Dept. SOF/Odessa, Florida 33558
(813)920-2241